

10. CAUTION

1. When the temperature is too high, HI will be displayed in the temperature area to express the room temperature over the display range. When the temperature is too low, LO will be displayed in the temperature area to express the room temperature below the display range.
2. Two AA batteries can be used for one year. When the battery voltage symbol flashes, it means the batteries need to be changed. Please change the batteries sooner.
3. Within the 20 minutes after remove the batteries, time and week will keep running. Please change the batteries in this period.
4. There is preservative on the LCD when out of the factory, users can remove it or not.
5. If you need to remove the preservative, just pull it from the corner and no need to open the thermostat.
6. Don't force to install. When it is hard to connect the pin, move the display panel slightly. After the pin aimed at the port, press the thermostat hard.
7. It is precision electronic products. Don't knock or fall it.
8. Don't let the water, mud into the thermostat.

11. SPECIFICATIONS

Specifications

the display range of temperature.....	44°F to 90°F (7°C to 32°C)
the control range of temperature.....	44°F to 90°F (7°C to 32°C)
Load rating.....	1 amp per terminal, 1.5 amp maximum all terminals combined
Display accuracy	± 0.5°C
Power source.....	18 to 30 VAC, NEC Class II, 50/60 Hz for hardwire (common wire) Battery power from 2 AA Alkaline batteries
Operating ambient.....	41°F to +95°F(5°C to +35°C)
Operating humidity.....	90% non-condensing maximum
Dimensions of thermostat.....	118mm * 88mm * 30mm

OMEGA
ENVIRONMENTAL
TECHNOLOGIES LLC.

17702 Mitchell North, #101
Irvine, CA. 92614, USA
Tel: 714 795 2830
Fax: 714 966 1646
info@otecomega.com
www.otecomega.com

CETO[®]
CONTROLS CO.

Showroom & Technology Center
11380 Interchange Circle North
Miramar, Florida, 33025 USA
Tel: 888 840 7550, 954 715 5006
Fax: 954 212 8280
info@ceto-controls.com
www.ceto-controls.com

INSTALLATION MANUAL

CETO[®]

CX024-DP2 Programmable Thermostat

Table of Contents	Page
Preface	1
Production Function Overview	1
Diagram and Description	2~3
Wall locations	4
Subbase Installation	5
WIRING	6
Wiring Diagrams	7
Operation	8~10
Mount Thermostat & Battery Installation	11
Caution	12
Specifications	12

1. Preface

Dear client,
Thanks for choosing CX024-DP2 thermostat series. It's our best wish to bring you convenience for your daily life. Before using, please read the User's Manual carefully. It will help you to use it correctly.

2. Production Function Overview

2.1 Application

Description	
Single Stage Heat and Cool	Yes
Multistage Heat and Cool	Yes
Heat Pump without Backup Heat	Yes
Heat Pump with Backup Heat	Yes
Heat Only Systems	Yes
Heat Only Systems-Floor or Wall Furnaces	Yes
Cool Only Systems	Yes
Gas or Oil Heat	Yes
Electric Furnace	Yes
Millivolt	Yes

2.2 Feature

- Programmable thermostat
- 5+2 Programmable
- Easy to program
- 6.8 square inch display
- Battery power or 24V Hardwire
- Single Stage Heat and Cool
- Multistage Heat and Cool
- Heat Pump without Backup Heat
- Heat Pump with Backup Heat
- No Emergency Heat
- Separate heating and cooling swing(cycle rate) adjustments
- 5 minutes compressor delay protection (selectable on or off)
- Gas, Electric or Oil
- internal temperature sensor or remote sensor
- Optional temperature display of Fahrenheit or Celsius scale.
- Low Battery Indicator
- Display temperature calibration



A trained, experienced technician must install this product.

Carefully read these instructions. You could damage this product or cause a hazardous condition if you fail to follow these instructions.

3. Diagram and Description

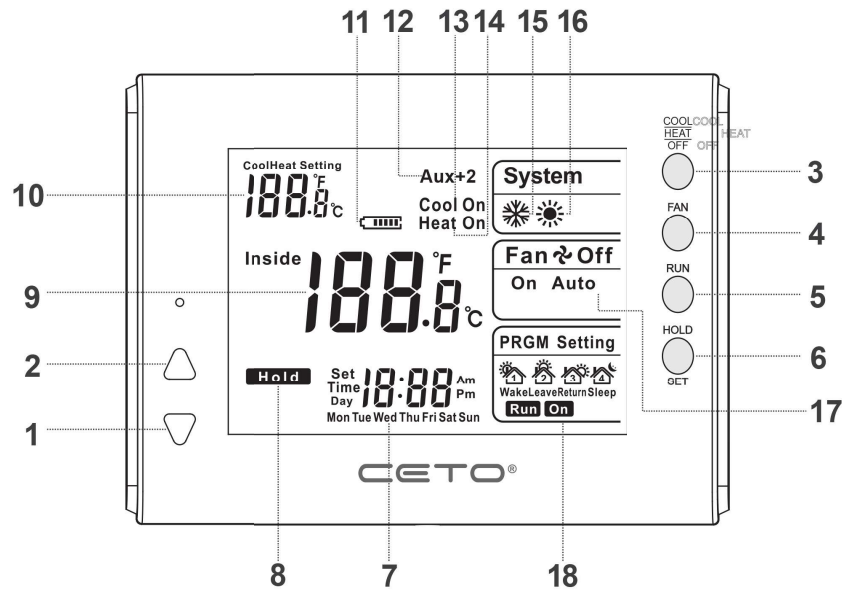

Description

Item	Description
1	Down key: in the cooling/heating mode, it is for lowering the setting temperature. When setting the program and changing the system parameter, it is for adjusting the parameter.
2	Up key: in the cooling/heating mode, it is for raising the setting temperature. When setting the program and changing the system parameter, it is for adjusting the parameter.
3	Mode key: First press for cool mode, and second is for heat mode. Press again will turn off the thermostat.
4	Fan mode: in the cooling/heating mode, switch the fan between on and auto.
5	Run key: Press only once, the thermostat operates according to the time programming. After setting the program and changing the system parameter, press the run key to save and exit the setting interface.

6	Hold/Set key: Press the HOLD only once, the LCD display "hold", and the thermostat keeps the current mode and setting temperature. In the cool/heat mode, press it to keep the setting temperature, and the setting temperature will not change in the setting process. In the cool/heat mode, press and hold the key for 3 seconds to enter the setting interface. When power of, hold the key for 5 seconds to enter the parameter changing interface.
7	Clock/Week: Display the current system time and week.
8	Hold symbol: when the symbol displayed, the setting temperature will be kept and won't follow the setting program.
9	Room temperature: display the current room temperature.
10	Setting temperature: display the setting temperature in the cool/heat mode.
11	Battery symbol: it means low power when the symbol displayed, so please change the battery in time.
12	Aux+2 symbol: it means the thermostat activates auxiliary heating
13	Cool symbol: The cooling relay start to work when the symbol displayed. The symbol flashing means the cooling relay is in the set-up delay process.
14	Heat symbol: The heating relay start to work when the symbol displayed. The symbol flashing means the heating relay is in the set-up delay process.
15	System cool: The symbol displayed means it is in the cooling mode.
16	System heat: The symbol displayed means it is in the heating mode.
17	Fan: display the current mode of the fan.
18	Program setting: it shows the system is in the setting process

4. Wall locations

The thermostat should be installed approximate 4 to 5 feet above the floor. Select an area with average temperature and good air circulation.

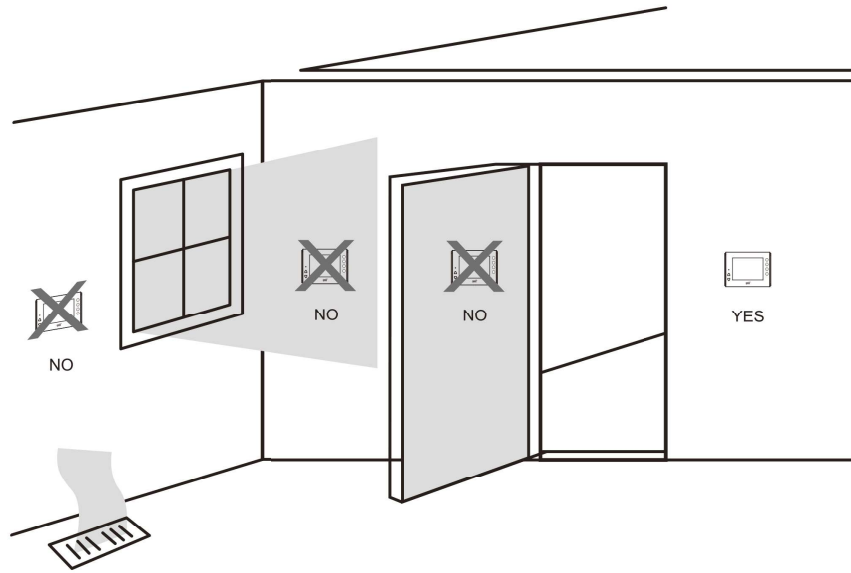

Do not install thermostat at following places:

- Close to hot or cold air ducts
- With direct sunlight
- With an outside wall behind the thermostat
- The areas that do not require conditioning
- Where there are dead spots or drafts (in corners or behind doors)
- Where there might be concealed chimneys or pipes

Installation Tip

Pick an installation location that is easy for the user to access. The temperature of the location should be representative of the building.

5. SUBBASE INSTALLATION



Caution: Electrical Hazard

Failure to disconnect the power before beginning to install this product can cause electrical shock or equipment damage.



Caution: Equipment damage hazard

Do not operate the cooling system if the outdoor temperature is below 50° F (10° C) to prevent possible compressor damage.

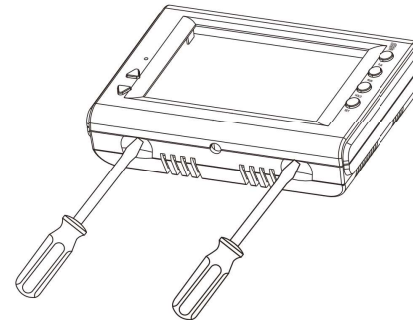

Insert the awl into the slot and pry up the front part of the panel to open it.

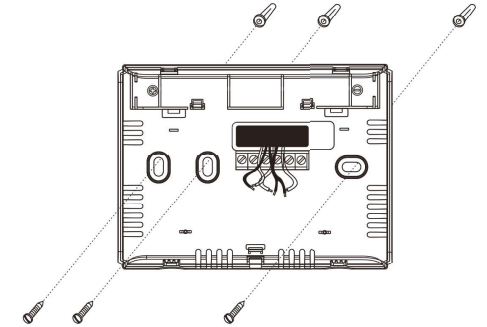

For horizontal mount put one screw left and one screw right.

6. WIRING



Caution: Electrical Hazard

Failure to disconnect the power before beginning to install this product can cause electrical shock or equipment damage.



Warning :

All components of the control system and the thermostat installation must conform to Class II circuits per the NEC Code.

Wiring

1.If you are replacing a thermostat. Take notice of the terminal connections on the cases, the wiring connections may not be color coded. For example, the green wire may not be connected to the G terminal.

2.Loosen the terminal block screws. Insert wires then retighten terminal block screws.

3.Place nonflammable insulation into wall opening to prevent drafts.



Caution:

Do not over tighten terminal block screws, as this can damage terminal block, and keep the thermostat fitting on the sub-base correctly or it will cause system operation issues.

Max Torque = 6in-lbs

Terminal Designation

- C Common wire from secondary side of cooling system transformer
- O Heat pump changeover valve energizes in cooling
- B Heat pump changeover valve energizes in heating
- Y Compressor relay
- W Heat relay

- RC Transformer power for cooling
- RH Transformer power for heating
- G Fan relay
- Aux Back up heat relay
- Y2 2 stage cool relay
- W2 2 stage heat relay

Wiring Tips:

RH & RC terminals

For single transformer systems, leave the jumper wire in place between RH and RC. Remove jumper wire for two transformer systems.

Wire specifications

Use shielded or non-shielded 18 - 22 gauge thermostat wire.

- 1 Power supply
- 2 Factory-installed jumper. Remove only when installing on 2-transformer systems
- 3 In heat pump mode, please check the reversing valve to see whether it is in **O** or **B** position, and enter the system to set reversing valve to the position you need.
- 4 The system is in the electronic mode in default setting. If the system is gas or oil supported, enter the setting interface to set it in the gas mode.
- 5 Optional 24 VAC common connection when thermostat is used on battery power mode
- 6 If users select remote sensor, the users have to find out the correct port and plug the remote sensor in it.

7. WIRING DIAGRAMS

Wiring-conventional system: 1 transformer

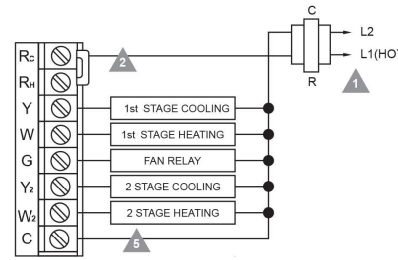

Typical heat pump system

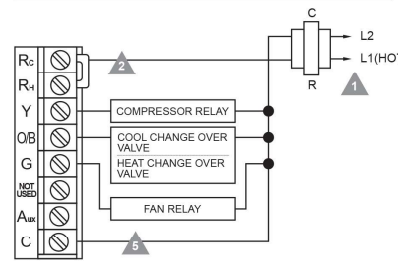

- Tips:**
1. Please set on the heat pump system first.
 2. Please set the valve as heating/cooling system.

Typical heat-only system

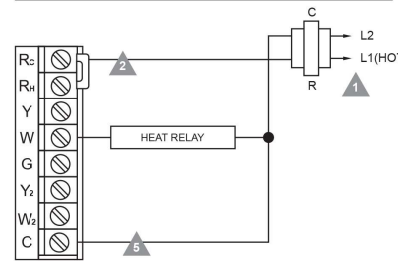

Typical cool-only system

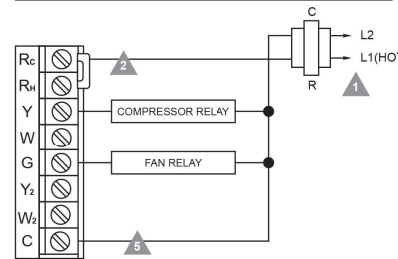

Wiring-conventional system: 2 transformer

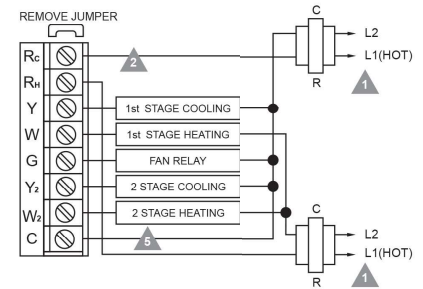

Typical heat pump system with Aux heat

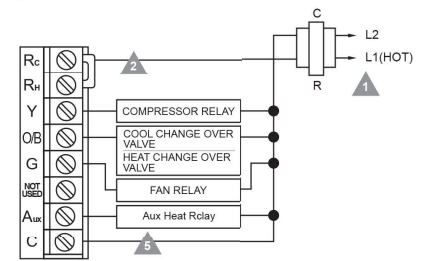

- Tips:**
1. Please set on the heat pump system first.
 2. Please set the valve as heating/cooling system.

Typical heat-only system with fan

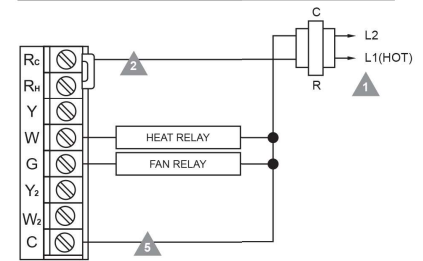

Remote sensor installation

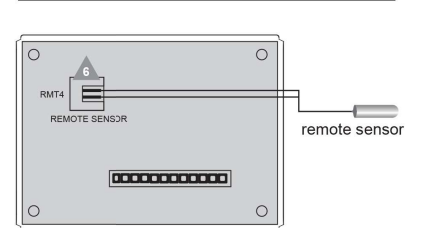

8.Operation

8.1 Operation

(1) COOL/HEAT/OFF: press the " COOL/HEAT/OFF " key once to turn on the system. The mode is cool and " ❄️ " is displayed. Meanwhile the room temperature, setting temperature, clock will be also displayed. Change to the heat mode by the second pressing and " 🔥 " is displayed. Press again to turn off the system and " off " is displayed.

(2) Setting temperature: when power on, press " △ " or " ▽ " to set the temperature. Press " ▽ " to lower the setting temperature, and press " △ " to raise the setting temperature.

(3) Fan mode: When power on, press it to choose the fan on, and press again to change the fan to auto mode.

(4) Run key: When power on, press the key to run the program what has been set. Meanwhile "Run On" is displayed. In the programming mode or changing the system parameter, press "RUN" to exit and save the changed parameter.

(5) Hold key: When power on, press the "Hold" key to keep the setting temperature. It won't run the program and display "Hold". For example: now the setting temperature is 60°F ,after pressing the "HOLD" the system will lock the setting temperature to be 60°F .

8.2 Programming setting

When power on(in cool/heat mode),hold " SET " for 3 seconds to enter the programming mode:

(1) First is to set the system clock. When the clock area is flashing, press " △ " or " ▽ " to change the clock. And if you hold " △ " or " ▽ " , the adjustment will be faster.

(2) Press " SET " again to set the week. When the week flashing, press " △ " or " ▽ " to change the week.

(3) Press " SET " again to set the Wake time from Monday to Friday. When the clock area is flashing, press " △ " or " ▽ " to adjust the time.

(4) Press " SET " again to set the Wake temperature from Monday to Friday. When the clock area is flashing, press " △ " or " ▽ " to adjust the temperature.

(5) Repeat pressing the " SET ", then you can set the time and temperature of Leave, Return, Sleep, from Monday to Friday and Saturday, Sunday by turn.

(6) After finished the setting, press the " RUN " to cancel the setting interface and save the parameter. (if there's no any operation within 30 seconds when setting, the system will exit the setting interface and abandon the changed parameter.)

EXAMPLE:

Heating/Cooling Schedule Plan(Factory default program setting)

		Weekdays (5 day)		Saturday and Sunday	
Mode	Period	Start Time	Temperature	Start Time	Temperature
Heat	Wake	6:00 AM	21°C	6:00 AM	21°C
	Leave	8:00 AM	17°C	8:00 AM	17°C
	Return	6:00 PM	21°C	6:00 PM	21°C
	Sleep	10:00 PM	17°C	10:00 PM	17°C
Cool	Wake	6:00 AM	24°C	6:00 AM	24°C
	Leave	8:00 AM	28°C	8:00 AM	28°C
	Return	6:00 PM	24°C	6:00 PM	24°C
	Sleep	10:00 PM	26°C	10:00 PM	26°C

8.3 System parameter setting

When power off, hold " SET " key for 5 seconds to enter the parameter changing interface. Room temperature area displays each symbol of the parameter, and system clock area displays each parameter of the parameter values. Repeat to press " SET " key to cycling display the each parameter. Press " △ " or " ▽ " to adjust each parameter. After finished changing, press " RUN "key to exit the setting interface and save the set parameter.(if there's no any operation within 30 seconds when setting, the system will exit the setting interface and abandon the changed parameter.)

Step	Press Buttons	Display(Factory Defaults)	Press△or▽to select	Default parameters	Description
01	SET5 seconds	CC	FA or SL	FA	Select fast cooling or slow cooling
02	SET	HC	FA or SL	FA	Select fast heating or slow heating
03	SET	FC	F or C	C	Select °F or °C Readout
04	SET	CP	0 or 5	0	Compressor Lockout delay time 0 = none ; 5 = Minutes
05	SET	CA	-5° to +5°	0	room temperature error correction
06	SET	HP	1 or 0	0	conventional heat pump selection 0: conventional mode 1: heat pump mode
07	SET	Ob	0 or b	0	Select cool/heat change over valve "b" = heat change over valve "0" =cool change over valve
08	SET	IC	1 or 0	0	Intelligent Recovery Option "1" = Active "0" =Deactivated
09	SET	6E	E or 6	E	"E"=Electric "6"=Gas
10	RUN	RETURNS TO NORMAL OPERATION			

01. Select cooling cycle rate

The **FA** setting is used to produce shorter cooling cycles. The **SL** setting produces a longer cooling cycle. Both settings produce very accurate temperature control and can be set to your personal preference.

02. Select heating cycle rate

The **FA** setting is used to produce shorter heating cycles. The **SL** setting produces a longer a longer heating cycle. Both setting produce very accurate temperature control and can be to your personal preference.

03. Select °F or °C readout

Changes the display readout to Centigrade or Fahrenheit as required. The default setting is "°F".

04. Select compressor lockout delay

To protect the compressor from short cycling, you can select compressor off-time cycle between **0** or **5** minutes. When the thermostat compressor time delay occurs, the **Cool On** or **Heat On** display will flash during compressor lockout. The default setting is "0".

05. Select temperature recalibration

This feature allows you to adjust the displayed room temperature up to 5° higher or lower. Your thermostat can be accurately calibrated to match your previous thermostat. The current or adjusted room temperature will be displayed on the display. The default setting is "0".

06. Choose traditional mode or heat pump mode

Users can choose traditional mode or heat pump mode according to your own conditon. When heat pump mode set, the compressor will be enforced 5minutes delay to restart.

07. Choose the reversing valve of the heat pump

Users can choose the reversing valve working on the heat mode or the cool mode. In heat pump mode, please check the reversing valve to see whether it is in O or B position, and enter the system to set reversing valve to the position you need.

08. Intelligent Recovery Option

The thermostat has an intelligent recovery function that brings your room temperature at exactly the pre-set time by turning on the Heating earlier. Select **1** to activate the intelligent recovery function, Select **0** to deactivate the intelligent recovery function. The default setting is "0".

09. Heat fan control

This function is the control and choosing for the heat fan. If the user uses the Gas or Oil heating system, please choose "**Gas**"(system controls fan operation).If the user uses the Electric heating system, please choose "**Electric**"(thermostat controls fan operation).

10. Aux Heat or cool offset

Users can select aux heating or cooling offset 1°to 9°according to personal requirements. If you select 2°, When room temperature is 2°higher than setting temperature in Cooling or 2° lower than setting temperature in Heating ,the thermostat will activates auxiliary cooling mode or heating mode. When room temperature is 0-2°higher than setting temperature in Cooling or 0-2° lower than setting temperature in Heating ,the thermostat is in the 1st stage cooling or heating mode.

11. internal sensor or remote sensor

Users can select a sensor between internal sensor and remote sensor.If you select 0,the system will collect the room temperature by the internal sensor. If you select 1,the system will collect the room temperature by the remote sensor,meanwhile the equipped remote sensor must be plugged into the corresponding port on the thermostat.

9.MOUNT THERMOSTAT & BATTERY INSTALLATION

12. Indoor fan delay time

In heat pump mode, if fan mode is "on", the fan start directly, when heat mode start. If fan mode is "auto", users can select 0-60 seconds time for fan delay. Which will Give some time for IDU coil warm up.

8.4 Restore factory settings

When power off, hold " FAN " key for 8 seconds. Symbol " dEF " displayed in the clock area shows restoring factory setting is successful, and press " RUN " key to exit.

9.MOUNT THERMOSTAT & BATTERY INSTALLATION

Battery Installation

Important :

High quality alkaline batteries are recommended. Rechargeable batteries or low quality batteries do not guarantee 1-year life span.

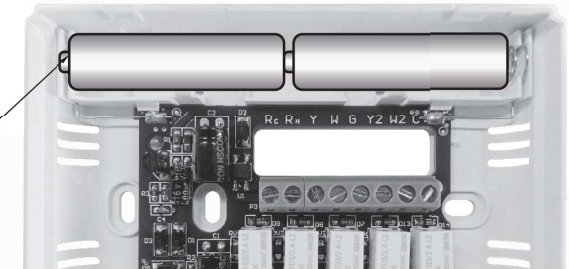

Insert 2 AA Alkaline batteries(not included). High quality alkaline batteries are recommended.

Mount Thermostat

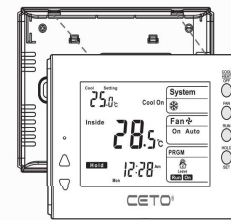

Step 1: Aim at the inner snaps in the higher part of the thermostat.

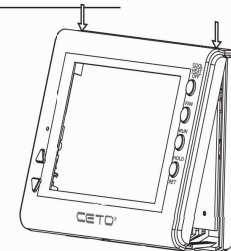

Step 2: Hang the two hooks of the front part at 30° right to the snaps.

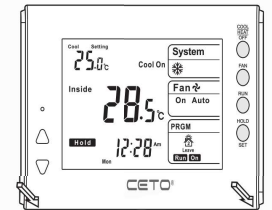

Step 3: Press the lower part of the front display panel to complete the installation.



In Step 3, if the user think it is hard to connect the pin, please move the display panel slightly. Then it will be work.