

# BCHB-D Ultima Series

## Mini VRF Outdoor Unit Service Manual

**208~230V/1/50-60Hz**



---

# CONTENTS

**Part 1 General Information.....3**

**Part 2 Component Layout and Refrigerant Circuits .....7**

**Part 3 Control ..... 15**

**Part 4 Field Settings..... 23**

**Part 5 Electrical Components and Wiring Diagrams ..... 32**

**Part 6 Diagnosis and Troubleshooting..... 45**

---

# Part 1

## General Information

<b>1 Indoor and Outdoor Unit Capacities.....</b>	<b>4</b>
<b>2 External Appearance.....</b>	<b>5</b>
<b>3 Combination Ratio.....</b>	<b>6</b>

# 1 Indoor and Outdoor Unit Capacities

## 1.1 Indoor Units

Table 1-1.1: Indoor unit abbreviation codes

Abbreviation code	Type
BECW	One-way Cassette
BECM	Compact Four-way Cassette
BECS	Four-way Cassette
BEMP	Medium Static Pressure Duct
BEHP	High Static Pressure Duct
BEWM	Wall-mounted

Table 1-1.2: Indoor unit capacity range

Capacity			Capacity index	BECW	BECM	BECS	BEHP	BEMP	BEWM
kBtu/h	kW	HP							
5	1.5	0.5	5	—	5	—	—	—	—
6	1.8	0.6	6	6	—	—	—	—	—
7	2.2	0.8	7	7	7	—	—	7	7
9	2.8	1	9	9	9	9	—	9	9
12	3.6	1.25	12	12	12	12	—	12	12
15	4.5	1.6	15	15	15	15	—	15	15
18	5.6	2	18	18	—	18	—	18	18
24	7.1	2.5	24	24	—	24	24	24	24
28	8.0	3	28	—	—	28	28	28	28
32	9.0	3.2	32	—	—	32	32	32	32
36	10.0	3.6	36	—	—	36	—	—	—
40	11.2	4	40	—	—	40	40	40	—
48	14.0	5	48	—	—	48	48	48	—
56	16.0	6	56	—	—	56(DC)	56	56	—

Notes:

1. Atom series indoor units could connect to Atom series outdoor units.

## 1.2 Outdoor Units

Table 1-1.3: Outdoor unit capacity range

Capacity (kBtu/h)	Model Name
12	BCHB015Q0A3-DTM040
18	BCHB020Q0A3-DTM060
21	BCHB025Q0A3-DTM070
28	BCHB030Q0A4-DTM090
36	BCHB040Q0A6-DTM115
42	BCHB050Q0A7-DTM140
48	BCHB060Q0A8-DTM160
56	BCHB070Q0A9-DTM190
60	BCHB080Q0A9-DTM200

Notes:







1. Atom series outdoor units could not be combined.



## 2 External Appearance





### 2.1 Indoor Units

Table 1-2.1: Indoor unit appearance

<p>One-way Cassette BECS</p> 	<p>Four-way Cassette BECS</p> 
<p>Compact Four-way Cassette BECM</p> 	<p>Wall-mounted BEWM</p> 
<p>High Static Pressure Duct BEHP</p> 	<p>Medium Static Pressure Duct BEMP</p> 

### 2.2 Outdoor Units

Table 1-2.2: Outdoor unit appearance

<p>12/18/21kBTu/h</p>	<p>28/36kBTu/h</p>
	
<p>42/48/56kBTu/h</p>	<p>60kBTu/h</p>
	

## 4 Combination Ratio

$$\text{Combination ratio} = \frac{\text{Sum of capacity indexes of the indoor units}}{\text{Capacity index of the outdoor unit}}$$

Table 1-4.1: Indoor and outdoor unit combination ratio limitations

Type	Minimum combination ratio	Maximum combination ratio
Atom Series outdoor units	45%	130%

Table 1-4.2: Combinations of Indoor and outdoor units

Outdoor unit capacity		Sum of capacity indexes of connected indoor units (standard indoor units only)	Number of connected indoor units
kBtu/h	Capacity index		
12	12	5.4 to 15.6	1-3
18	18	8.1 to 23.4	1-3
21	21	9.5 to 27.3	1-3
28	28	12.6 to 36.4	1-4
36	36	16.2 to 46.8	1-6
42	42	18.9 to 54.6	1-7
48	48	21.6 to 62.4	1-8
56	56	25.2 to 72.8	1-9
60	60	27.0 to 78	1-9

# Part 2

# Component Layout and Refrigerant Circuits

1 Piping Diagrams ..... 8

2 Refrigerant Flow Diagrams ..... 11

# 1 Piping Diagrams

Figure 2-1.1: BCHB030Q0A4-DTM090 model piping diagram

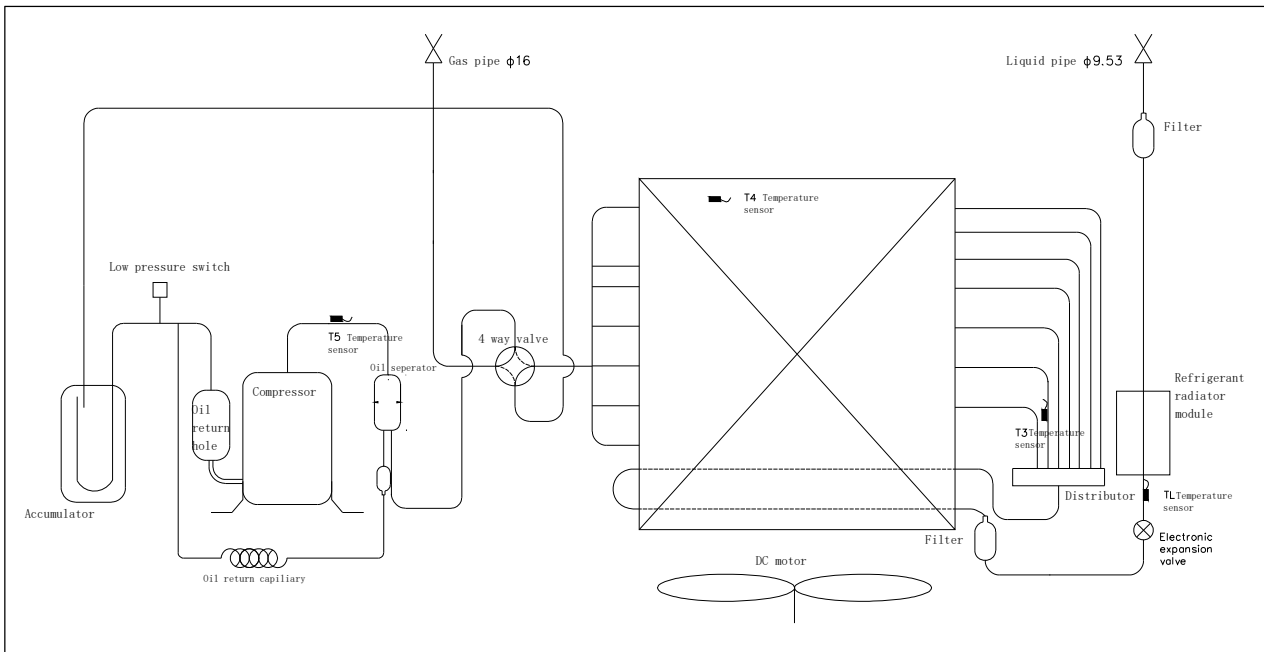

Figure 2-1.2: BCHB040Q0A6-DTM115 model piping diagram

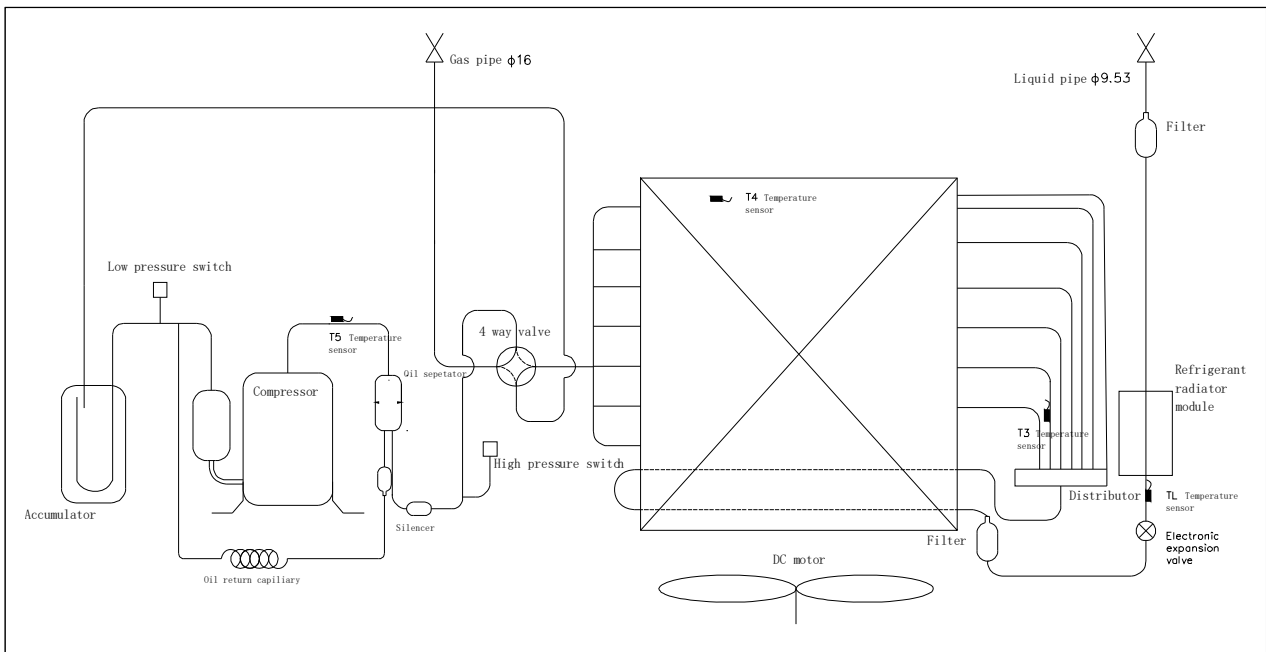

Figure 2-1.3: BCHB050Q0A7-DTM140 model piping diagram

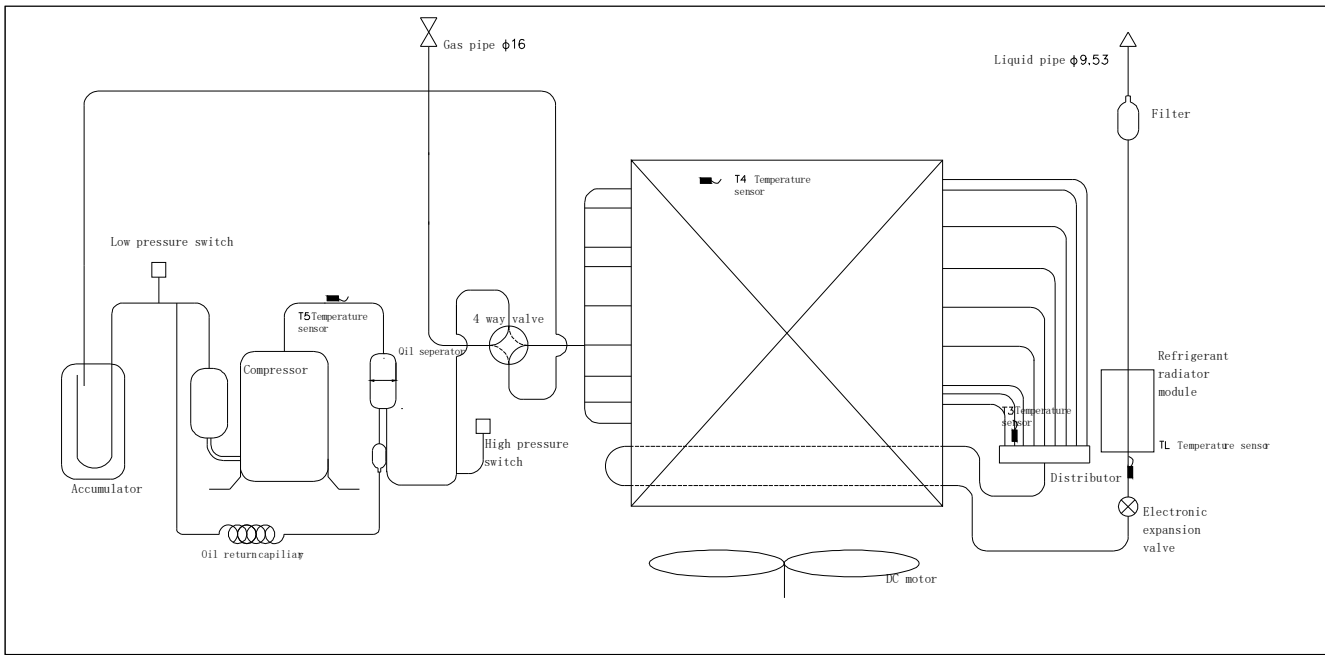

Figure 2-1.3: BCHB060(70)Q0A8-DTM160(190) model piping diagram

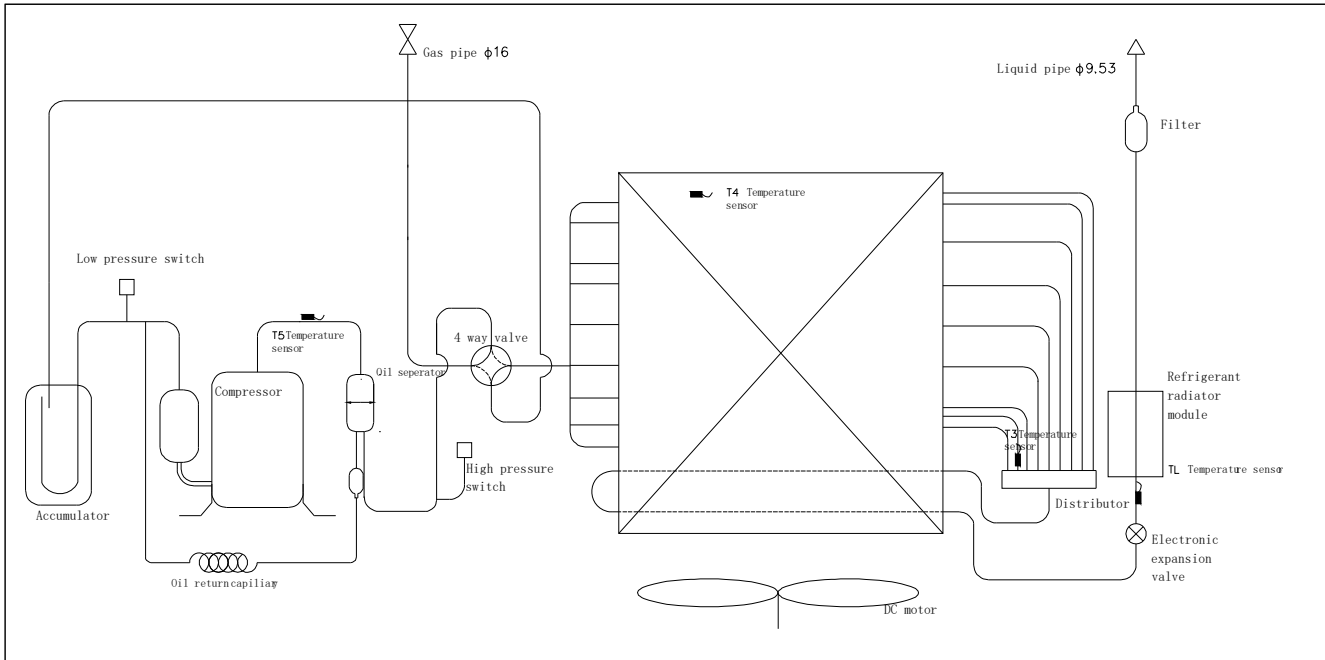
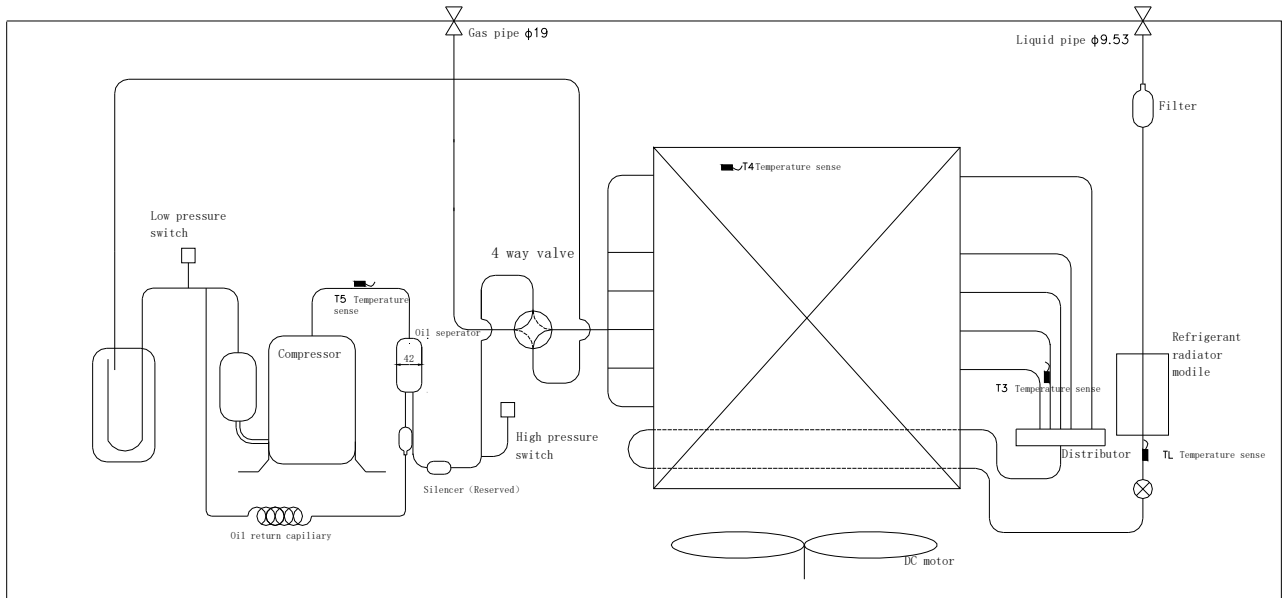

Figure 2-1.3: BCHB080Q0A9-DTM200 model piping diagram



**Key components:**

1. **Oil separator:**  
Separates oil from gas refrigerant pumped out of the compressor and quickly returns it to the compressor. Separation efficiency is up to 99%.
2. **Gas-liquid separator:**  
Stores liquid refrigerant and oil to protect compressor from liquid hammering.
3. **Electronic expansion valve (EXV):**  
Controls refrigerant flow and reduces refrigerant pressure.
4. **Four-way valve(ST1):**  
Controls refrigerant flow direction. Closed in cooling mode and open in heating mode. When closed, the heat exchanger functions as a condenser; when open, the heat exchanger functions as an evaporator.
5. **High and low pressure switches:**  
Regulate system pressure. When system pressure rises above the upper limit or falls below the lower limit, the high or low pressure switches turn off, stopping the compressor. After 5 minutes, the compressor restarts.

## 2 Refrigerant Flow Diagrams

### Cooling operation

Figure 2-2.1: BCHB030(40,50,60,70,80)Q0A4-DTM090(115,140,160,190,200) models refrigerant flow during cooling operation

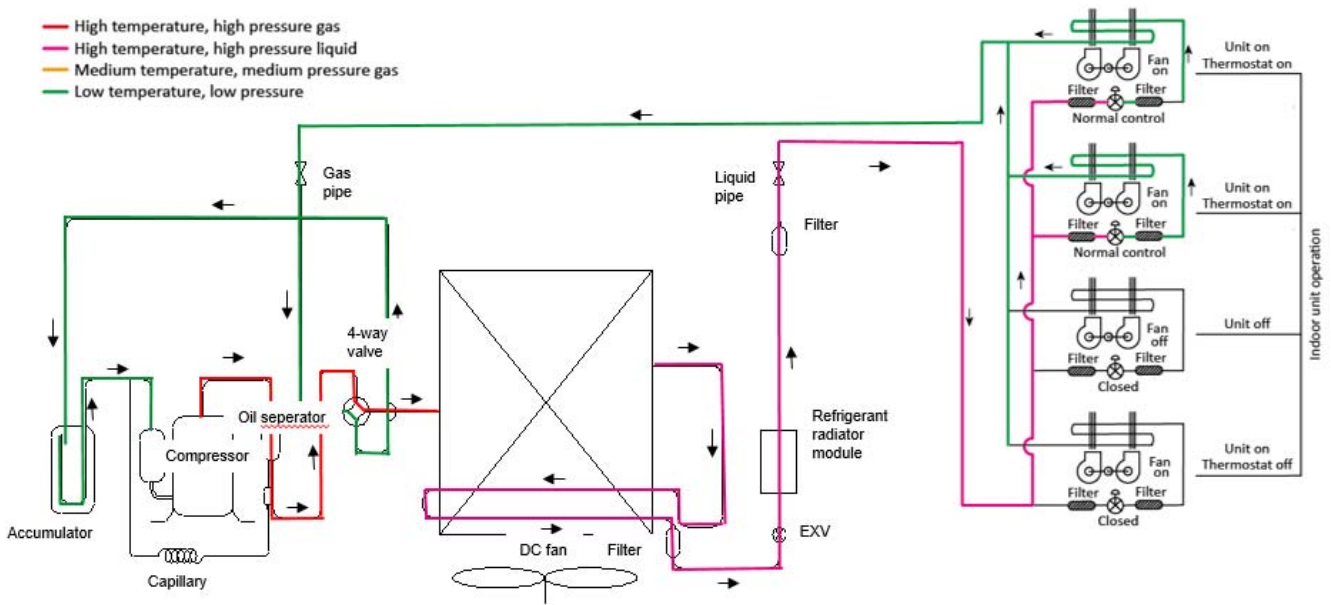

### Oil return operation in cooling mode

Figure 2-2.4: BCHB030(40,50,60,70,80)Q0A4-DTM090(115,140,160,190,200) models refrigerant flow during oil return operation in cooling mode

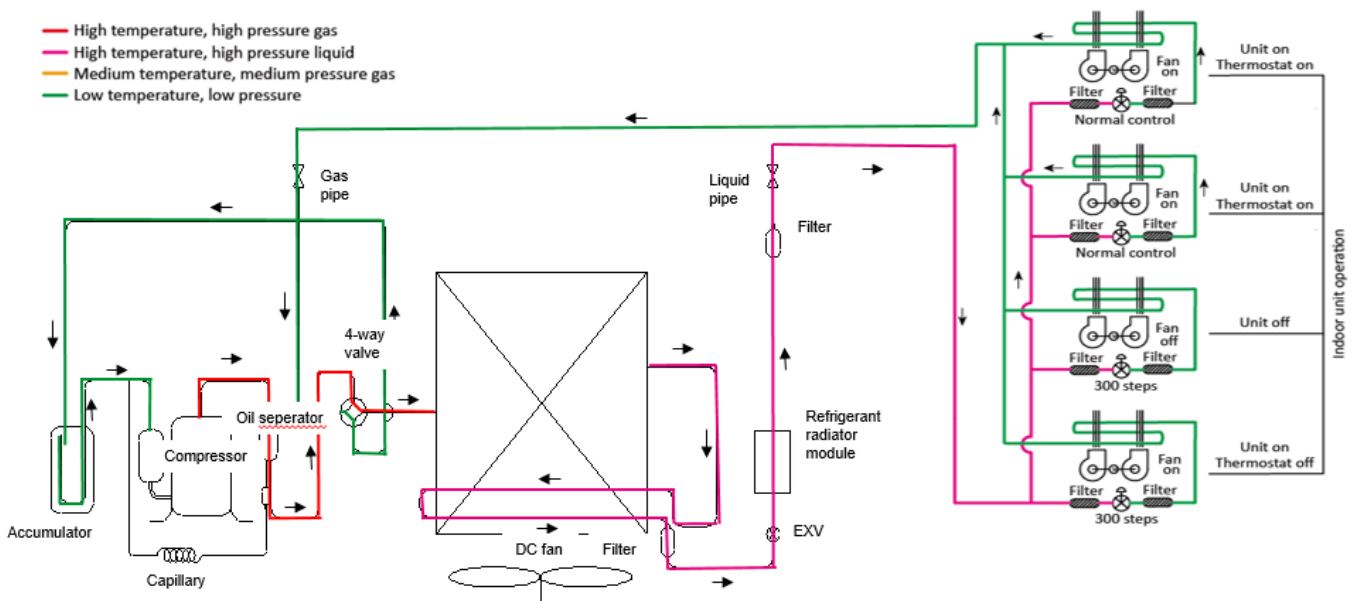

## Heating operation

Figure 2-2.7: BCHB030(40,50,60,70,80)Q0A4-DTM090(115,140,160,190,200) models refrigerant flow during heating operation

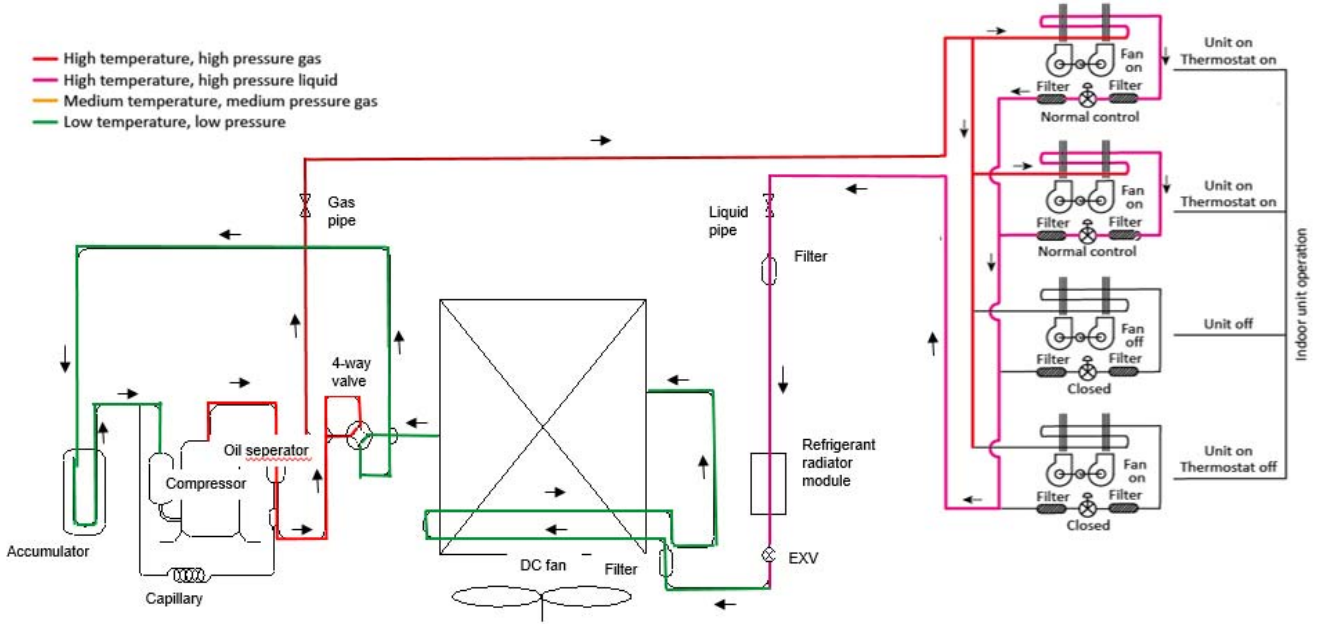

## Oil return operation in heating mode

Figure 2-2.10: BCHB030(40,50,60,70,80)Q0A4-DTM090(115,140,160,190,200)models refrigerant flow during oil return operation in heating mode

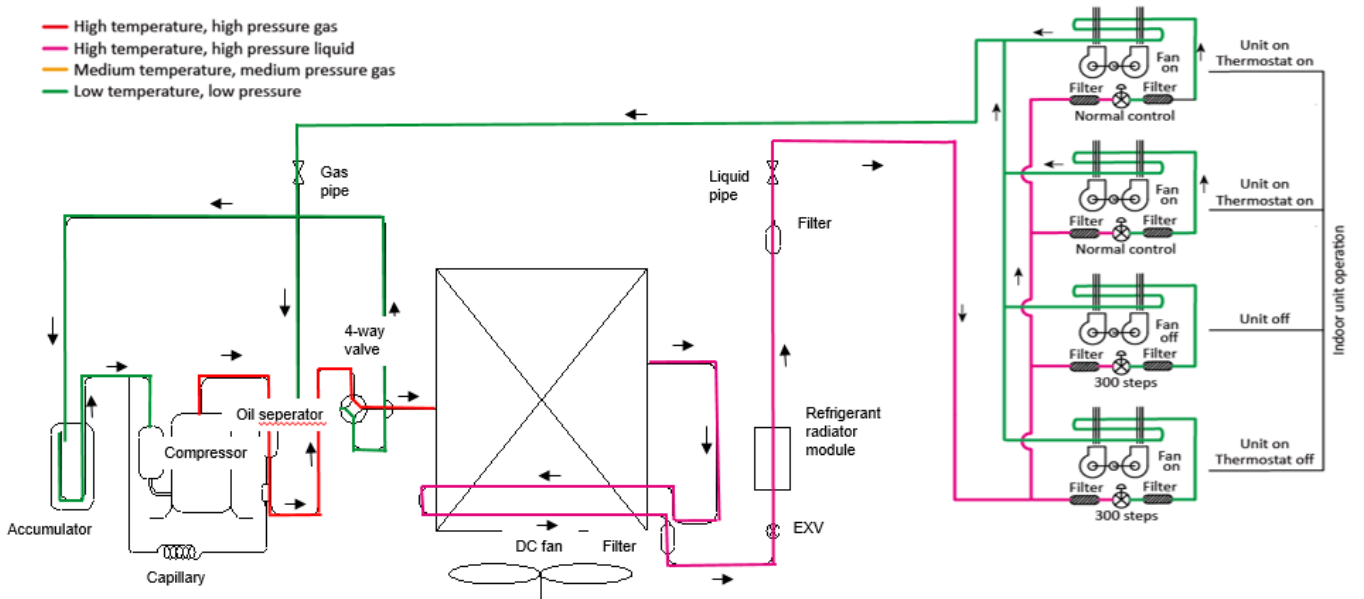



### Defrosting operation

Figure 2-2.13: BCHB030(40,50,60,70,80)Q0A4-DTM090(115,140,160,190,200) models refrigerant flow during defrosting operation

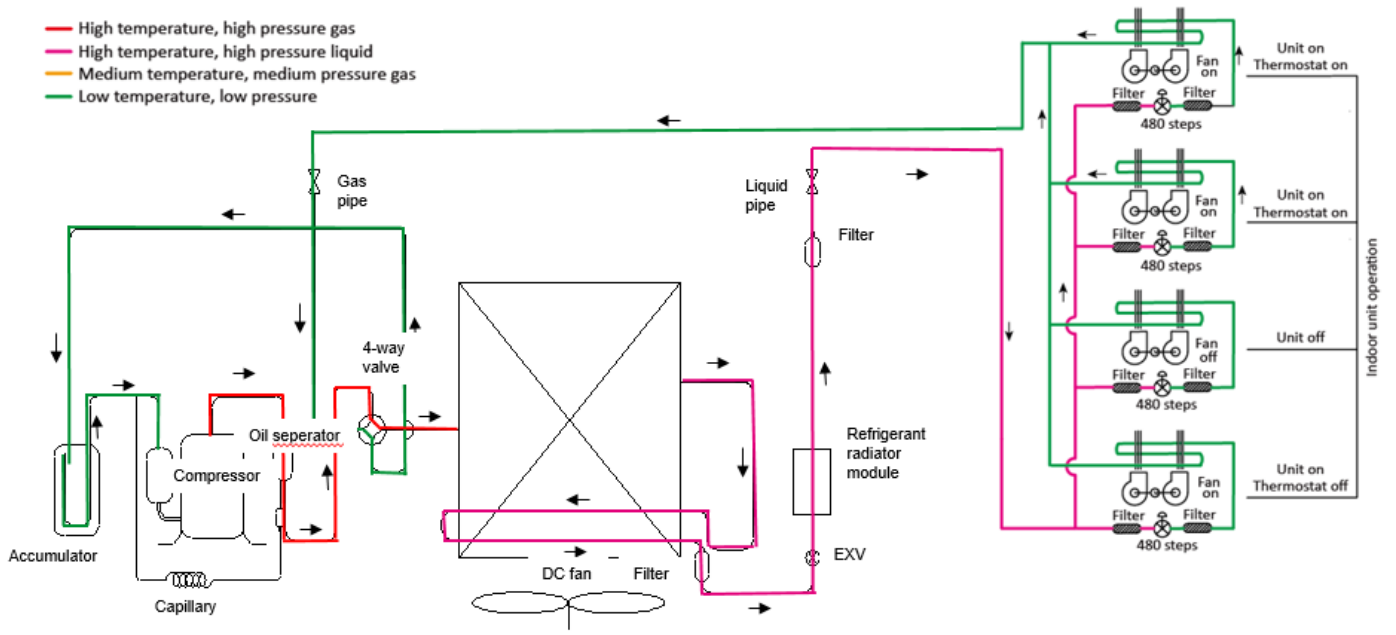

# Part 3

# Control

<b>1 General Control Scheme Flowchart .....</b>	<b>16</b>
<b>2 Stop Operation .....</b>	<b>17</b>
<b>3 Startup Control .....</b>	<b>17</b>
<b>4 Normal Operation Control .....</b>	<b>18</b>
<b>5 Protection Control .....</b>	<b>19</b>
<b>6 Special Control.....</b>	<b>21</b>

# 1 General Control Scheme Flowchart

Sections 3-2 to 3-7 on the following pages detail when each of the controls in the flowchart below is activated.

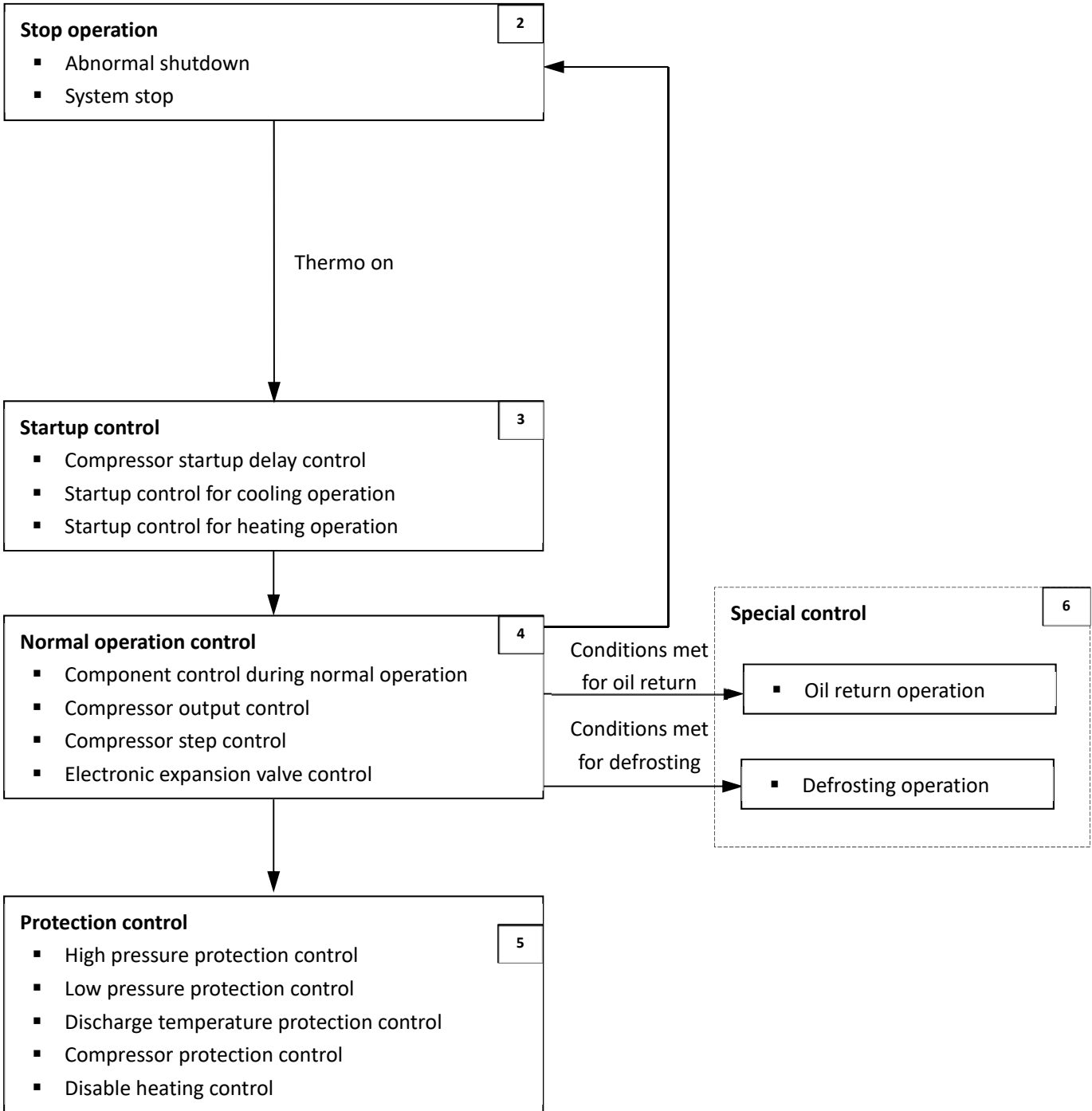

**Legend**

Numbers in the top right-hand corners of boxes indicate the relevant section of text on the following pages.

## 2 Stop Operation

The stop operation occurs for one of the two following reasons:

1. Abnormal shutdown: in order to protect the compressors, if an abnormal state occurs the system makes a 'stop with thermo off' operation and an error code is displayed on the outdoor unit digital displays.
2. The system stops when the set temperature has been reached.

## 3 Startup Control

### 3.1 Compressor Startup Delay Control

When the ODU is powered on again and the compressor delays about 7 minutes to start. After the compressor stops running, it takes about 4 minutes to restart, in order to prevent frequent compressor on/off and to equalize the pressure within the refrigerant system.

### 3.2 Startup Control for Cooling Operation

Table 3-3.1: Component control during startup in cooling mode

Component	Wiring diagram label	28-60 model	Control functions and states
Inverter compressor	COMP	•	Controlled according to load requirement, operating frequency increased by 1 step / sec
DC fan motor	FAN	•	The outdoor unit fan start by 14 gears for 20 seconds before compressor start, and then maintain the fan speed for another 20 seconds when compressor start, finally the fan speed controlled according to heat exchanger temperature (T3), outdoor ambient temperature (T4), discharge temperature (T5) and compressor frequency.
Electronic expansion valve	EEV	•	Maintain 304(step) for 3 minutes before compressor startup, then controlled according to discharge temperature
Four-way valve	ST1	•	Off

### 3.3 Startup Control for Heating Operation

Table 3-3.2: Component control during startup in heating mode

Component	Wiring diagram label	28-60 model	Control functions and states
Inverter compressor	COMP	•	Controlled according to load requirement, operating frequency increased by 1 step / sec
DC fan motor	FAN	•	The outdoor unit fan start by 14 gears for 20 seconds before compressor startup, and then maintain the fan speed for another 20 seconds when compressor start, finally the fan speed controlled according to heat exchanger temperature (T3), outdoor ambient temperature (T4) and compressor frequency.
Electronic expansion valve	EEV	•	Maintain 304 step(model 28/42) or 480 step(model 36/48/56/60) for 3 minutes before compressor startup, then controlled according to discharge temperature
Four-way valve	ST1	•	On

## 4 Normal Operation Control

### 4.1 Component Control during Normal Operation

Table 3-4.1: Component control during normal cooling operation

Component	Wiring diagram label	28-60 model	Control functions and states
Inverter compressor	COMP	•	Controlled according to load requirement
DC fan motor	FAN	•	Fan speed controlled according to heat exchanger temperature (T3), outdoor ambient temperature (T4), discharge temperature (T5) and compressor frequency.
Electronic expansion valve	EEV	•	Controlled according to discharge temperature
Four-way valve	ST1	•	Off

Table 3-4.2: Component control during heating operation

Component	Wiring diagram label	28-60 model	Control functions and states
Inverter compressor	COMP	•	Controlled according to load requirement
DC fan motor	FAN	•	Fan speed controlled according to outdoor unit heat exchanger refrigerant temperature (T3), outdoor ambient temperature (T4) and compressor frequency.
Electronic expansion valve	EEV	•	Controlled according to discharge temperature
Four-way valve	ST1	•	On

### 4.2 Compressor Output Control

The compressor rotation speed is controlled according to the load requirement. Before compressor startup, the outdoor unit first estimates the indoor unit load requirement according to the nominal capacity of indoor units currently running, and then correct for ambient temperature. The compressors then start up according to the corrected load requirement.

During operation the compressors are controlled according to the nominal capacity of indoor units currently running and the indoor unit heat exchanger temperatures.

### 4.3 Compressor Step Control

The running speed of the compressors in rotations per second (rps) is one third of the frequency (in Hz) of the electrical input to the compressor motors. The compressor speed can be altered in increments of 1 rps.

### 4.4 Electronic Expansion Valve Control

The position of electronic expansion valves EXV is controlled in steps from 0 (fully closed) to 480 (fully open).

In cooling mode:

- When the outdoor unit is in standby:
  - EXV is at position 304 (steps)(model 28/42) or 480(steps)(model 36/48/56/60).
- When the outdoor unit is running:
  - EXV is controlled according to discharge temperature (After 3 minutes in standby mode).

In heating mode:

- When the outdoor unit is in standby:
  - EXV is at position 304 (steps)(model 28/42) or 480(steps)(model 36/48/56/60).
- When the outdoor unit is running:
  - EXV is controlled according to discharge temperature (After 3 minutes in standby mode).

## 5 Protection Control

### 5.1 High Pressure Protection Control (exclude model 28)

This control protects the system from abnormally high pressure and protects the compressors from transient spikes in pressure.

Figure 3-5.1: High pressure protection control

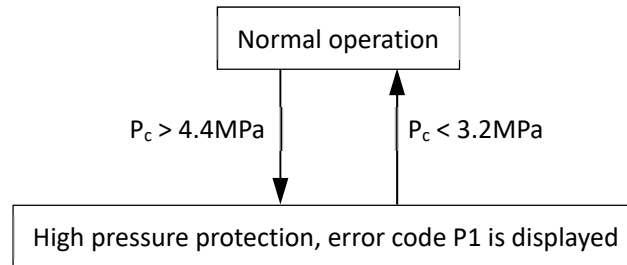

Notes:

1.  $P_c$ : Discharge pressure

When the discharge pressure rises above 4.4MPa the system displays P1 protection and the unit stops running. When the discharge pressure drops below 3.2MPa, the compressor enters re-start control.

### 5.2 Low Pressure Protection Control

This control protects the system from abnormally low pressure and protects the compressors from transient drops in pressure.

Figure 3-5.2: Low pressure protection control

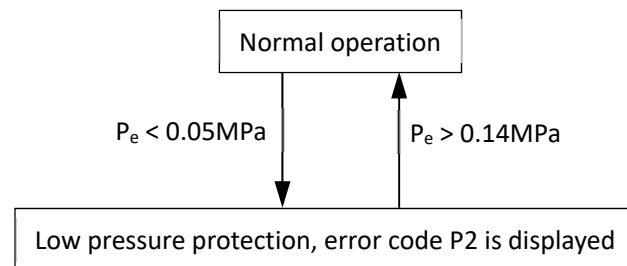

Notes:

1.  $P_e$ : Suction pressure

When suction pipe pressure drops below 0.05MPa the system displays P2 protection and the unit stops running. When the suction pipe pressure rises above 0.14MPa, the compressor enters re-start control.

### 5.3 Discharge Temperature Protection Control

This control protects the compressors from abnormally high temperatures and transient spikes in temperature. It is performed for each compressor.

Figure 3-5.3: High discharge temperature protection control

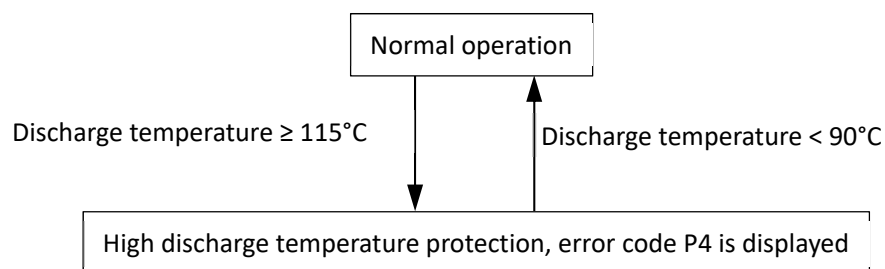

When the discharge temperature rises above or equal to 115°C the system displays P4 protection and the unit stops running. When the discharge temperature drops below 90°C, the compressor enters re-start control.

## 5.4 Compressor and Inverter Module Protection Control

This control protects the compressors from abnormally high currents and protects the inverter modules from abnormally high temperatures.

Figure 3-5.4: Compressor current protection control

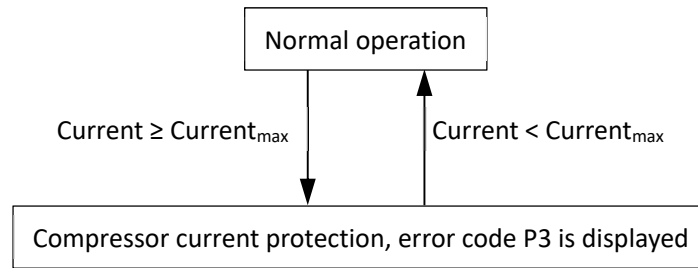

## 5.5 Disable Cooling Control

When the outdoor ambient temperature drops below or equal to  $-15^{\circ}\text{C}$ , cooling mode is disabled to prevent low compression ratios which can result in insufficient compressor internal oil lubrication, and prevent humid compressed in low superheat of compressor bottom conditions. When the outdoor ambient temperature rises above or equal to  $-14^{\circ}\text{C}$ , the compressor enters re-start control.

Figure 3-5.6: Disable heating control

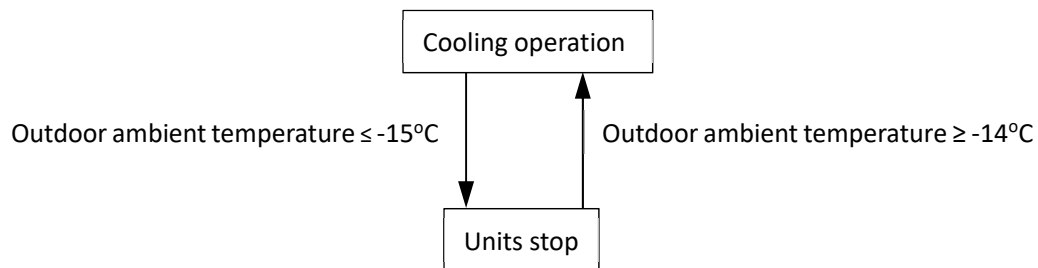

## 6 Special Control

### 6.1 Oil Return Operation

In order to prevent compressors from running out of oil, the oil return operation is conducted to recover oil that has flowed out of the compressor(s) and into the piping system. This operation is performed for all units including units that are in standby.

Timing of oil return operation:

- When the initial cumulative operating time reaches every 8 hours.

Tables 3-6.1 and 3-6.2 show component control during oil return operation in cooling mode.

*Table 3-6.1: Outdoor unit component control during oil return operation in cooling mode*

Component	Wiring diagram label	28-60 model	Control functions and states
Inverter compressor	COMP	●	Fixed frequency
DC fan motor	FAN	●	Normal control as cooling operation
Electronic expansion valve	EEV1	●	Position 300 (steps)
Four-way valve	ST1	●	Off

*Table 3-6.2: Indoor unit component control during oil return operation in cooling mode*

Component	Unit state	Control functions and states
Fan	Thermo on	Remote controller setting
	Standby	Remote controller setting
	Thermo off	Off
Electronic expansion valve	Thermo on	Normal control
	Standby	300 (steps)
	Thermo off	300 (steps)

Tables 3-6.3 and 3-6.4 show component control during oil return operation in heating mode.

*Table 3-6.3: Outdoor unit component control during oil return operation in heating mode*

Component	Wiring diagram label	28-60 model	Control functions and states
Inverter compressor	COMP	●	Fixed frequency
DC fan motor	FAN	●	Fan speed controlled according to heat exchanger temperature (T3) and outdoor ambient temperature (T4)
Electronic expansion valve	EEV1	●	Position 300 (steps)
Four-way valve	ST1	●	Off

*Table 3-6.4: Indoor unit component control during oil return operation in heating mode*

Component	Unit state	Control functions and states
Fan	Thermo on	Operate on setting fan speed (Prevent cold wind priority)
	Standby	Operate on setting fan speed (Prevent cold wind priority)
	Thermo off	Off
Electronic expansion valve	Thermo on	Normal control
	Standby	480 (steps)
	Thermo off	480 (steps)

Note: Prevent cold wind: It's only valid in heating operation, and this control is priority to other controls (including heating oil return and defrost), Which determine the conversion between setting fan speed with low fan speed and turn off the fan according to the evaporator coil temperature T2.



## 6.2 Defrosting Operation

In order to recover heating capacity, the defrosting operation is conducted when the outdoor unit heat exchanger is performing as an evaporator. The defrosting operation is controlled according to outdoor ambient temperature, outdoor heat exchanger temperature, indoor heat exchanger temperature and outdoor unit running time. When the outdoor unit is running in defrosting, the digital display on outdoor main PCB will display “df”.

Table 3-6.5: Outdoor unit component control during defrosting operation

Component	Wiring diagram label	28-60 model	Control functions and states
Inverter compressor	COMP	•	Fixed frequency
DC fan motor	FAN	•	Fan speed controlled according to outdoor ambient temperature (T4) before running in defrosting
Electronic expansion valve	EEV1	•	Position 480 (steps)
Four-way valve	ST1	•	Off

Table 3-6.6: Indoor unit component control during defrosting operation

Component	Unit state	Control functions and states
Fan	Thermo on	Operate on setting fan speed (Prevent cold wind priority)
	Standby	Operate on setting fan speed (Prevent cold wind priority)
	Thermo off	Off
Electronic expansion valve	Thermo on	480 (steps)
	Standby	480 (steps)
	Thermo off	480 (steps)

Note: Prevent cold wind: It's only valid in heating operation, and this control is priority to other controls (including heating oil return and defrost), Which determine the conversion between setting fan speed with low fan speed and turn off the fan according to the evaporator coil temperature T2.

---

# Part 4

# Field Settings

<b>1 Outdoor Unit Field Settings .....</b>	<b>24</b>
--	-----------

# 1 Outdoor Unit Field Settings

Figure 4-1.1: BCHB030QA4-DTM090 model outdoor unit main PCB

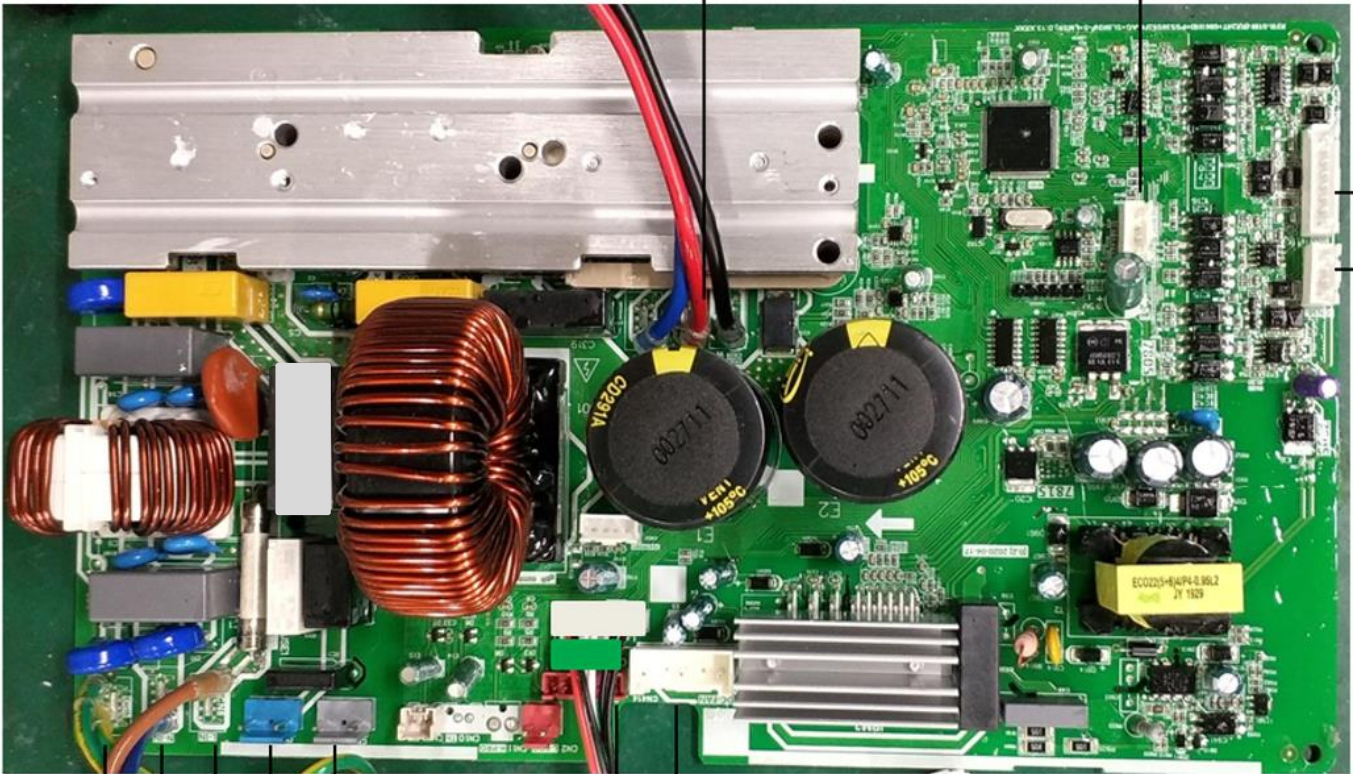

Figure 4-1.2: BCHB030QA4-DTM090 model outdoor unit communication switchboard

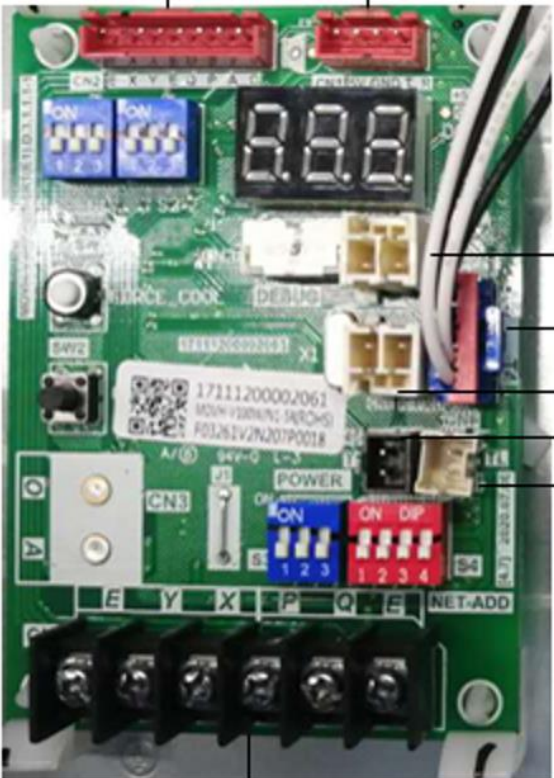





















Table 4-1.1: BCHB030Q0A4-DTM090 model outdoor unit main PCB switch settings

Switch	Setting	Switch positions <sup>1</sup>	Description
SW1	Force cooling		Press SW1 to enter the forced cooling function; Press it again to exit the forced cooling function.
SW2	Spot check		Spot check button
S1	S1-1		S1-1 is ON, Forced implementation of old indoor unit protocol S1-1 is OFF, Automatically adapting to indoor unit protocol( default)
	S1-2		S1-2 is ON, Clearing of indoor unit address S1-2 is OFF, Automatic addressing ( default)
	S1-3		S1-3 is ON, Automatically judging EXV control mode of ODU in cooling mode S1-3 is OFF, ODU EXV of forced discharge temperature control in cooling mode ( default)
S2	S2=000		First enabled priority mode(default)
	S2=100		Cooling priority mode
	S2=010		Automatic selection of priority mode
	S2=001		In response to cooling mode only
	S2=110		In response to heating mode only
	S2=011		Heating priority mode
S3	S3=000		ODU capacity: 8KW
S4	S4=0000		Network address of ODU: 0(default)
	S4=1000		Network address of ODU: 1
	S4=0100		Network address of ODU: 2
	S4=1100		Network address of ODU: 3
	S4=0010		Network address of ODU: 4
	S4=1010		Network address of ODU: 5
	S4=0110		Network address of ODU: 6
	S4=1110		Network address of ODU: 7

Notes:

1. Black denotes the switch position.



Figure 4-1.3: BCHB040(50,60,70)Q0A6-DTM115(140,160,190) model outdoor unit main PCB



Figure 4-1.4: BCHB040(50,60,70)Q0A6-DTM115(140,160,190) model outdoor unit communication switchboard

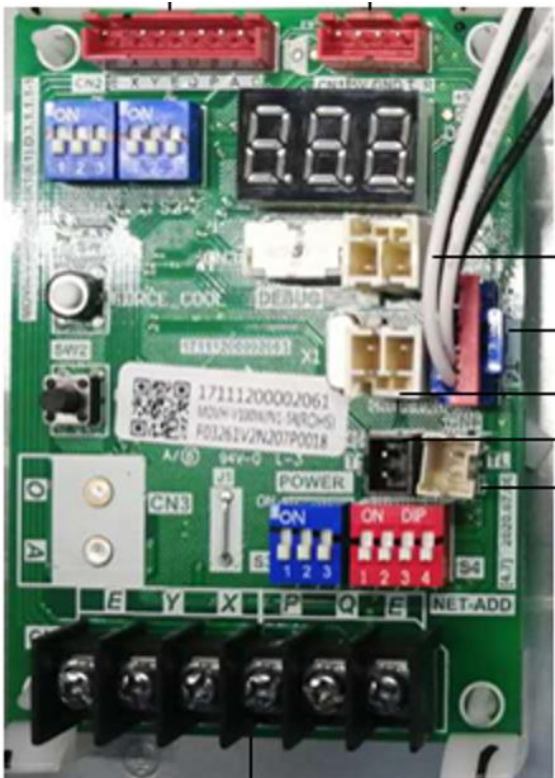

Table 4-1.2: BCHB040(50,60,70)QQA6-DTM115(140,160,190) model outdoor unit main PCB switch settings























Switch	Setting	Switch positions <sup>1</sup>	Description
SW1	Force cooling		Press SW1 to enter the forced cooling function; press it again to exit the forced cooling function.
SW2	Spot check		Spot check button
S1	S1-1		S1-1 is ON, Forced implementation of old IDU protocol S1-1 is OFF, Automatic selection of the new or old protocol (default)
	S1-2		S1-2 is ON, forced clearing of IDU address S1-2 is OFF, Automatic addressing(default)
	S1-3		S1-3 is ON, automatically judging EXV control mode of ODU in cooling mode S1-3 is OFF, ODU EXV of forced discharge temperature control in cooling mode(default)
S2	S2=000		First on priority mode (by default)
	S2=100		Cooling priority mode
	S2=010		Automatic priority mode
	S2=001		In response to cooling mode only
	S2=110		In response to heating mode only
	S2=011		Heating priority mode
S3	S3=100		ODU capacity DIP <sup>2</sup> : 10KW
	S3=010		ODU capacity DIP: 12KW
	S3=110		ODU capacity DIP: 14KW
	S3=001		ODU capacity DIP: 16KW

Table continued on next page...

Table 4-1.2: BCHB040(50,60,70)QQA6-DTM115(140,160,190) model outdoor unit main PCB switch settings (continued)

Switch	Setting	Switch positions <sup>1</sup>	Description
S4	S4=0000		Network address of ODU: 0(default)
	S4=1000		Network address of ODU: 1
	S4=0100		Network address of ODU: 2
	S4=1100		Network address of ODU: 3
	S4=0010		Network address of ODU: 4
	S4=1010		Network address of ODU: 5
	S4=0110		Network address of ODU: 6
	S4=1110		Network address of ODU: 7

Notes:

1. Black denotes the switch position.
2. The capacity dial code has been set in the factory, and market operation is prohibited.



Figure 4-1.3: BCHB080Q0A9-DTM200 model outdoor unit main PCB

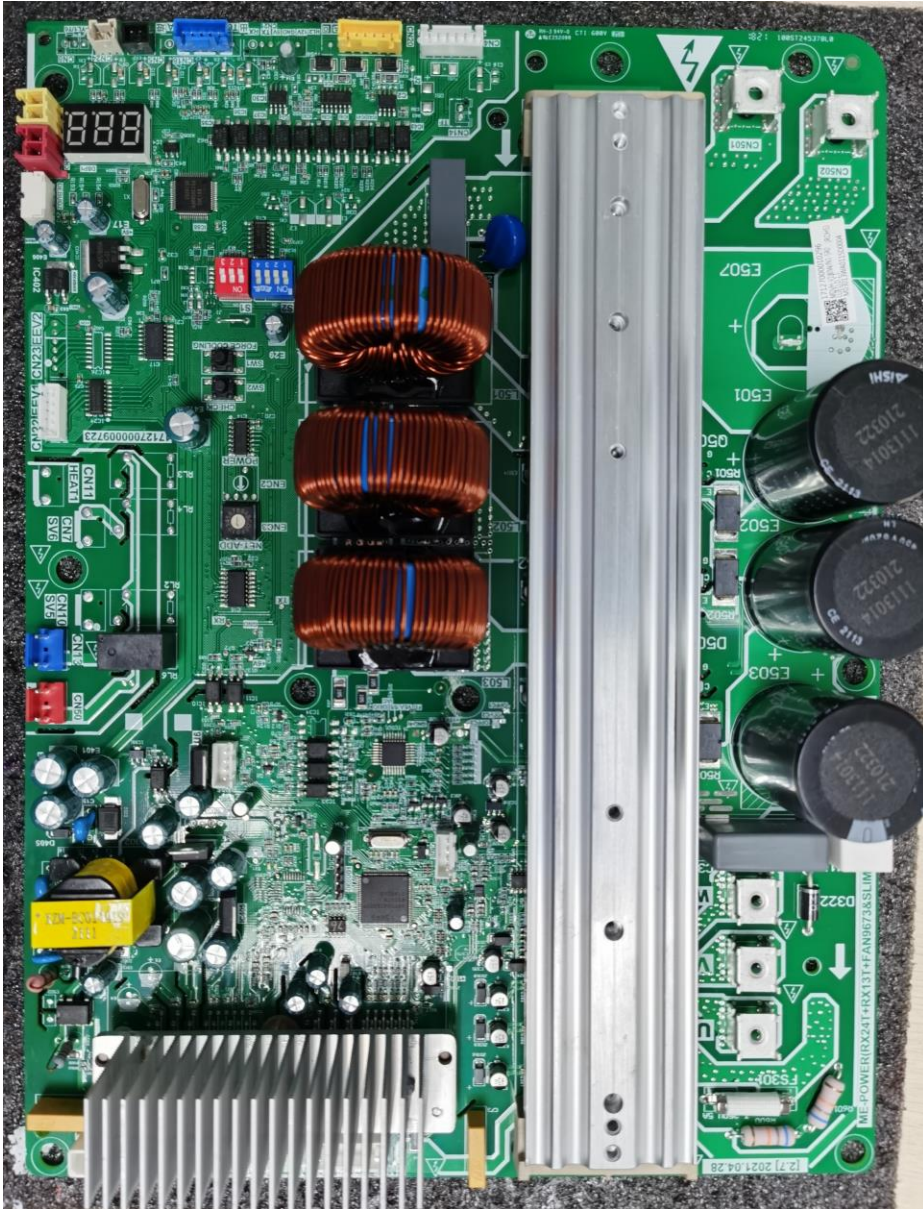









Table 4-1.2: 60 model outdoor unit main PCB switch settings

Switch	Setting	Switch positions <sup>1</sup>	Description
SW1	Force cooling		Press SW1 to enter the forced cooling function; press it again to exit the forced cooling function.
SW2	Spot check		Spot check button
ENC3	Network address		Outdoor unit Network Address (Valid at 0-7 ,default is 0)
S1	S1-1	ON OFF 1 2 3	S1-1 is ON, Forced implementation of old IDU protocol S1-1 is OFF, Automatic selection of the new or old protocol (default)
	S1-2	ON OFF 1 2 3	S1-2 is ON, forced clearing of IDU address S1-2 is OFF, Automatic addressing(default)
	S1-3	ON OFF 1 2 3	S1-3 is OFF, Automatically judging EXV control mode of ODU in cooling mode (Select cooling capacity requirement for modification) S1-3 is ON,ODU EXV of forced discharge temperature control in cooling mode, forced T2B average control for cooling capacity requirement (Default is OFF)

Table continued on next page...



Table 4-1.2: BCHB080Q0A9-DTM200 model outdoor unit main PCB switch settings (continued)

S2	S2=0000		First on priority mode (by default)
	S2=1000		Cooling priority mode
	S2=0100		Automatic priority mode
	S2=1100		In response to heating mode only
	S2=0010		In response to cooling mode only
	S2=0110		Heating priority mode
	S2-4		Silent Mode (S2-4 is OFF: No silent mode. S2-4 is ON: Silent mode; default is off)

Notes:

1. Black denotes the switch position.

Table 4-1.3: Spot check display table (for all model)

No.	Parameters displayed on DSP	Remarks
0	Operating frequency	Actual value = value displayed
1	Operating mode	Refer to Note 1
2	Operating fan speed level	Refer to Note 2
3	Total capacity requirement of indoor units	
4	Total capacity requirement for the modified ODU	
5	T3 Condenser temperature(°C)	Actual value = value displayed
6	T4 Outdoor ambient temperature(°C)	Actual value = value displayed
7	TP discharge temperature(°C)	Actual value = value displayed
8	TF invert module Temperature(°C)	Actual value = value displayed
9	TL refrigerant cooling tube temperature (°C)	Actual value = value displayed
10	EXVA position	Actual value = value displayed× 8
11	Actual current (A)	Actual value = value displayed
12	Inverter compressor current (A)	Actual value = value displayed
13	Actual voltage (V)	Actual value = value displayed
14	DC bus voltage (V)	Actual value = value displayed
15	Indoor heat exchanger pipe (T2/T2B) average temperature (°C)	Actual value = value displayed
16	T2A condenser temperature	Actual value = value displayed
17	Total number of IDUs	Actual value = value displayed
18	Number of Operating IDUs	
19	Model name	
20	System address	ODU address in the centralized control
21	Compressor error code	
22	Priority mode	Refer to Note 3
23	Program version number	
24-33	Last 10 times error protection code <sup>4</sup>	Refer to Note 4
34	Display "--"	

Notes:

1. Operating mode:
  - 0: standby; 2: cooling; 3: heating; 4: forced cooling.
2. The fan speed index is related to the fan speed in rpm and can take any integer value in the range 0 (0-off) to 16 (fastest).

Fan speed index	Fan speed (rpm)					
	28	36	42	48	56	60
0	0	0	0	0	0	0
1	120	120	120	120	120	120
2	150	150	150	150	150	150
3	180	180	180	180	180	180
4	210	210	210	210	210	210
5	240	240	240	240	240	240
6	270	270	270	270	270	270
7	300	300	300	300	300	300
8	360	350	350	350	350	350
9	400	400	400	400	400	400
10	440	460	460	460	460	460
11	520	520	520	520	520	520
12	600	630	630	630	630	630
13	680	720(Cooling)/750(Heating)	720(Cooling)/750(Heating)	750	750	750
14	750	780	780	800	800	800
15	800	/	/	/	/	830
16	/	/	/	/	/	850

3. Priority mode:
  - 0: first ON priority; 1: cooling priority; 2: Automatic selection of priority mode; 3: heating only; 4: cooling only; 5: heating priority
4. "nn" is displayed if no error or protection events have occurred since start-up; it displays all error protection code if the number of error protection codes are less than 10 since start-up.

# Electrical Components and Wiring Diagrams

1 Outdoor Unit Electric Control Box Layout .....	33
2 Outdoor Unit Main PCB .....	35
3 Wiring Diagrams.....	42

# 1 Outdoor Unit Electric Control Box Layout

Figure 5-1.1: Front view of BCHB030Q0A4-DTM090 model electric control box

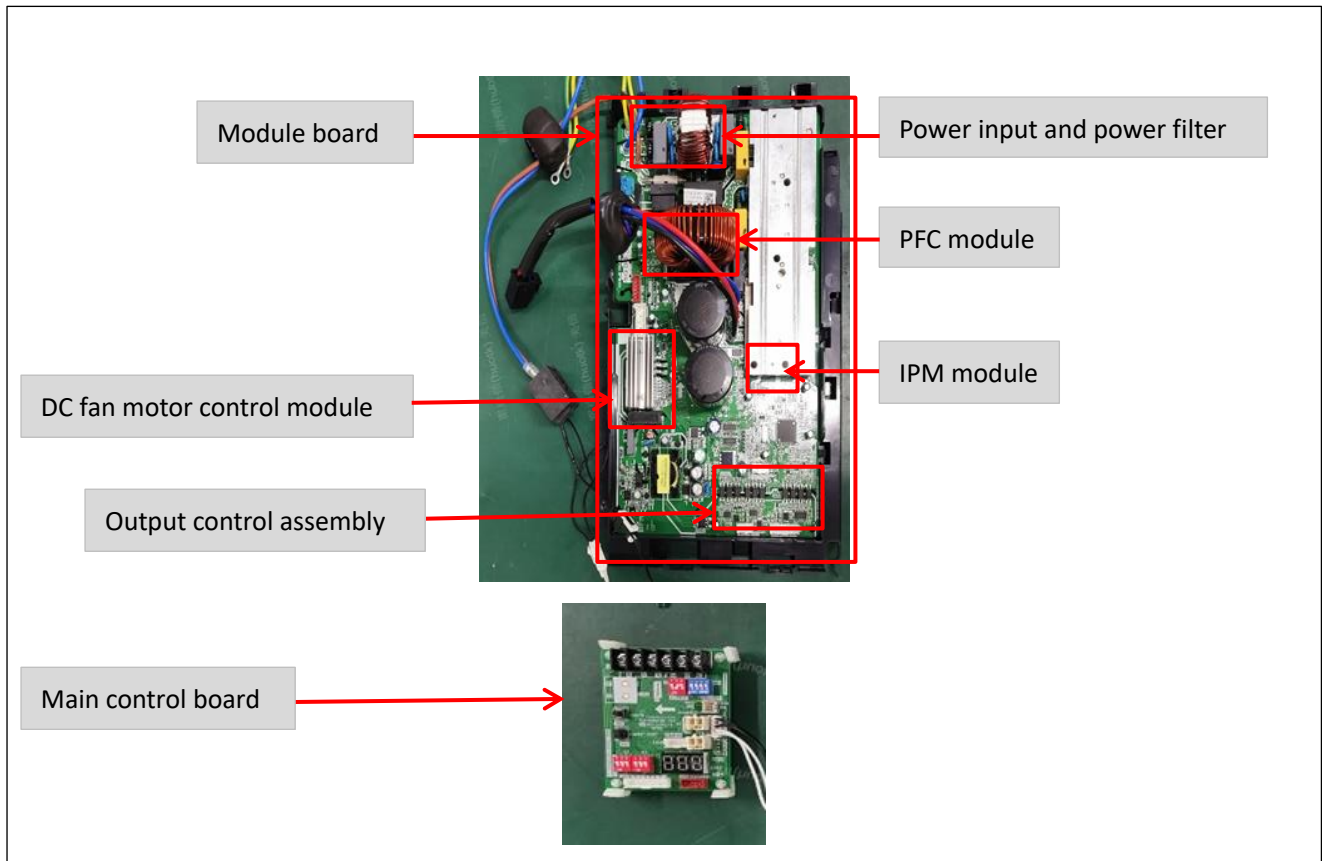

Figure 5-1.2: Front view of BCHB040(50,60,70)Q0A6-DTM115(140,160,190) model electric control box

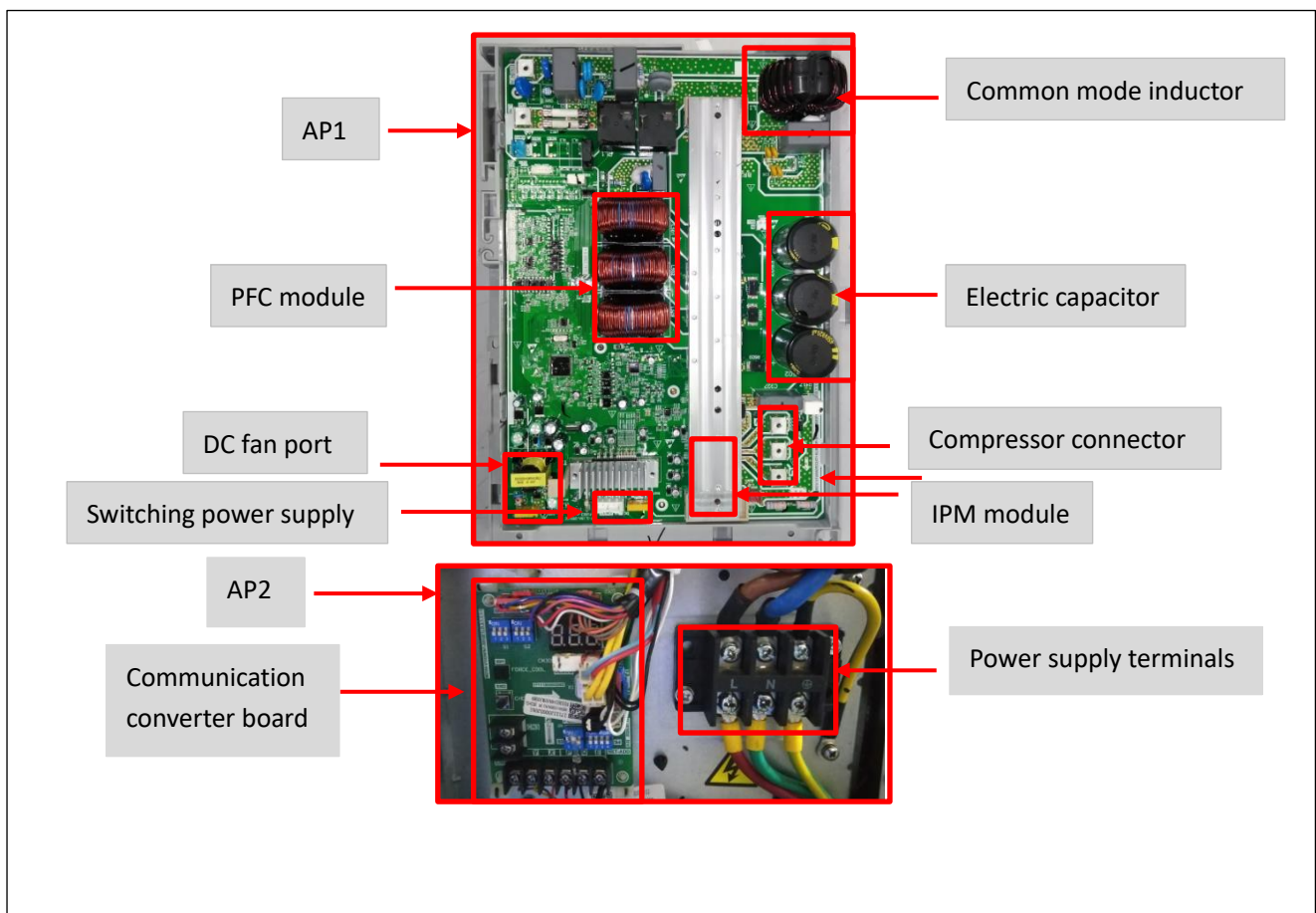
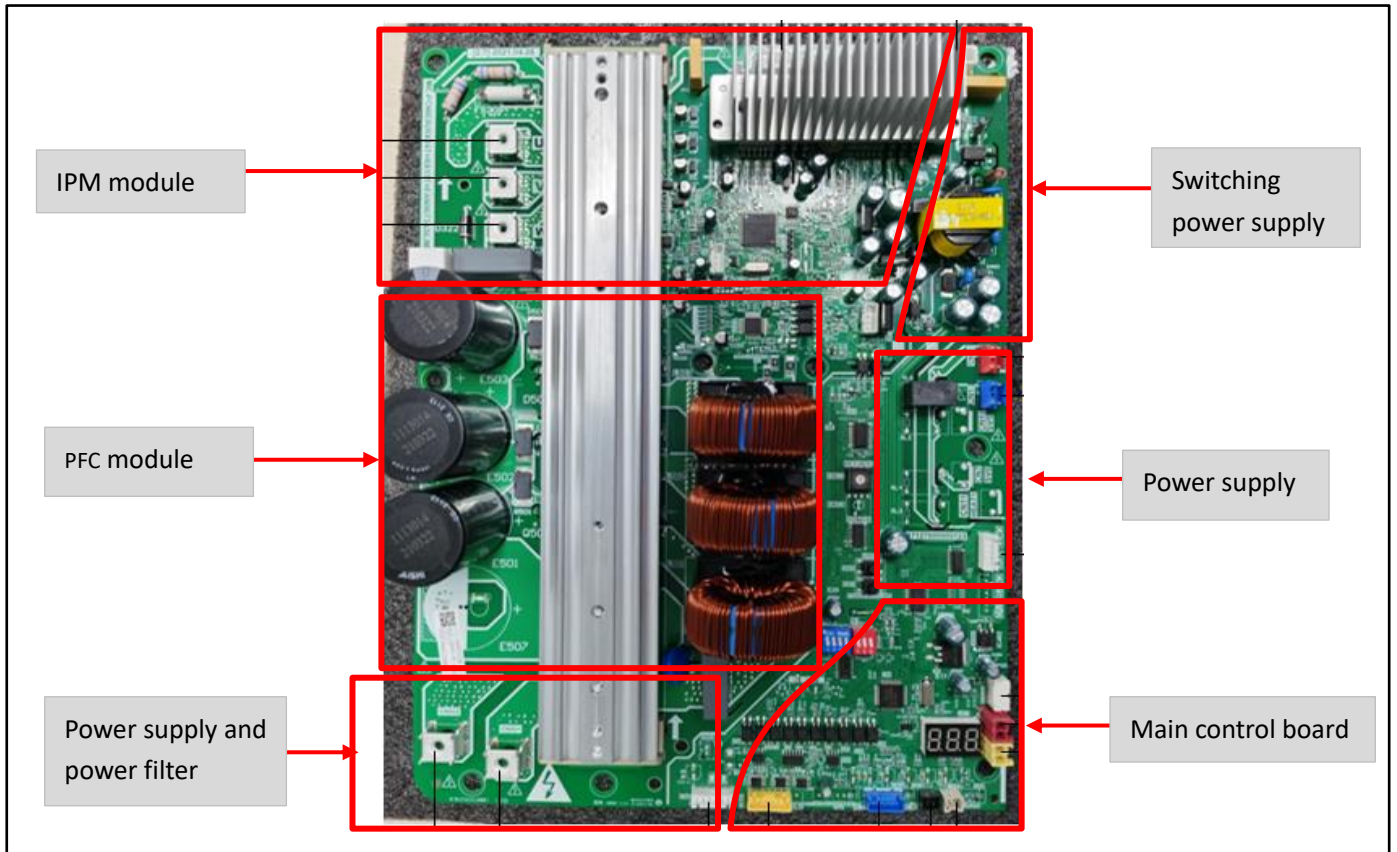

Figure 5-1.3: Front view of BCHB080Q0A9-DTM200 model electric control box



## 2 Outdoor Unit Main PCB

### 2.1 Ports

Figure 5-2.1: BCHB030Q0A4-DTM090 model outdoor unit main PCB ports

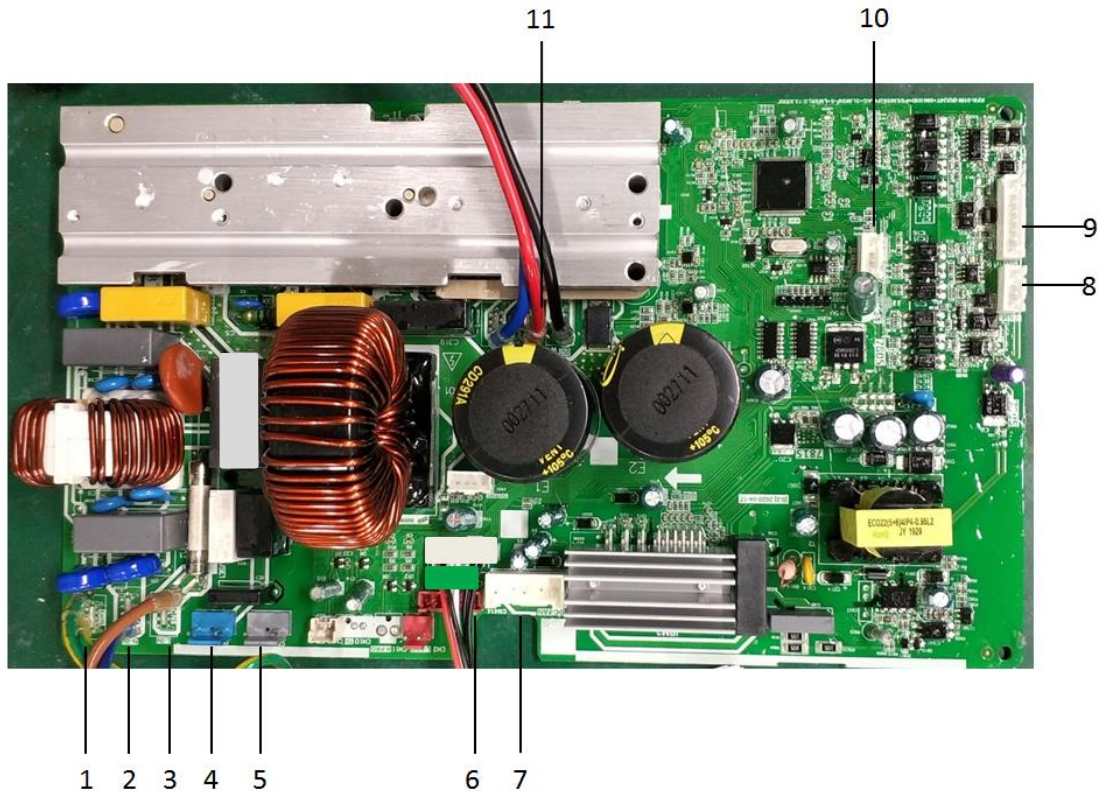

Table 5-2.1: BCHB030Q0A4-DTM090 model main PCB ports

Label in Figure 5-1.1	Port code	Content	Port voltage
1	CN6/CN6-1	Earth	0V
2	CN7	Power input	AC 220V
3	CN8	Power input	AC 220V
4	CN60	Four way valve	AC 220V
5	CN16	Reserved	/
6	CN18	Electronic expansion valve port	Pin 1: DC12V; Other pins: Dynamic change
7	CN414	Fan motor port	DC 240-350V
8	CN30	Main board communication converter board communication port	DC 0-5V
9	CN5	Communication port between outdoor unit and indoor units; Energy meter communication port	DC 2.5-5V
10	CN507	Chip burning port	DC 5V
11	U/V/W	Compressor U/V/W output	DC 240-350V



Figure 5-2.2: BCHB040(50,60,70)Q0A6-DTM115(140,160,190)model outdoor unit main board ports

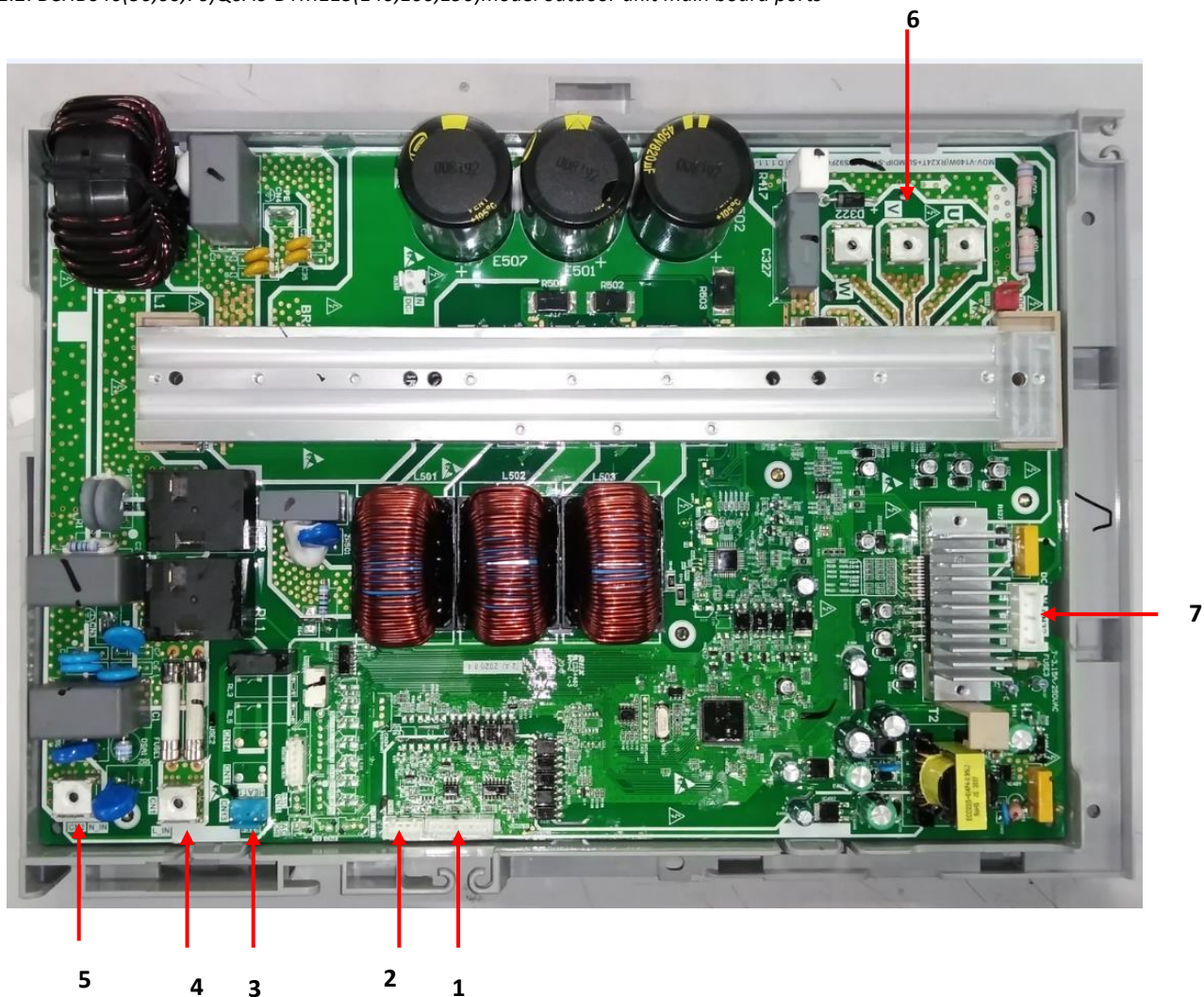

Table 5-2.2: BCHB040(50,60,70)Q0A6-DTM115(140,160,190) model outdoor unit main board ports

Label in Figure 5-1.2	Code	Content	Port voltage
1	CN27	R T communication port	0-5V DC
2	CN5	Main board 5V power supply port; communication port between main board and module board	5V DC and 0~5V DC
3	CN13	Four way valve	0V or 220-240V AC
4	CN1	AC power input	L, 220-240V AC
5	CN2	AC power input	N, 220-240V AC
6	UVW	Compressor connection	$V_{uv} = V_{uw} = V_{vw}$ 0-380VAC
7	CN32	DC fan port	300-350V DC

Figure 5-2.3: BCHB040(50,60,70)Q0A6-DTM115(140,160,190) model outdoor unit Communication converter board PCB Ports

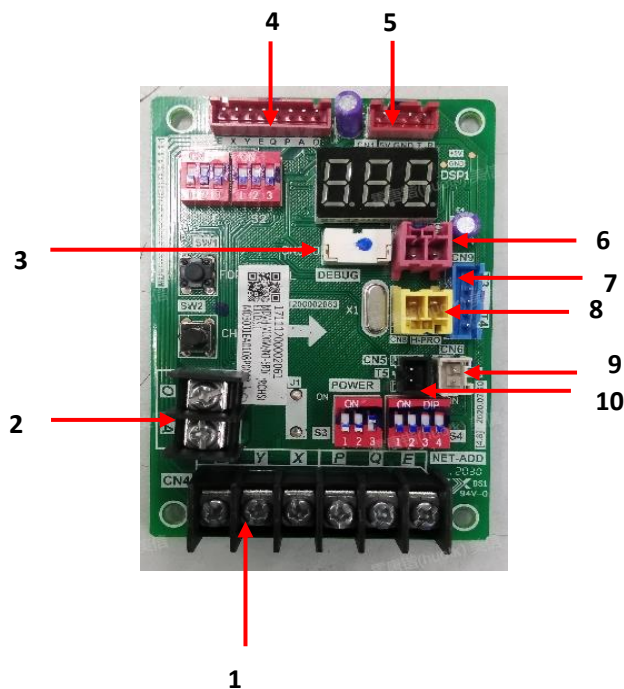

Table 5-2.3: BCHB040(50,60,70)Q0A6-DTM115(140,160,190) model communication converter board PCB ports

Label in Figure 5-1.3	Port code	Content	Port voltage
1	CN4	P Q E X Y E communication port	2.5-2.7V DC
2	CN3	Digital multimeter communication port	0-5V DC
3	CN300	Chip burning port	0-5V DC
4	CN2	P Q E X Y E communication port O A communication port (reserved)	0-5V DC
5	CN1	Main board 5V power supply port; communication port between main board and module board	5V DC and 0~5V DC
6	CN7	Signal input port of system low pressure detect switch	0 or 5V DC
7	CN9	T3/T4 port	0-5V DC
8	CN8	Signal input port of system high pressure detect switch	0-5V DC
9	CN6	Signal input port of Refrigerant radiator temperature	0-5V DC
10	CN5	Signal input port of Discharge temperature	0-5V DC



Figure 5-2.4: BCHB080Q0A9-DTM200 model outdoor unit main board ports

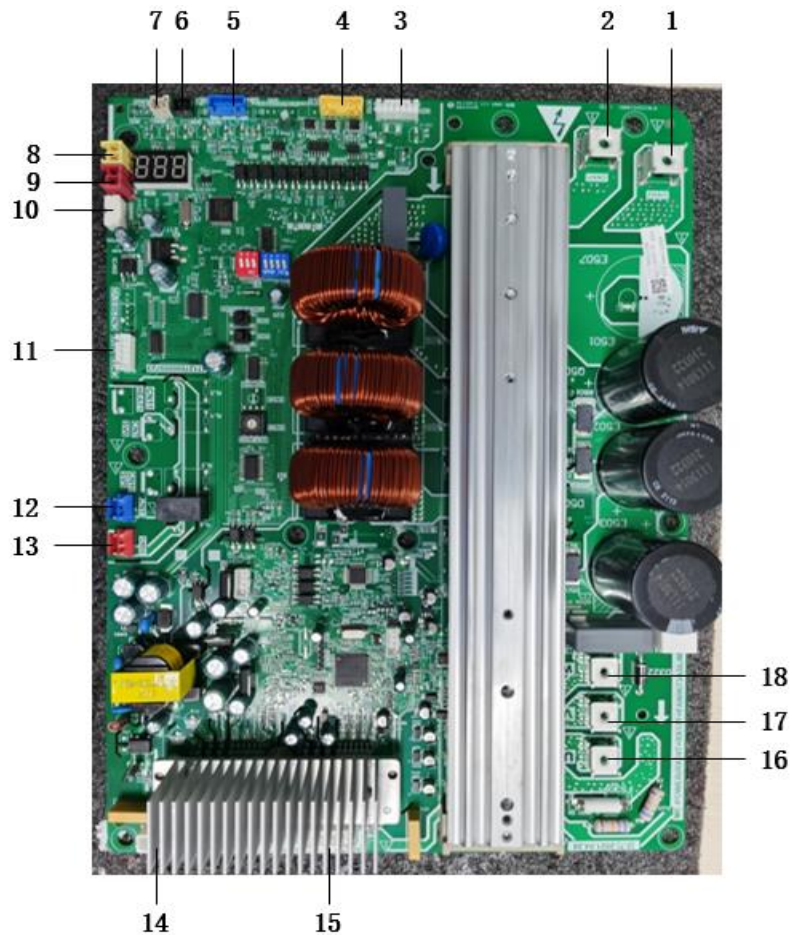

Table 5-2.4: BCHB080Q0A9-DTM200 model outdoor unit main board ports

Label in Figure 5-1	Port code	Content	Port voltage
1	CN502	Power input port	AC 220V
2	CN501	Power input port	AC 220 V
3	CN4	Relay control port	DC 12V
4	CN20	Communication port between outdoor unit and indoor unit	DC 2.5~5V
5	CN18	Outdoor unit heat exchanger pipe temperature/outdoor environment temperature detection port	DC 0~5V
6	CN5	Compressor discharge temperature detection port	DC 0~5V(in dynamic change)
7	CN24	Compressor discharge temperature detection port	DC 0~5V(in dynamic change)
8	CN9	Signal input port of system high pressure detect switch	DC 0~5V(in dynamic change)
9	CN12	Signal input port of system low pressure detect switch	DC 0~5V(in dynamic change)
10	CN27	Online Programmable Port	DC 5V
11	CN22	EEV driving port	The first pin: DC12V; The other four pins: in dynamic change
12	CN13	Load output port(4-way valve)	AC 220
13	CN50	Power input port	AC 220V
14	CN1	Port	DC 380
15	CN19	DC fan port	DC 380
16	U	Compressor's U phase voltage output port	DC 0-300 (in dynamic change)
17	V	Compressor's V phase voltage output port	DC 0-300 (in dynamic change)
18	W	Compressor's W phase voltage output port	DC 0-300 (in dynamic change)

Figure 5-2.5: BCHB080Q0A9-DTM200 model outdoor unit filter board Ports

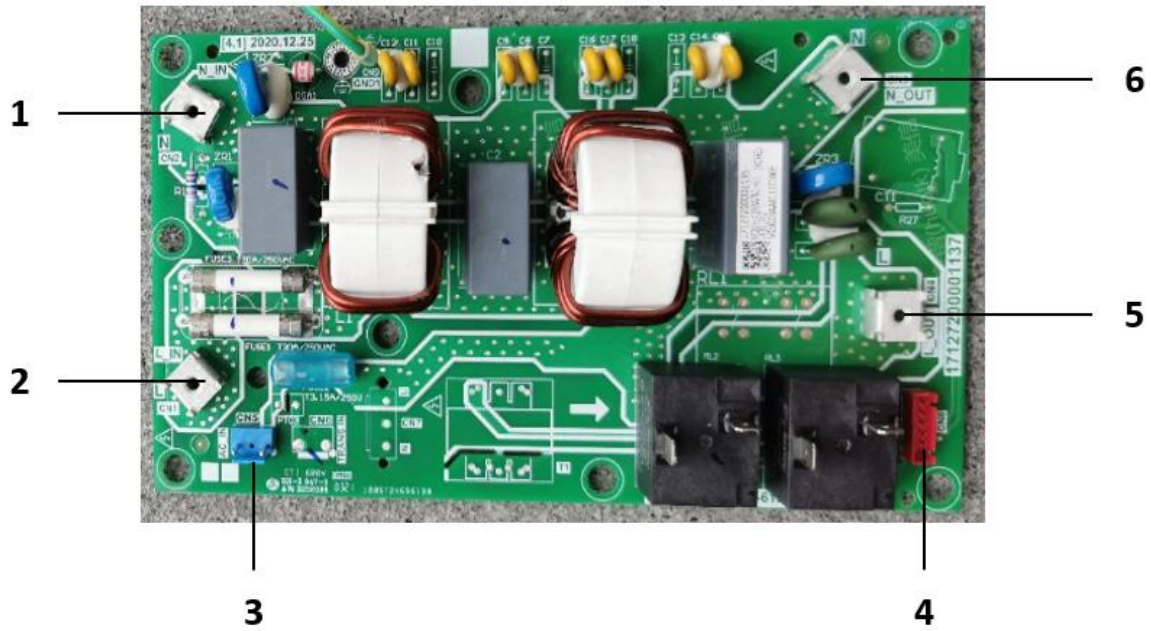



Table 5-2.4: BCHB080Q0A9-DTM200 model filter board ports

Label in Figure	Port code	Content	Port voltage
1	CN2	AC Power Input	AC 220V
2	CN1	AC Power Input	AC 220V
3	CN5	AC Power Output	AC 220V
4	CN8	Relay control port	DC +12V
5	CN4	AC Power Output	AC 220V
6	CN3	AC Power Output	AC 220V

## 2.2 Components

### 2.2.1 LED indicator

Table 5-2.5: LED indicator

Indicator	LED indicator function and status	
LED101	Inverter module operating indicator (red light). Continuously on if the compressor is running normally, quick flashing (5Hz) if an inverter module error has occurred <sup>1</sup> and slow flashing (1Hz) if the machine is in standby mode.	

Notes:

1. If an inverter module error occurs, refer to Part 6.

### 2.2.2 Function of buttons SW1 to SW2

Table 5-2.6: Function of buttons SW1 to SW2

Model	Button	Function	Picture
36-60	SW1	Force cooling button	
	SW2	Check button	

### 2.2.3 System check button

On pressing Spot check button, the parameters listed in Table 5-2.6 will be displayed in sequence.

Table 5-2.7: BCHB030(40,50,60,70,80)Q0A4-DTM090(115,140,160,190,200) model system check

No.	Parameters displayed on DSP	Remarks
0	Operating frequency	Actual value = value displayed
1	Operating mode	Refer to Note 1
2	Operating fan speed level	Refer to Note 2
3	Total capacity requirement of indoor units	
4	Total capacity requirement for the modified ODU	
5	T3 Condenser temperature(°C)	Actual value = value displayed
6	T4 Outdoor ambient temperature(°C)	Actual value = value displayed
7	TP discharge temperature(°C)	Actual value = value displayed
8	TF invert module Temperature(°C)	Actual value = value displayed
9	TL refrigerant cooling tube temperature (°C)	Actual value = value displayed
10	EXVA position	Actual value = value displayed× 8
11	Actual current (A)	Actual value = value displayed
12	Inverter compressor current (A)	Actual value = value displayed
13	Actual voltage (V)	Actual value = value displayed
14	DC bus voltage (V)	Actual value = value displayed
15	Indoor heat exchanger pipe (T2/T2B) average temperature (°C)	Actual value = value displayed
16	T2A condenser temperature	Actual value = value displayed
17	Total number of IDUs	Actual value = value displayed
18	Number of Operating IDUs	
19	Model name	
20	System address	ODU address in the centralized control
21	Compressor error code	
22	Priority mode	Refer to Note 3
23	Program version number	
24-33	Last 10 times error protection code <sup>4</sup>	Refer to Note 4
34	Display "--"	

Notes:

1. Operating mode:
  - 0: standby; 2: cooling; 3: heating; 4: forced cooling.
2. The fan speed index is related to the fan speed in rpm and can take any integer value in the range 0 (0-off) to 15 (fastest). Please refer to *Table 4-1.3* note 2 in Part 4.
3. Priority mode:
  - 0: first ON priority; 1: cooling priority; 2: Automatic selection of priority mode; 3: heating only; 4: cooling only; 5: heating priority
4. "nn" is displayed if no error or protection events have occurred since start-up; it displays all error protection code if the number of error protection codes are less than 10 since start-up.

### 2.2.4 Digital display output

Table 5-2.8: Digital display output in different operating states

Outdoor unit state	Parameters displayed on DSP
Standby	The number of indoor units in communication with the outdoor unit
Normal operation	Compressor frequency
Error or protection	Error or protection code
System check	Refer to Table 5-2.6



### 3 Wiring Diagrams

Figure 5-3.1: BCHB030Q0A4-DTM090 model wiring diagram

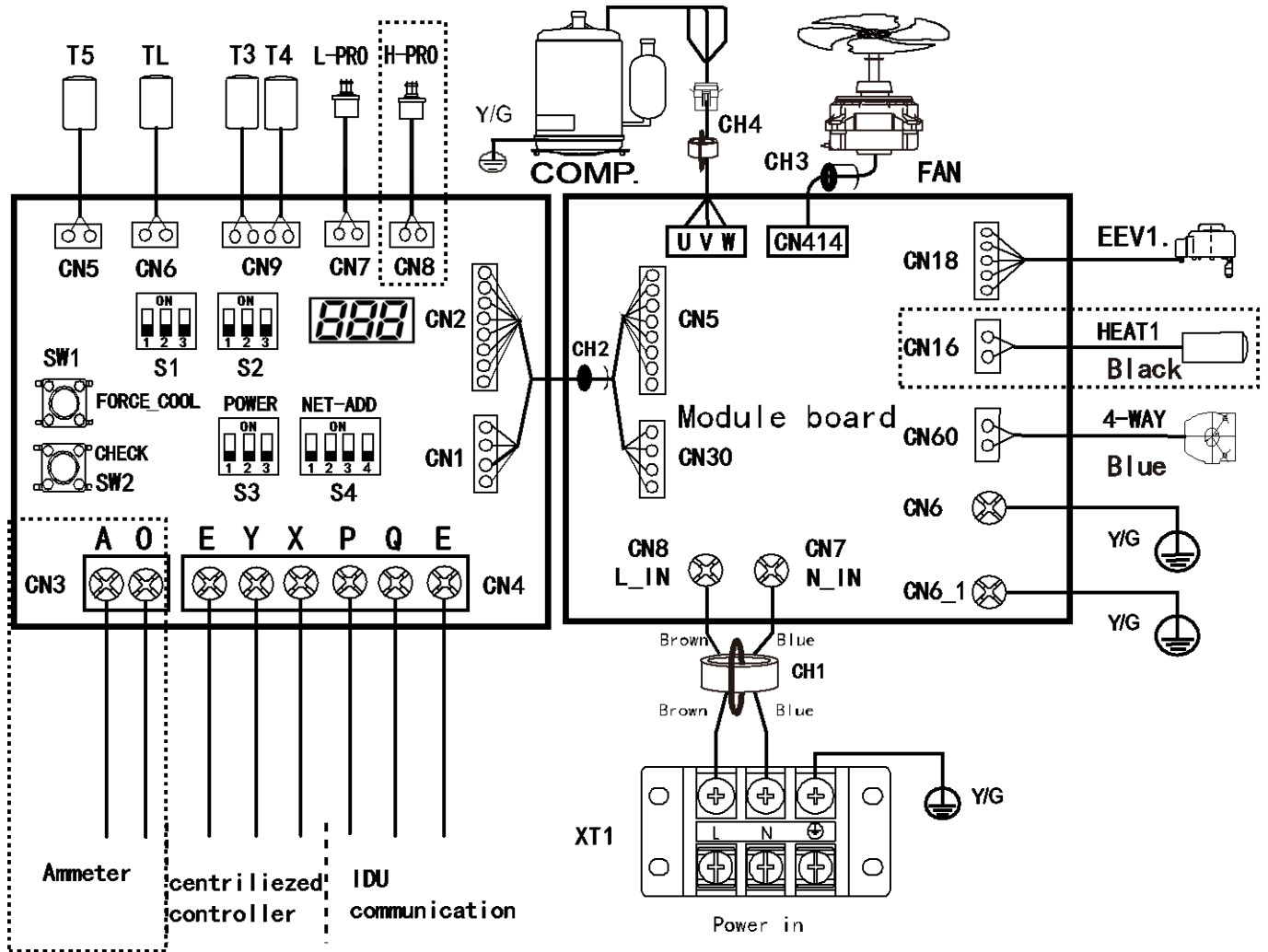

Component code	Description	Component code	Description
CH1-CH4	Magnetic ring	STF1	Four-way valve
COMP	Compressor	TL	Refrigerant radiator temperature sensor
EEV1	Electronic expansion valve	XT1	Power supply terminal
FAN	DC fan	T3	Outdoor heat exchanger temperature sensor
HEAT1	Crankcase heater	T4	Outdoor ambient temperature sensor
H-PRO	High pressure on/off switch(default)	T5	Outdoor discharge temperature sensor
L-PRO	Low pressure on/off switch		

Figure 5-3.2: BCHB040(50,60,70)Q0A6-DTM115(140,160,190) model wiring diagram

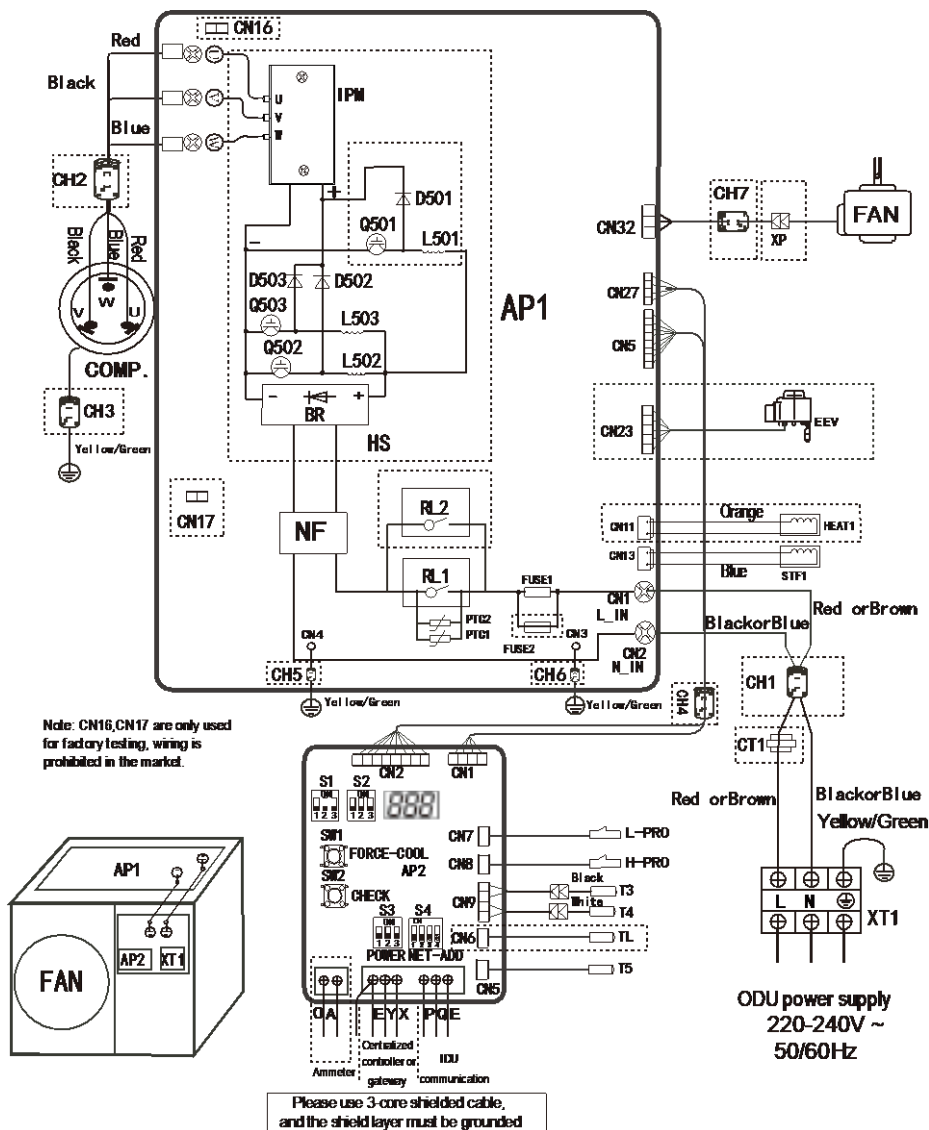

Component code	Description	Component code	Description
BR	Rectifier bridge stacking	RL1	Relay
CH1-CH7	Magnetic ring	STF1	Four-way valve
COMP.	Compressor	T3	Outdoor heat exchanger temperature sensor
CT1	AC current transformer	T4	Outdoor ambient temperature sensor
D501-D503	Fast-recovery diode	T5	Discharge temperature sensor
EEV	Electronic expansion valve	TL	Refrigerant radiator temperature sensor
FAN	DC fan	NF	Filter assembly
FUSE1-FUSE2	Fuse	AP1	Main control board
HEAT1	Crankcase heater	AP2	Spot check board
HS	Radiator	XT1	Power supply terminal
H-PRO	High pressure switch	XP	Connecting terminal
L-PRO	Low pressure switch	Q501-Q503	IGBT
L501-L503	PFC inductance	IPM	Inverter module

Figure 5-3.3: BCHB080Q0A9-DTM200 model wiring diagram

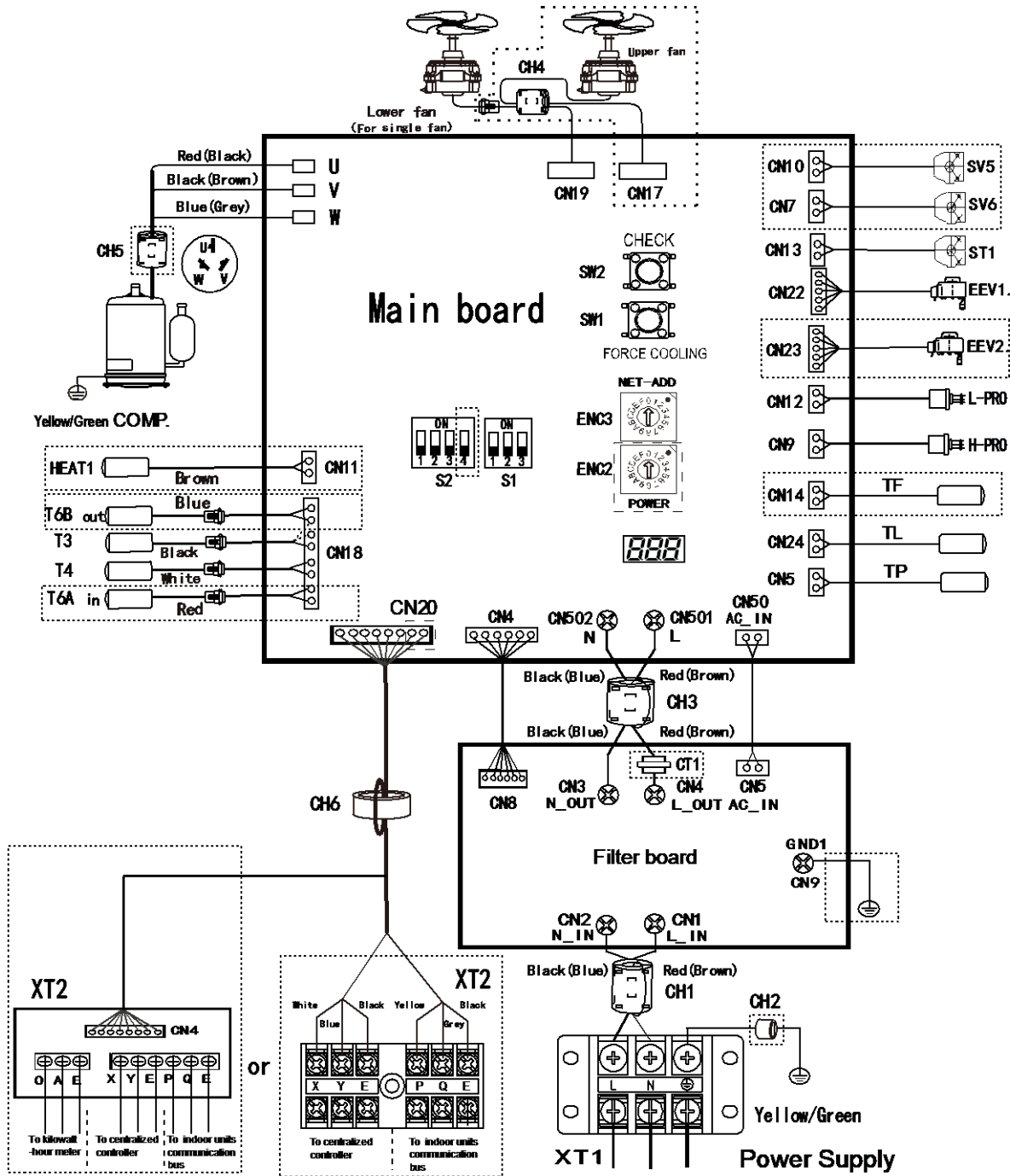

Component code	Description	Component code	Description
XT1	3-slot power supply terminal	H-PRO	High pressure switch
XT2	Communication converter board	L-PRO	Low pressure switch
CHI-CH6	Magnetic ring	STF1	Four-way valve
COMP.	Compressor	T3	Outdoor heat exchanger temperature sensor
CT1	AC current transformer	T4	Outdoor ambient temperature sensor
EEV1/EEV2	Electronic expansion valve	T5	Discharge temperature sensor
FAN1	Upper fan	TF	Radiator surface temperature sensor
FAN2	Lower fan (connected if there's any)	TL	Refrigerant radiator temperature sensor
HEAT1	Crankcase heater	SV5/SV6	Solenoid valve

---

# Part 6

# Diagnosis and Troubleshooting

1 Error Code Table.....	46
2 Troubleshooting .....	47



# 1 Error Code Table

Table 6-1.1: Error code table

Error code	Content	Note
C0	Communication fault between main control board and communicate converter board	28-56 models
H0	Communication fault between main control board and communicate converter board	60 model
E2	Communication fault between outdoor unit and indoor units	All models
E4	Outdoor heat exchanger temperature sensor(T3) or outdoor ambient temperature sensor(T4) error	All models
E5	Input voltage protection	All models
E6	DC fan protection	All models
E9	EEPROM Error	All models
E.9.	Compressor parameters mismatch	All models
Eb	E6 fault occurs more than six times in an hour.	All models
EF	PFC fault	All models
EH	Refrigerant radiator temperature sensor fault	All models
EP	Cooling ambient temperature lower than -15°C	All models
F1	DC bus voltage protection	All models
H4	L (L0/L1) fault occurs three times in one hour.	All models
H7	The number of online indoor units have decreased/increased	All models
HF	Indoor unit and outdoor unit program mismatch	All models
L0	IPM module protection	All models
L1	DC bus low voltage protection	All models
L2	DC bus high voltage protection	All models
L3	Other drive errors	All models
L4	MCE malfunction	All models
L5	Zero speed protection	All models
L7	Phase sequence error	All models
L8	Protection for compressor speed change > 15Hz	All models
L9	Protection for the difference between the setting speed and the running speed of the compressor > 15Hz	All models
PL	Radiator surface temperature protection	All models
P1	System high pressure protection	All models
P2	System low pressure protection	All models
P3	Overcurrent protection	All models
P4	Discharge temperature T5 protection	All models
P5	Outdoor condenser temperature T3 protection	All models
P8	Typhoon protection	All models
P9	Poor reversing of four-way valve	All models
PE	IDU evaporator temperature T2 protection	All models

## 2 Troubleshooting

### 2.1 Warning

#### Warning



- All electrical work must be carried out by competent and suitably qualified, certified and accredited professionals and in accordance with all applicable legislation (all national, local and other laws, standards, codes, rules, regulations and other legislation that apply in a given situation).
- Power-off the outdoor units before connecting or disconnecting any connections or wiring, otherwise electric shock (which can cause physical injury or death) may occur or damage to components may occur.

## 2.2 C0: Communication fault between main board and communicate converter board (For 28-56 models)

### 2.2.1 Digital display output

# C0

### 2.2.2 Description

- Communication fault between main board and communicate converter board.
- The system stops running.
- Error code is displayed on the outdoor unit PCB.

### 2.2.3 Trigger / recover condition

- Trigger condition: Communicate converter board and ODU main control board cannot communicate.
- Recover condition: Communication go back to normal.
- Reset method: Resume automatically.

### 2.2.4 Possible causes

- Interference from high voltage wires or other sources of electromagnetic radiation.
- Communicate converter board is damage.
- Communicate wire port is loose or connecter surface is corrosive, or water drop lead to poor contact.
- Communicate wire break or poor contact for reasons (such as rat beat, or bond and connection).

### 2.2.5 Procedure

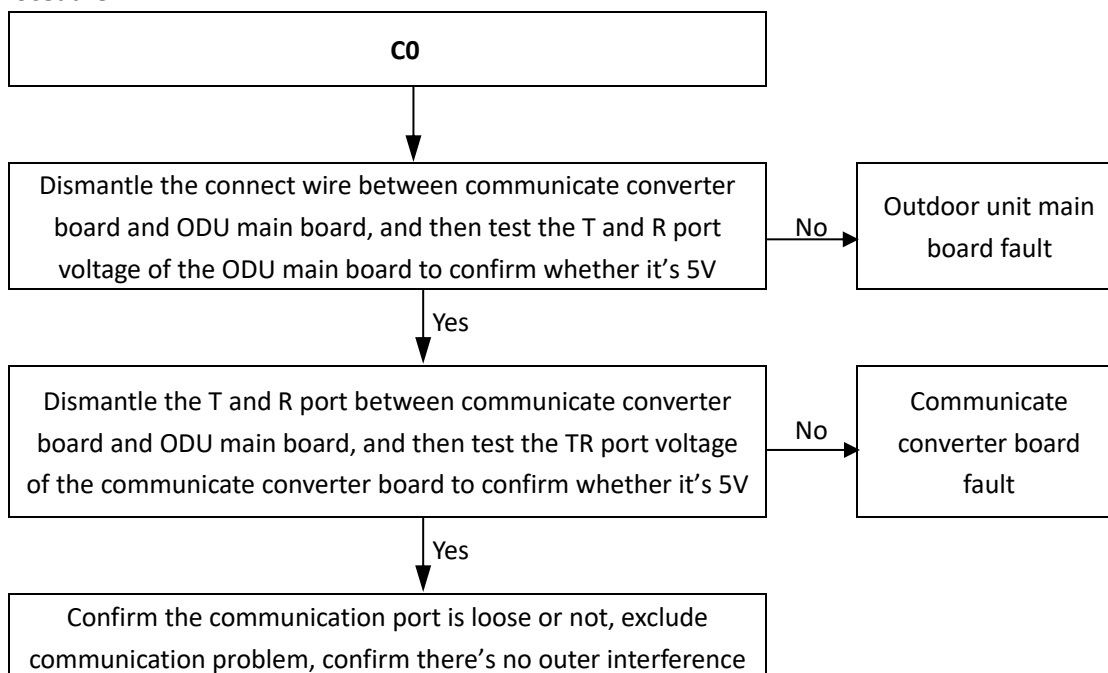

## 2.3 H0: Communication fault between main board and communicate converter board (For 60 model)

### 2.3.1 Digital display output

# H0

### 2.3.2 Description

- Communication fault between main board and motor control module.

### 2.3.3 Trigger / recover condition

- Trigger condition: Motor control module and ODU main control board cannot communicate.
- Recover condition: Communication go back to normal.
- Reset method: Resume automatically.

### 2.3.4 Possible causes

- Main control board is damage.

### 2.3.5 Procedure

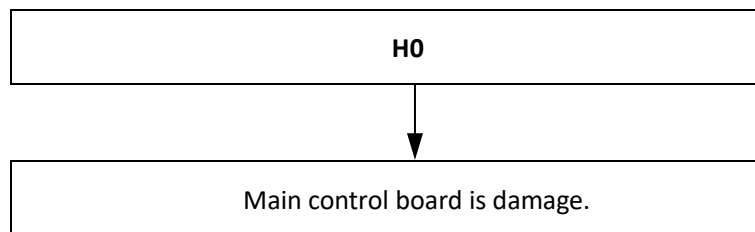

## 2.4 E2: Communication error between outdoor unit and indoor units (For all models)

### 2.4.1 Digital display output

# E2

### 2.4.2 Description

- Communication error between outdoor unit and indoor units.
- The system stops running.
- Error code is displayed on the outdoor unit PCB.

### 2.4.3 Trigger / recover condition

- Trigger condition: Indoor units and the outdoor unit cannot communicate for 2 minutes after the system is powered on for 20 minutes.
- Recover condition: Communication go back to normal.
- Reset method: Resume automatically.

### 2.4.4 Possible causes

- Communication wires between indoor and outdoor units did not connected properly.
- Indoor unit power supply abnormal.
- Loosened wiring within electric control box.
- Interference from high voltage wires or other sources of electromagnetic radiation.
- Communication wire too long.
- Damaged main PCB or electric control box communication terminals block.
- Communication wire break or poor contact for reasons (such as rat bite, or bond and connection).

### 2.4.5 Procedure

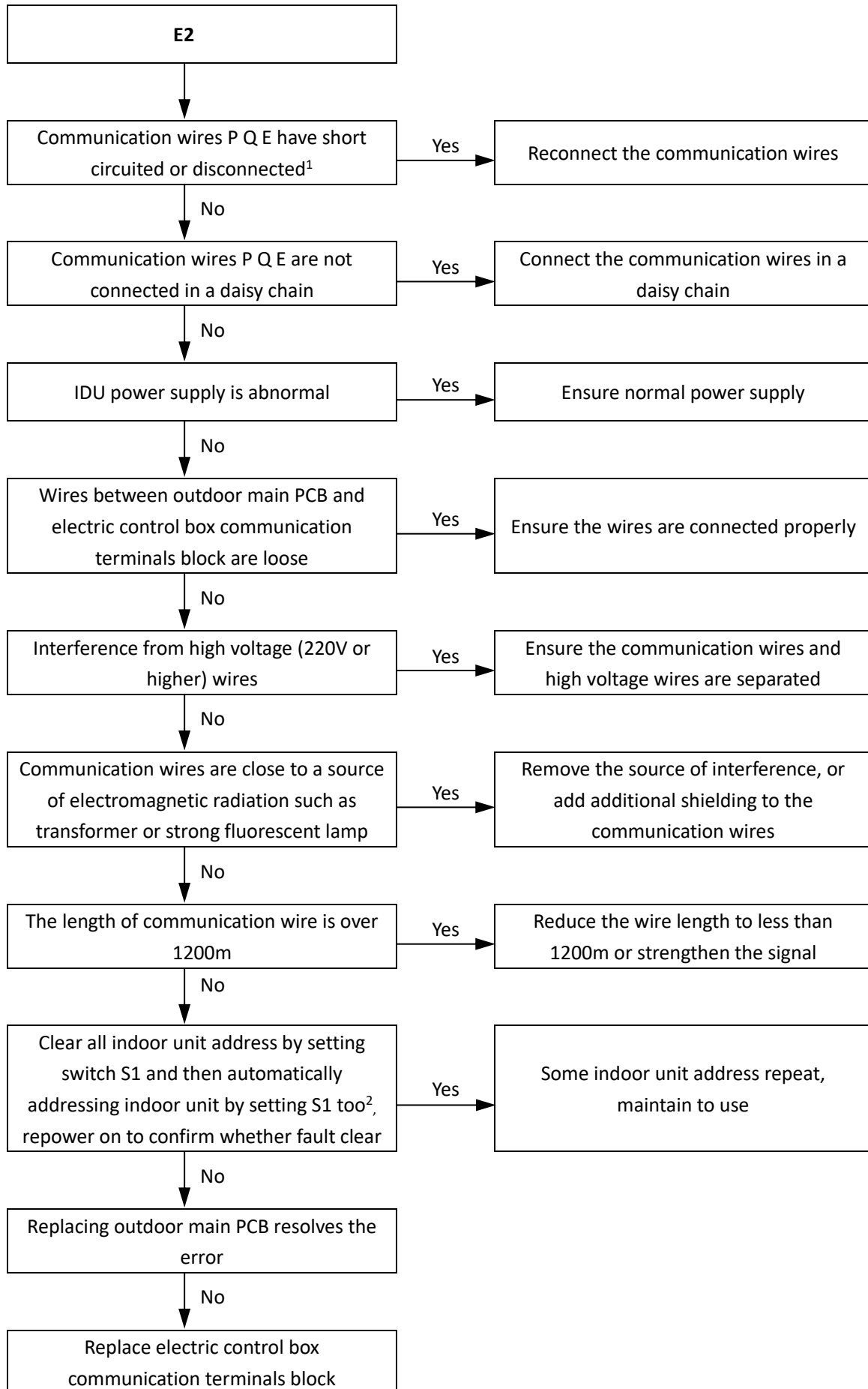

Notes:

1. Measure the resistance among P, Q and E. The normal resistance between P and Q is 120Ω, between P and E is infinite, between Q and E is infinite.
2. S1 switch setting as below table; for every times setting, you need to repower on to make the switch dial function works.

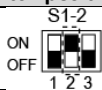
Switch	Switch positions	Description
S1		S1-2 is ON, forced clearing of IDU address S1-2 is OFF, Automatic addressing(default)

- Press indoor unit's receiver button for 5 seconds, the indoor unit's communication address code is displayed.

Table 6-2.1: Communication address code

Director light	Running	Timer	Fan/defend cold fan	Warning
Code	8	4	2	1

- Press it for 10 seconds, power code is displayed. Check each unit's address code.

Table 6-2.2: Power code

Address	0	1	2	3	4	5	6	7	8	9
Capacity (×100W)	22	28	36	45	56	71	80	90	112	140
HP	0.8	1.0	1.2	1.6	2.0	2.5	3.0	3.2	4.0	5.0

**For example:**

Press the button for 5 seconds:

If the “running” and “warning” lights are normally on, that means the address code is  $9=(8+1)$

If the lights are blink, the address code should plus 16, so the address code is  $25=16+(8+1)$

Press the button for 10 seconds:

If the “timer” and “warning” lights are normally on, that means the capacity code is  $5=(4+1)$  and the capacity of indoor unit is  $71 \times 100W(2.5HP)$ .

- If the signal is weak, connect a 120Ω resistor between P and Q of the farthest indoor unit, or connect a 0.5-1.5uF capacitor between P and Q of outdoor unit. Installation refers to Figure 6-2.1:

Figure 6-2.1: Indoor unit installation

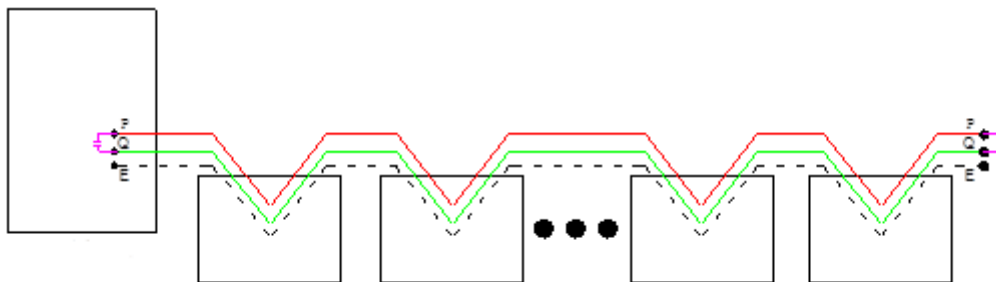

Notes:

- Communication wires should be shield wire and indoor units should be connected in series.

## 2.5 E4: Temperature sensor (T3/T4) fault (For all models)

### 2.5.1 Digital display output

# E4

### 2.5.2 Description

- Outdoor heat exchanger temperature sensor (T3) error or outdoor ambient temperature sensor (T4) error.
- The system stops running.
- Error code is displayed on the outdoor unit PCB.

### 2.5.3 Trigger / recover condition

- Trigger condition: The main control board cannot receive the feedback signal of temperature sensor T3 or T4.
- Recover condition: The main control board can receive the feedback signal of temperature sensor T3 or T4.
- Reset method: Resume automatically.

### 2.5.4 Possible causes

- Temperature sensor not connected properly or has malfunctioned.
- Temperature sensor port connect to the main board connector is loose.
- Damaged main PCB.

### 2.5.5 Procedure

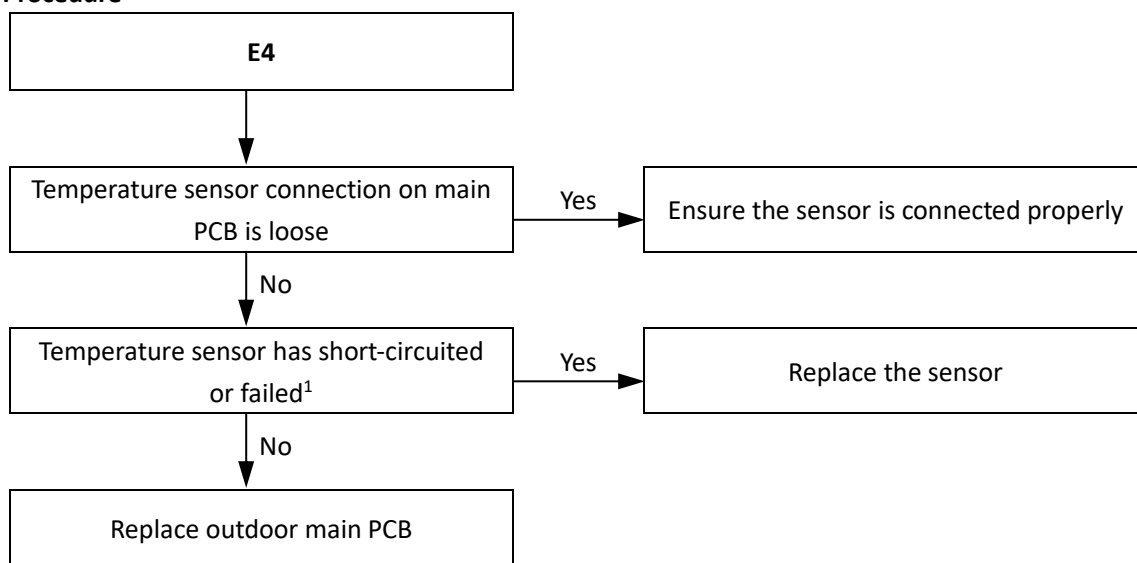

#### Notes:

1. Measure sensor resistance. If the resistance is too low, the sensor has short-circuited. If the resistance is not consistent with the sensor's resistance characteristics table, the sensor has failed.



## 2.6 E5: Abnormal power supply voltage (For all models)

### 2.6.1 Digital display output

# E5

### 2.6.2 Description

- Abnormal power supply voltage.
- The system stops running.
- Error code is displayed on the outdoor unit PCB.

### 2.6.3 Trigger / recover condition

- Trigger condition: Outdoor unit power supply phase voltage < 165V or > 265V.
- Recover condition: Outdoor unit power supply phase voltage is within 198V ~265V.
- Reset method: Resume automatically.

### 2.6.4 Possible causes

- Outdoor unit power supply voltage is abnormal.
- Loosened wiring within electric control box.
- Power wire or air switch selection is too small.
- Main PCB damaged.

### 2.6.5 Procedure

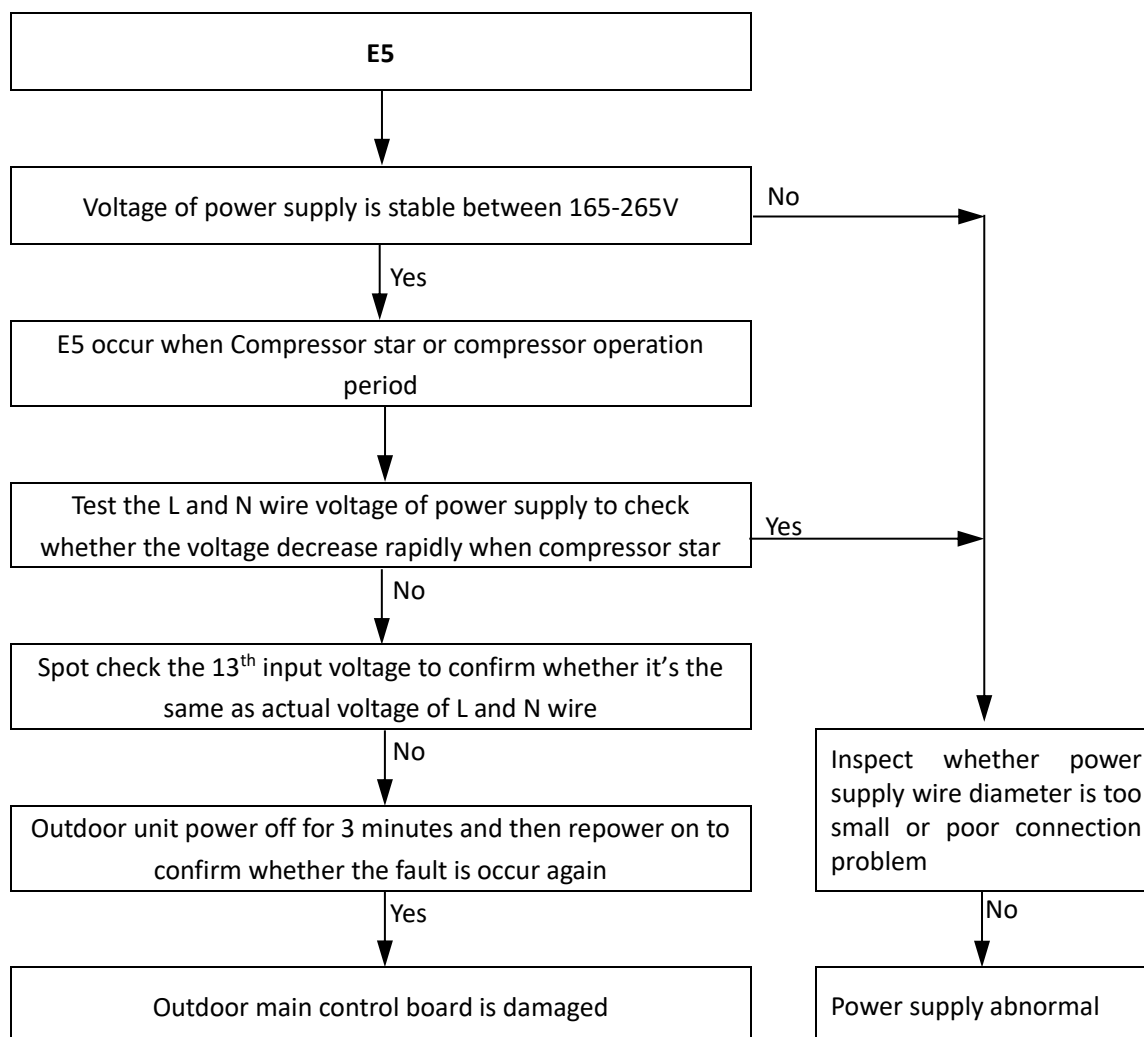

## 2.7 E6: DC fan motor error; Eb: E6 protection appears 6 times in one hour (For all models)

### 2.7.1 Digital display output

# E6 or Eb

### 2.7.2 Description

- E6:DC fan motor error; Eb: E6 protection appears 6 times in one hour
- The system stops running.
- Error code is displayed on the outdoor unit PCB.

### 2.7.3 Trigger / recover condition

- Trigger condition:  
For E6 protection: Main control board can't receive the fan speed feedback signal.  
For Eb protection: E6 protection appears 6 times in one hour.
- Recover condition: The fan speed feedback signal is normal.
- Reset method: For E6 protection, Resume automatically; For Eb protection, Manually restart.

### 2.7.4 Possible causes

- Loosened wiring within electric control box.
- DC fan motor damaged.
- Main PCB damaged.

### 2.7.5 Procedure

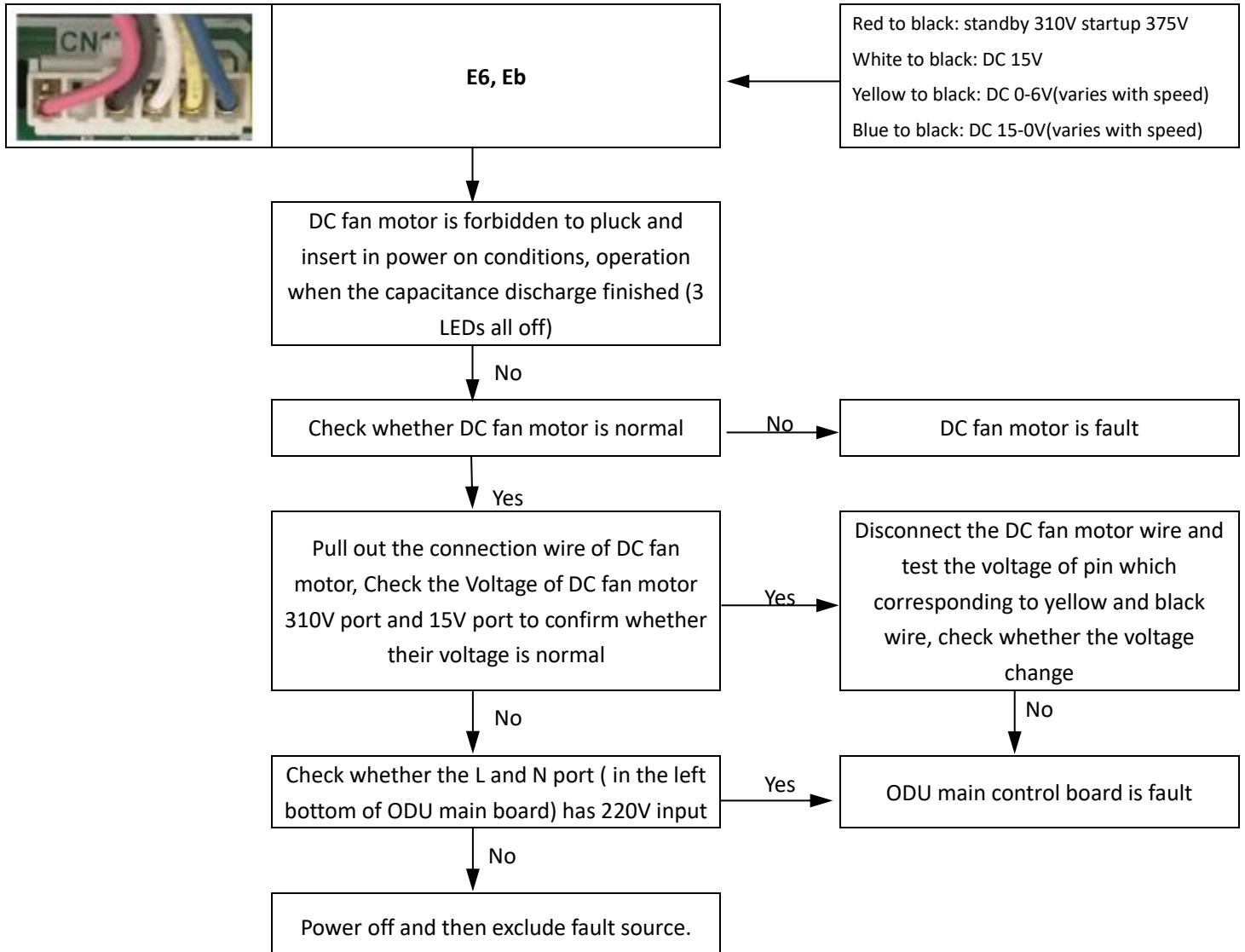

## 2.8 E9: EEPROM error (For all models)

### 2.8.1 Digital display output

# E9

### 2.8.2 Description

- EEPROM error
- The system stops running.
- Error code is displayed on the outdoor unit PCB.

### 2.8.3 Trigger / recover condition

- Trigger condition: Unable to read the EEPROM when startup.
- Recover condition: EEPROM goes back to normal.
- Reset method: Manually restart.

### 2.8.4 Possible causes

- The EEPROM is not inserted well
- Damaged main PCB.

### 2.8.5 Procedure

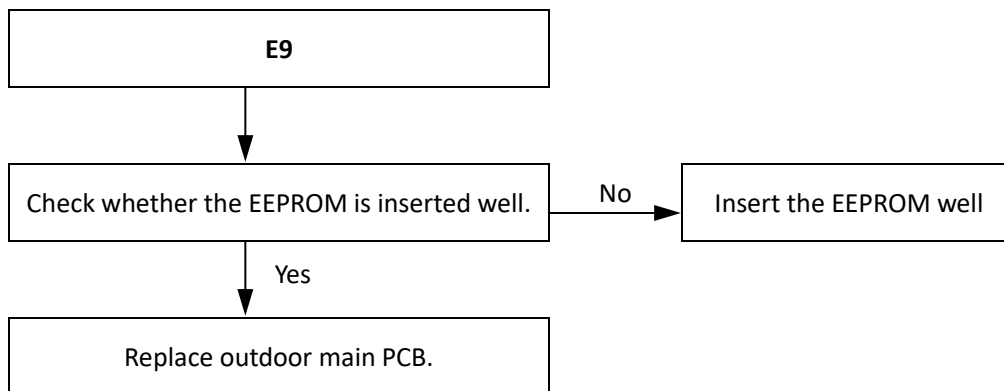

## 2.9 E.9.: Compressor parameters mismatch (For all models)

### 2.9.1 Digital display output

# E.9.

### 2.9.2 Description

- Main control chip detect the power setting number mismatch the model, the unit will display E.9. error.
- The system stops running.
- Error code is displayed on the outdoor unit PCB.

### 2.9.3 Trigger / recover condition

- Trigger condition: Main control chip detect the power setting number mismatch the model.
- Recover condition: Main control chip detect the power setting number match the model.
- Reset method: Manually restart.

### 2.9.4 Possible causes

- Power number setting mistake.
- Damaged main PCB.

### 2.9.5 Procedure

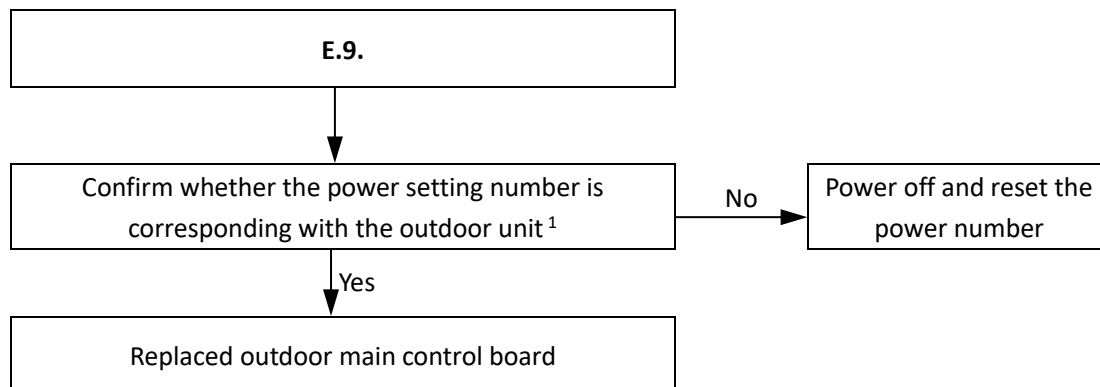

Notes:

1. Power setting switch is only for 36-56 model; 28 model don't need to setting

## 2.10 EF: PFC fault (For all models)

### 2.10.1 Digital display output

# EF

### 2.10.2 Description

- PFC fault protection.
- The system stops running.
- Error code is displayed on the outdoor unit PCB.

### 2.10.3 Trigger / recover condition

- Trigger condition: DC bus voltage is over 450V for continue 3 S or over 500V in the first 5 s in PFC star period.
- Recover condition: DC bus voltage is normal in the first 5 s in PFC star period.
- Reset method: Manually restart.

### 2.10.4 Possible causes

- DC fan motor damaged.
- Main PCB damaged.

### 2.10.5 Procedure

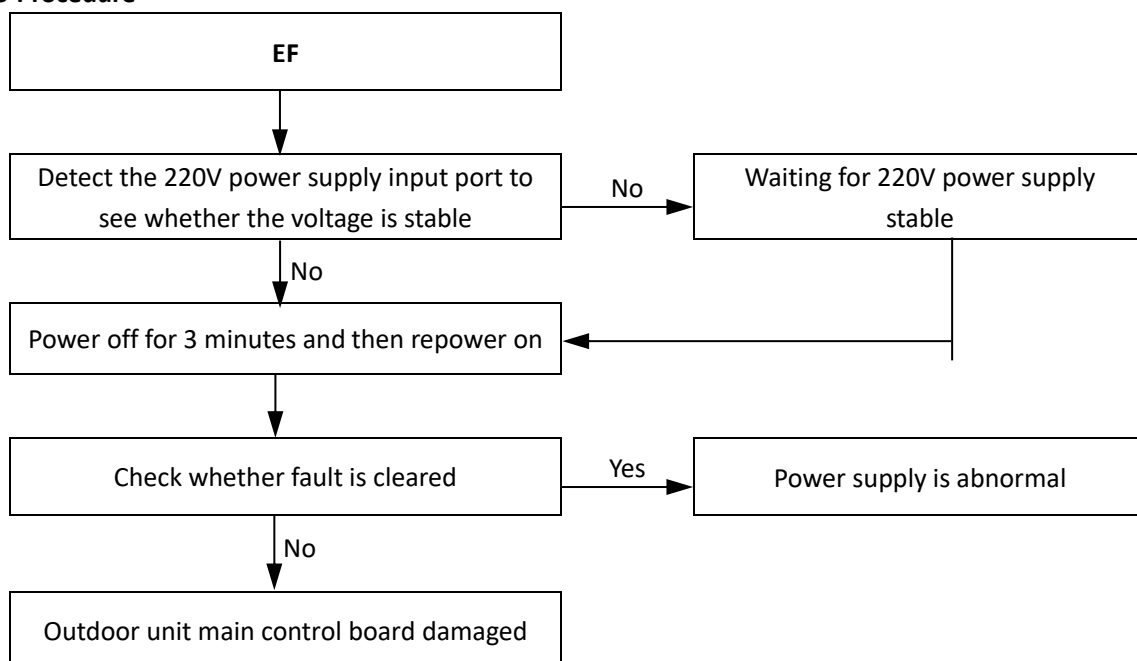

## 2.11 EH: Refrigerant radiator temperature sensor error (For all models)

### 2.11.1 Digital display output

# EH

#### 2.11.2 Description

- Refrigerant radiator temperature TL sensor error.
- The system stops running.
- Error code is displayed on outdoor unit PCB.

#### 2.11.3 Trigger / recover condition

- Trigger condition: TL temperature sensor is open circuited (or connector loose) or short circuited.
- Recover condition: The main control board can receive a normal feedback signal of TL sensor.
- Reset method: Resume automatically.

#### 2.11.4 Possible causes

- TL temperature sensor damaged.
- TL temperature sensor connect to the main control board is loose.
- Main PCB damaged.

#### 2.11.5 Procedure

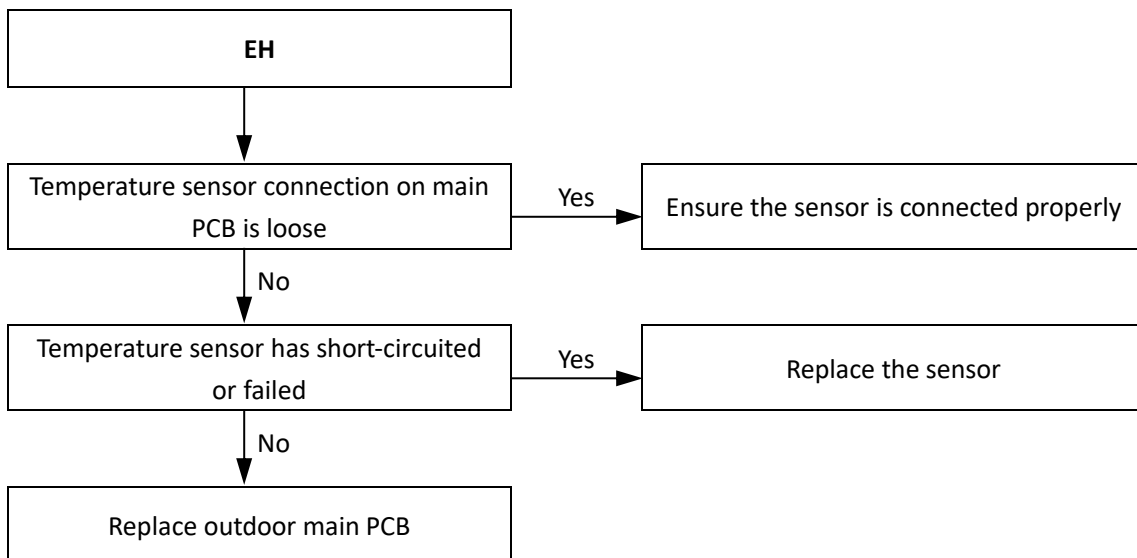

## 2.12 EP: Outdoor ambient temperature is lower than -15°C in cooling operation (For all models)

### 2.12.1 Digital display output

# EP

#### 2.12.2 Description

- Outdoor ambient temperature is lower than -15°C in cooling operation.
- The system stops running.
- Error code is displayed on outdoor unit PCB.

#### 2.12.3 Trigger / recover condition

- Trigger condition: Outdoor ambient temperature is lower than -15°C in cooling operation.
- Recover condition: Outdoor ambient temperature is over -15°C.
- Reset method: Resume automatically.

#### 2.12.4 Possible causes

- TL temperature sensor damaged.
- TL temperature sensor connect to the main control board is loose.
- Main PCB damaged.

#### 2.12.5 Procedure

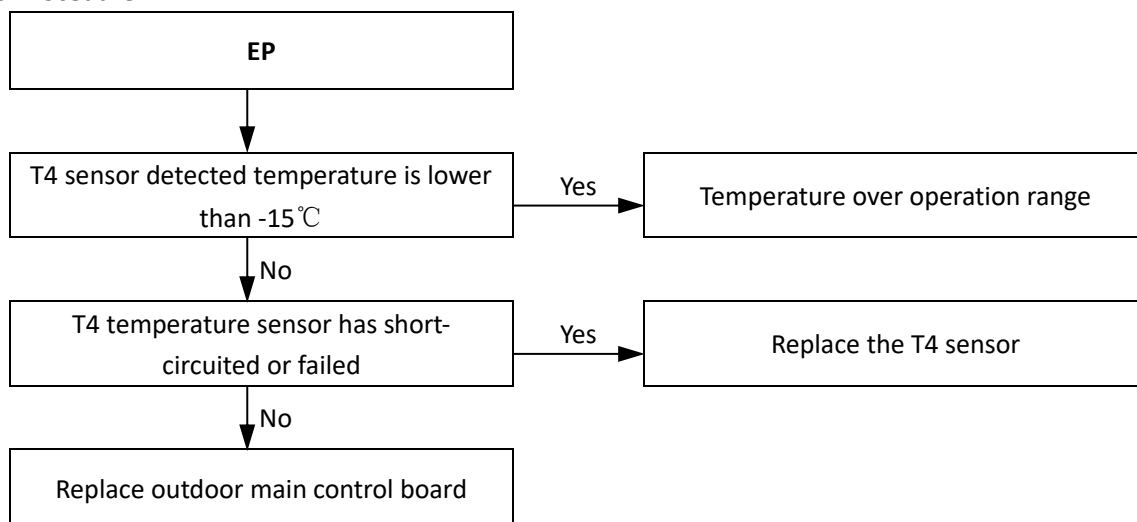

## 2.13 F1: DC bus voltage protection (for all models)

### 2.13.1 Digital display output

# F1

#### 2.13.2 Description

- F1 indicates DC bus voltage protection.
- The system stops running.
- Error code is displayed on the outdoor unit PCB.

#### 2.13.3 Trigger / recover condition

- Trigger condition: If IC55 main chip couldn't receive the DC bus voltage detection signal or the voltage less than 200VDC in the first 5 seconds period when power on, it would report F1 and the big relay is forbid to close.
- Recover condition: IC55 main chip can receive the DC bus voltage detection signal and the voltage over 200V DC.
- Reset method: Resume automatically.

#### 2.13.4 Possible causes

- DC fan motor damaged.
- The wire connect CN52 with CN53 is loose (36/42 model can ignore this reason for there's not this wire connection).
- Main control board damaged.
- Filter board damaged (36/42 model can ignore this reason for they don't have a filter board).

#### 2.13.5 Procedure

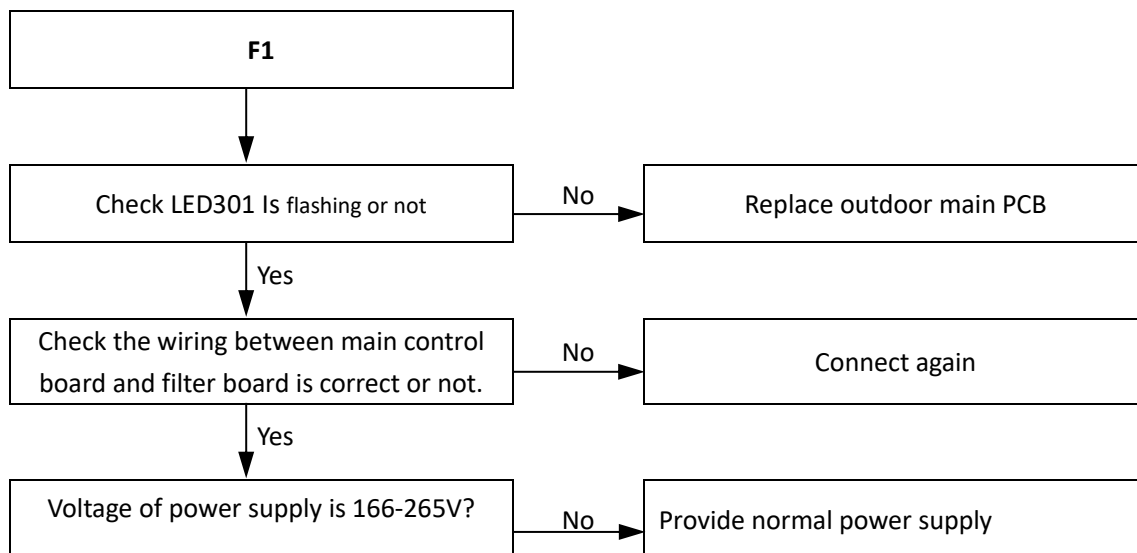



## 2.14 H4: L (L0/L1) fault occurs three times in one hour (For all models)

### 2.14.1 Digital display output

# H4

#### 2.14.2 Description

- The L (L0/L1) fault occurs three times in one hour.
- The system stops running.
- Error code is displayed on the unit with the error.

#### 2.14.3 Trigger / recover condition

- Trigger condition: The L (L0/L1) fault occurs three times in one hour.
- Recover condition: DC bus voltage goes back to normal.
- Reset method: Resume automatically.

#### 2.14.4 Possible causes

- DC bus voltage is too low.
- IPM Module has short circuit.
- Fan motor short circuit.
- Outdoor unit main control board damaged.

#### 2.14.5 Procedure

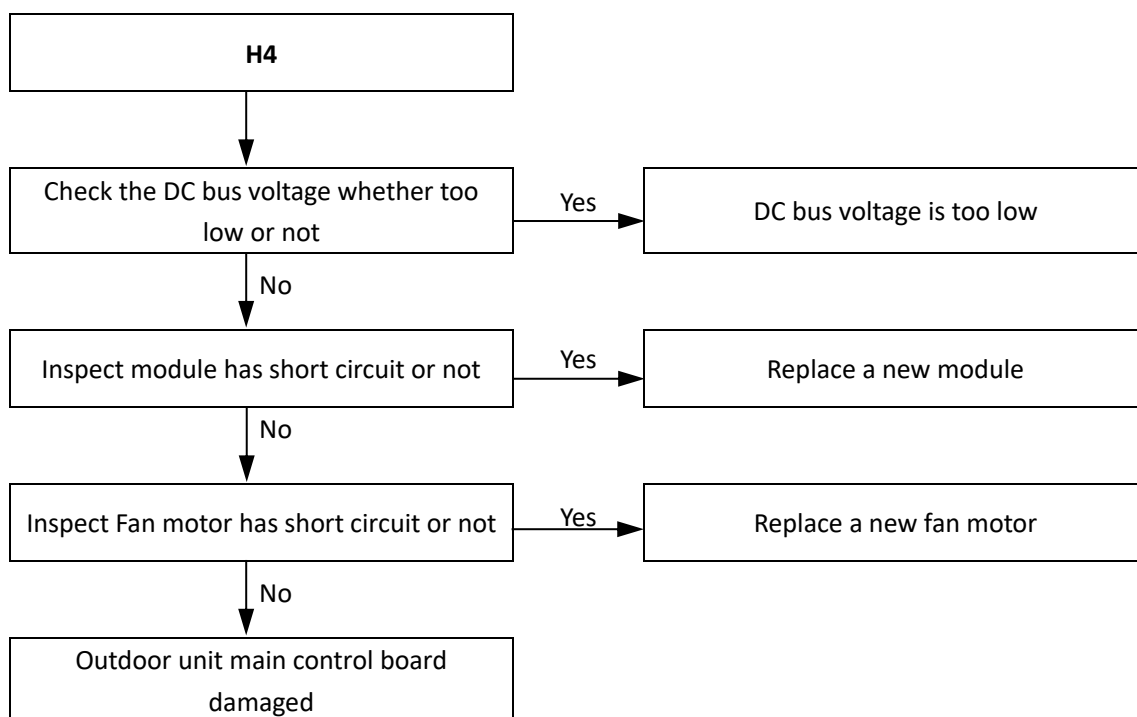

## 2.15 H7: The number of online indoor units have decreased/increased (For all models)

### 2.15.1 Digital display output

# H7

### 2.15.2 Description

- The number of online indoor units have decreased/increased.
- The system stops running.
- Error code is displayed on the unit with the error.

### 2.15.3 Trigger / recover condition

- Trigger condition: The number of online indoor units have decreased/increased.
- Recover condition: Number of indoor units detected is the same as first power on.
- Reset method: Resume automatically.

### 2.15.4 Possible causes

- Communication wire or power supply wire connection problem.
- Indoor unit main control board damaged.
- Outdoor unit main control board damaged.

### 2.15.5 Procedure

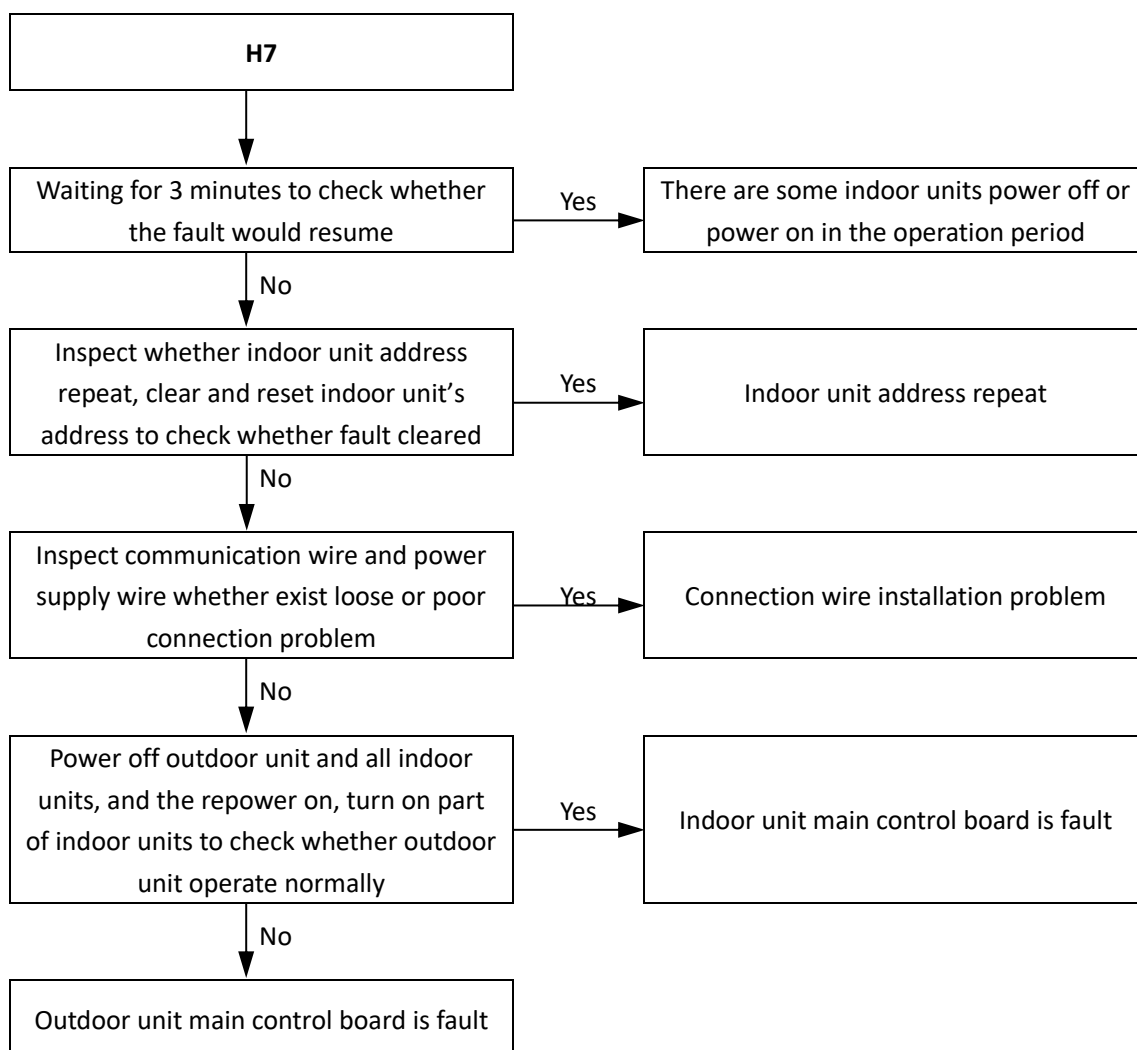

## 2.16 HF: Indoor unit and outdoor unit program mismatch (For all models)

### 2.16.1 Digital display output

# HF

#### 2.16.2 Description

- Indoor unit and outdoor unit program mismatch.
- The system stops running.
- Error code is displayed on the unit with the error.

#### 2.16.3 Trigger / recover condition

- Trigger condition: Indoor unit and outdoor unit program mismatch.
- Recover condition: Indoor unit and outdoor unit program match.
- Reset method: Resume automatically.

#### 2.16.4 Possible causes

- Indoor units and outdoor unit program mismatch.

#### 2.16.5 Procedure

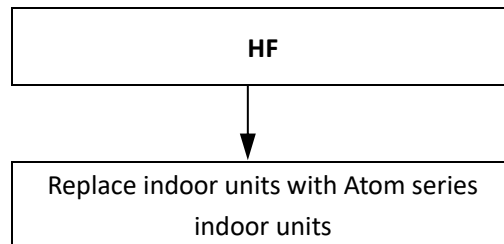

## 2.17 PL: Radiator surface high temperature protection (For all models)

### 2.17.1 Digital display output

# PL

#### 2.17.2 Description

- Radiator surface high temperature protection.
- The system stops running.
- Error code is displayed on outdoor unit PCB.

#### 2.17.3 Trigger / recover condition

- Trigger condition: Radiator surface temperature  $TF \geq 90^{\circ}\text{C}$ .
- Recover condition: Radiator surface temperature  $TF \leq 84^{\circ}\text{C}$ .
- Reset method: Resume automatically.

#### 2.17.4 Possible causes

- Refrigerant leakage/ Poor condenser heat exchange/ System blockage.
- The connection between refrigerant cooling tube and radiator is loose.
- Main PCB damaged.

#### 2.17.5 Procedure

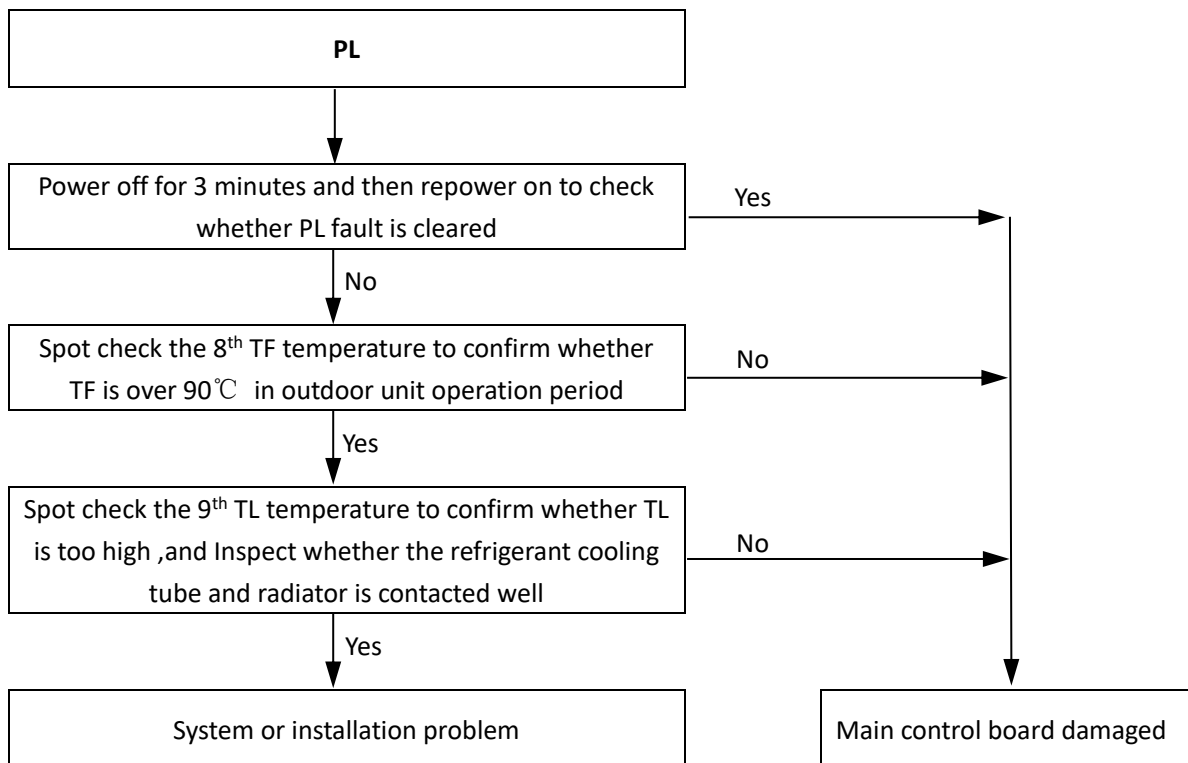

## 2.18 P1: Discharge pipe high pressure protection (For all models)

### 2.18.1 Digital display output

# P1

### 2.18.2 Description

- Discharge pipe high pressure protection.
- The system stops running.
- Error code is displayed on the outdoor unit PCB.

### 2.18.3 Trigger / recover condition

- Trigger condition: Discharge pressure  $\geq 4.4\text{MPa}$ .
- Recover condition: Discharge pressure  $\leq 3.2\text{MPa}$ .
- Reset method: Resume automatically.

### 2.18.4 Possible causes

- Pressure sensor/switch not connected properly or has malfunctioned.
- Excess refrigerant.
- System contains air or nitrogen.
- High pressure side blockage.
- Poor condenser heat exchange.
- Main PCB damaged.

## 2.18.5 Procedure

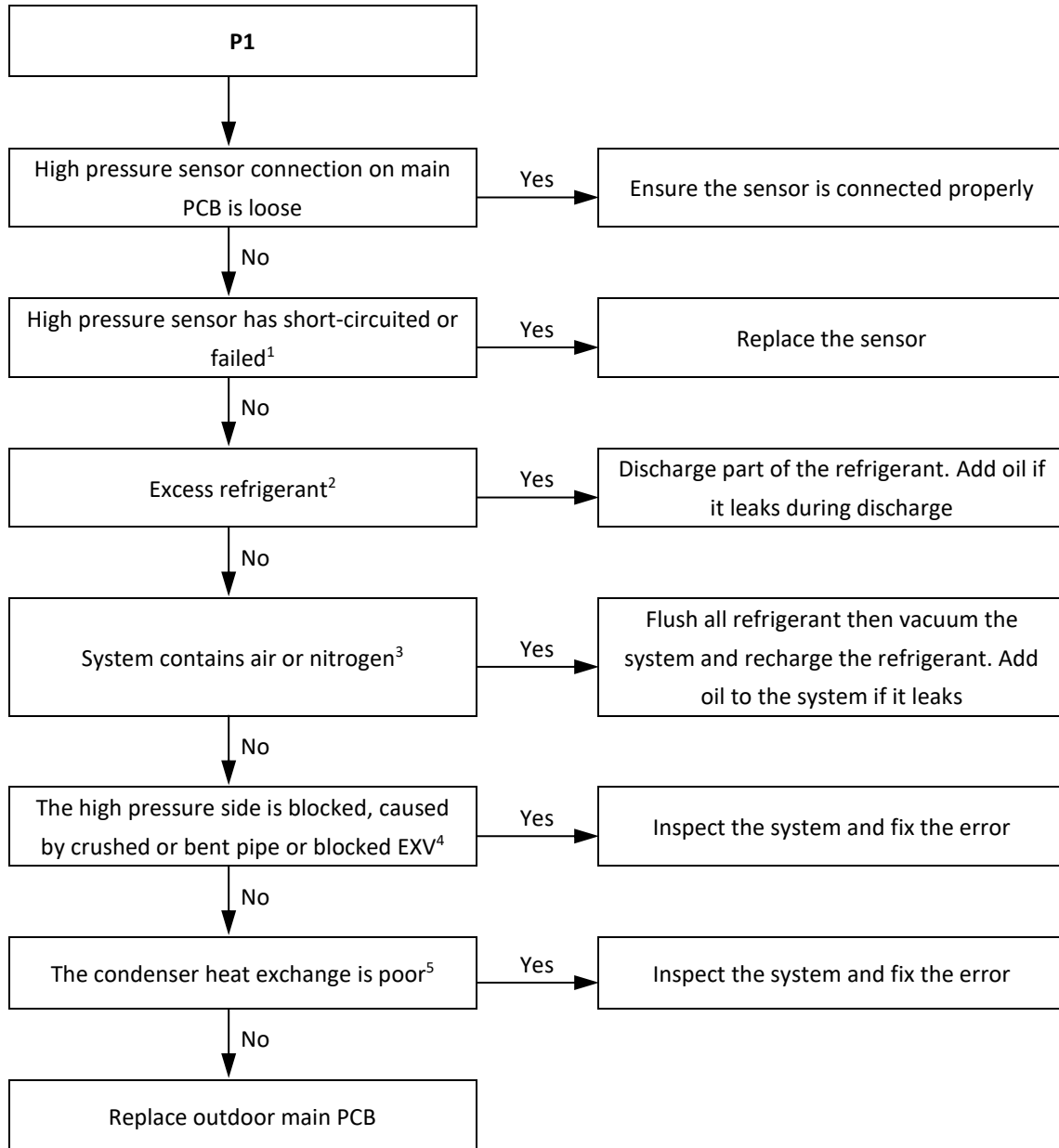

### Notes:

1. Measure the resistance among the three terminals of the pressure sensor. If the resistance is of the order of mega Ohms or infinite, the pressure sensor has failed.
2. Excess refrigerant causes discharge temperature to be lower than normal, discharge pressure to be higher than normal and suction pressure to be higher than normal.
3. Air or nitrogen in the system causes discharge temperature to be higher than normal, discharge pressure to be higher than normal, compressor current to be higher than normal, abnormal compressor noise and an unsteady pressure meter reading.
4. High pressure side blockage causes discharge temperature to be higher than normal, discharge pressure to be higher than normal and suction pressure to be lower than normal.
5. In cooling mode check outdoor heat exchangers, fans and air outlets for dirt/blockages. In heating mode check indoor heat exchangers, fans and air outlets for dirt/blockages.

## 2.19 P2: Suction pipe low pressure protection (For all models)

### 2.19.1 Digital display output

# P2

### 2.19.2 Description

- Suction pipe low pressure protection.
- The system stops running.
- Error code is displayed on outdoor unit PCB.

### 2.19.3 Trigger / recover condition

- Trigger condition: Suction pressure  $\leq 0.05\text{MPa}$ .
- Recover condition: Suction pressure  $\geq 0.15\text{MPa}$ .
- Reset method: Resume automatically.

### 2.19.4 Possible causes

- Insufficient refrigerant.
- Low pressure side blockage.
- Poor evaporator heat exchange.
- Main PCB damaged.

### 2.19.5 Procedure

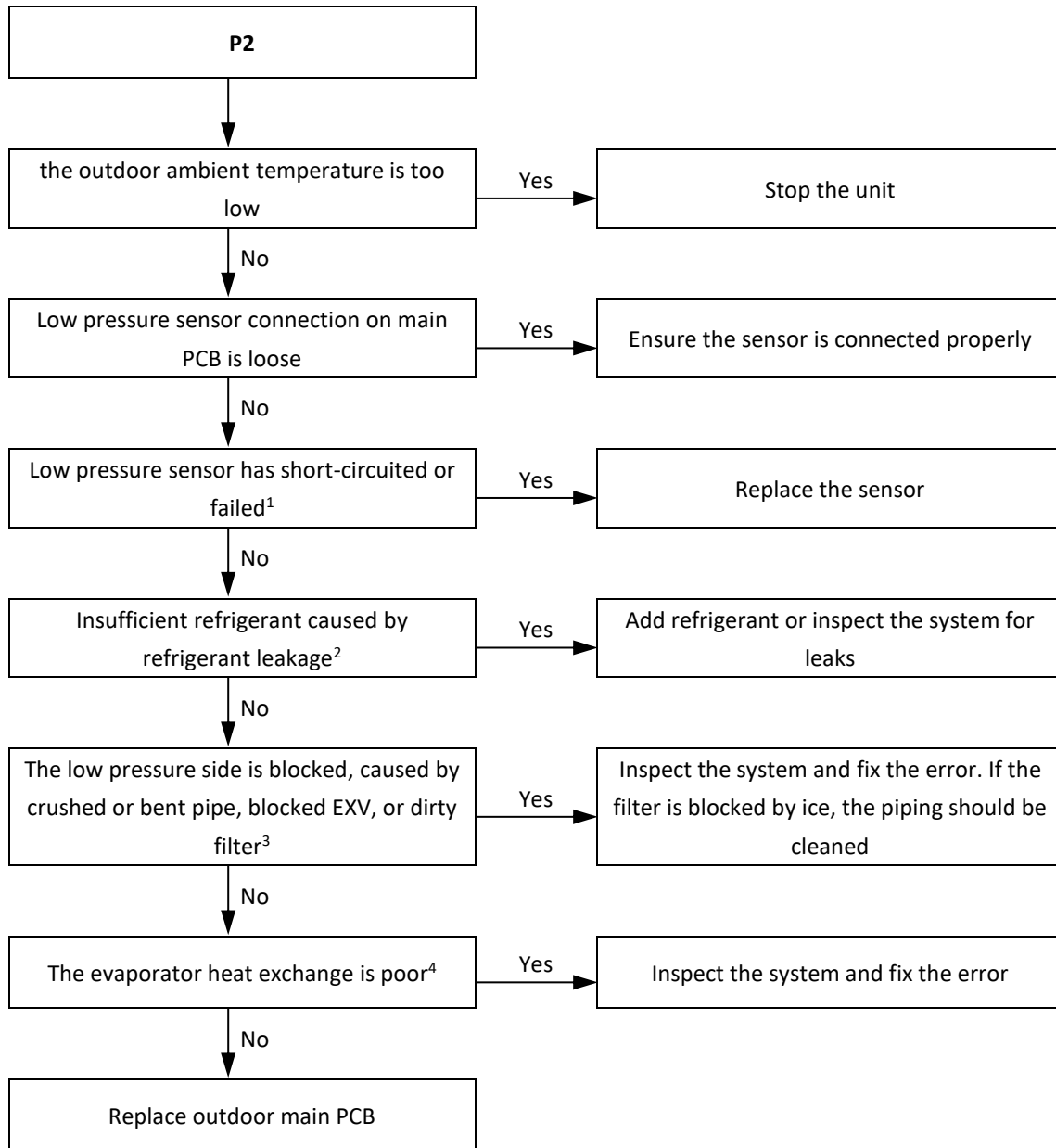

Notes:

1. Measure the resistance among the three terminals of the pressure sensor. If the resistance is of the order of mega Ohms or infinite, the pressure sensor has failed.
2. An insufficiency of refrigerant causes compressor discharge temperature to be higher than normal, discharge and suction pressures to be lower than normal and compressor current to be lower than normal, and may cause frosting to occur on the suction pipe. These issues disappear once sufficient refrigerant has been charged into the system.
3. A low pressure side blockage causes compressor discharge temperature to be higher than normal, suction pressure to be lower than normal and compressor current to be lower than normal, and may cause frosting to occur on the suction pipe.
4. In cooling mode check indoor heat exchangers, fans and air outlets for dirt/blockages. In heating mode check outdoor heat exchangers, fans and air outlets for dirt/blockages.



## 2.17 P3: Compressor current protection (For all models)

### 2.19.6 Digital display output

# P3

#### 2.19.7 Description

- P3 indicates current protection on compressor.
- The system stops running.
- Error code is displayed on the outdoor unit PCB.

#### 2.19.8 Trigger / recover condition

- Trigger condition: Current of compressor  $\geq C^1$ .
- Recover condition: Current of compressor  $< C^1$ .
- Reset method: Resume automatically.

Notes:

1. 28 model in cooling mode  $C=19A$ , 28 model in heating mode  $C=20A$ ; 36 model  $C=24A$ ; 42 model  $C=29A$ ; 48-52 model  $C=33A$ )

#### 2.19.9 Possible causes

- Indoor load too large.
- Power supply abnormal.
- Sudden interruption of power to IDUs.
- Excess refrigerant.
- System contains air or nitrogen.
- Poor condenser heat exchange.
- High pressure side blockage.
- Inverter module damaged.
- Compressor damaged.
- Main PCB damaged.

#### 2.19.10 Procedure

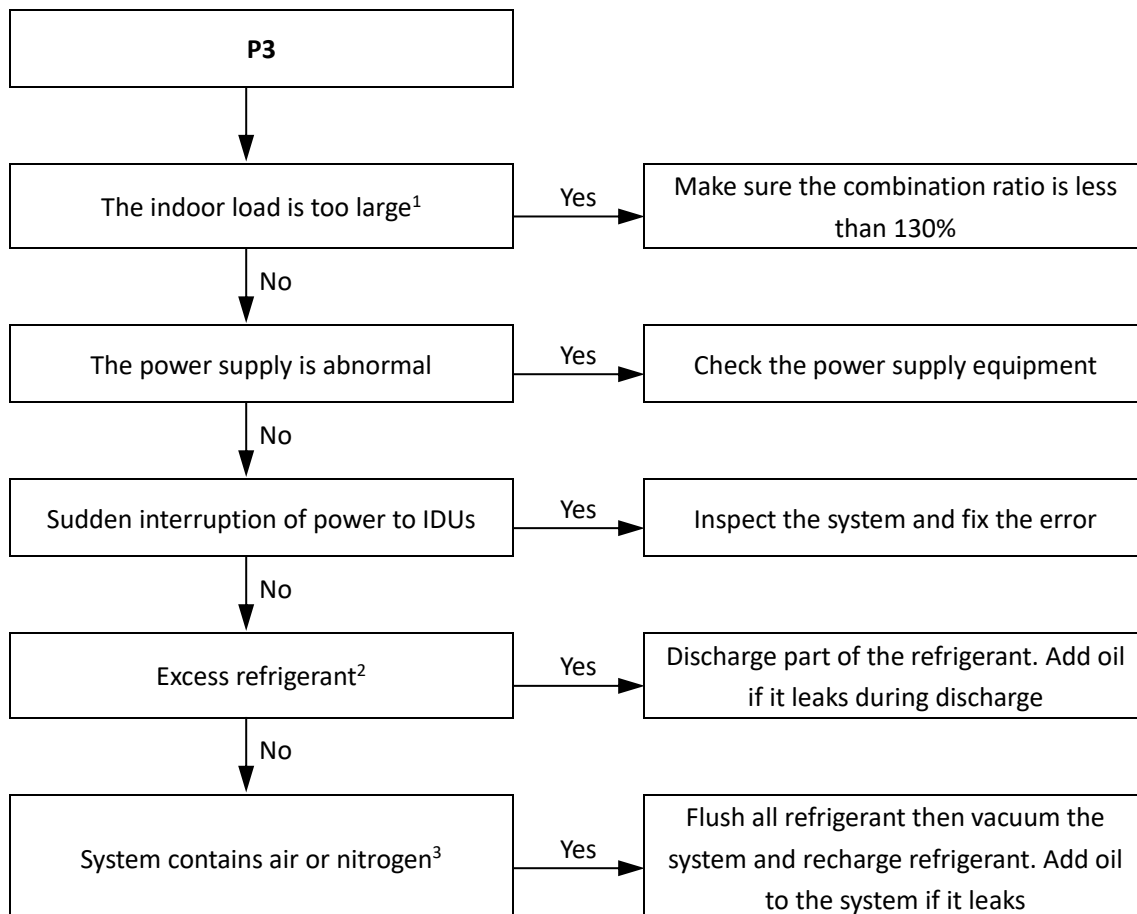

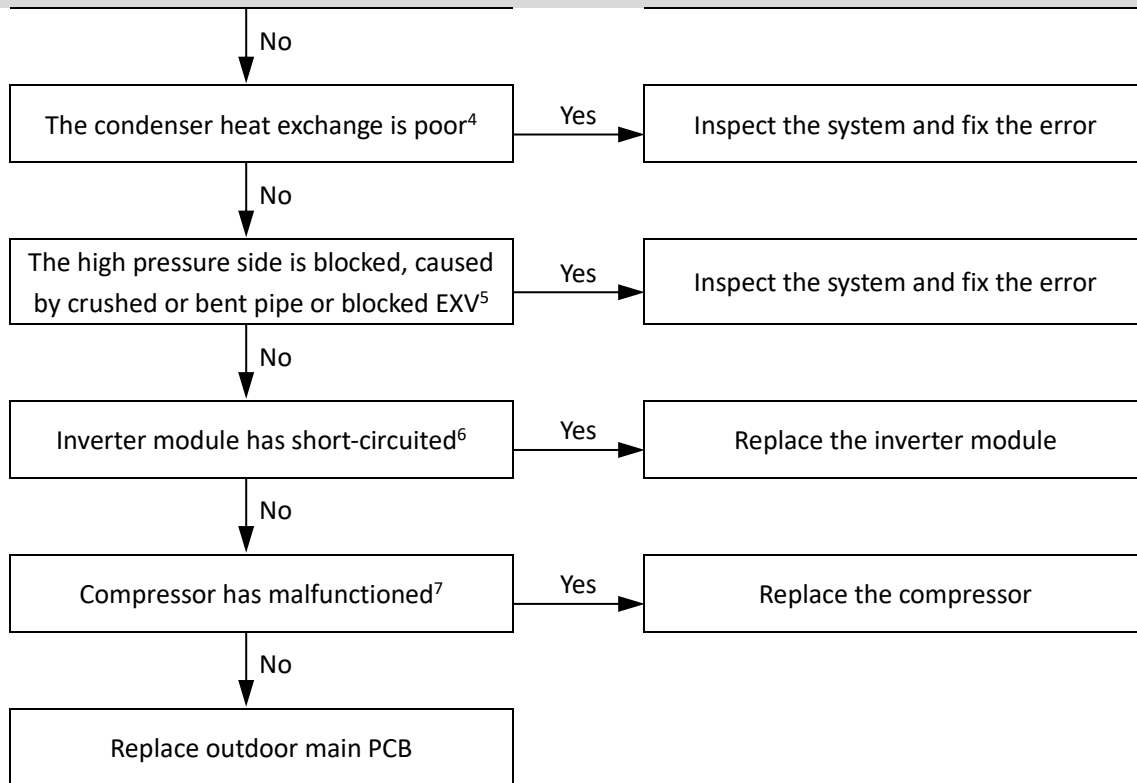

Notes:

1. An indoor load that is too large causes suction and discharge temperatures to be higher than normal.
2. Excess refrigerant causes discharge temperature to be lower than normal, discharge pressure to be higher than normal and suction pressure to be higher than normal.
3. Air or nitrogen in the system causes discharge temperature to be higher than normal, discharge pressure to be higher than normal, compressor current to be higher than normal, abnormal compressor noise and an unsteady pressure meter reading.
4. In cooling mode check outdoor heat exchangers, fans and air outlets for dirt/blockages. In heating mode check indoor heat exchangers, fans and air outlets for dirt/blockages.
5. High pressure side blockage causes discharge temperature to be higher than normal, discharge pressure to be higher than normal and suction pressure to be lower than normal.
6. Set a multi-meter to buzzer mode and test any two terminals of P N U V W of the inverter module. If the buzzer sounds, the inverter module has short-circuited.
7. The normal resistances of the inverter compressor are 0.5-1.5Ω among U V W and infinite between each of U V W and ground. If any of the resistances differ from these specifications, the compressor has malfunctioned.

## 2.18 P4: Discharge temperature protection (For all models)

### 2.18.1 Digital display output

# P4

### 2.18.2 Description

- Discharge temperature protection.
- The system stops running.
- Error code is displayed on the unit with the error.

### 2.18.3 Trigger / recover condition

- Trigger condition: Discharge temperature (T5) > 115°C.
- Recover condition: Discharge temperature (T5) < 90°C.
- Reset method: Resume automatically.

### 2.18.4 Possible causes

- Temperature sensor/switch not connected properly or has malfunctioned.
- Insufficient refrigerant.
- System blockage.
- Indoor load too large.
- System contains air or nitrogen.
- Poor condenser heat exchange.
- Main PCB damaged.

## 2.18.5 Procedure

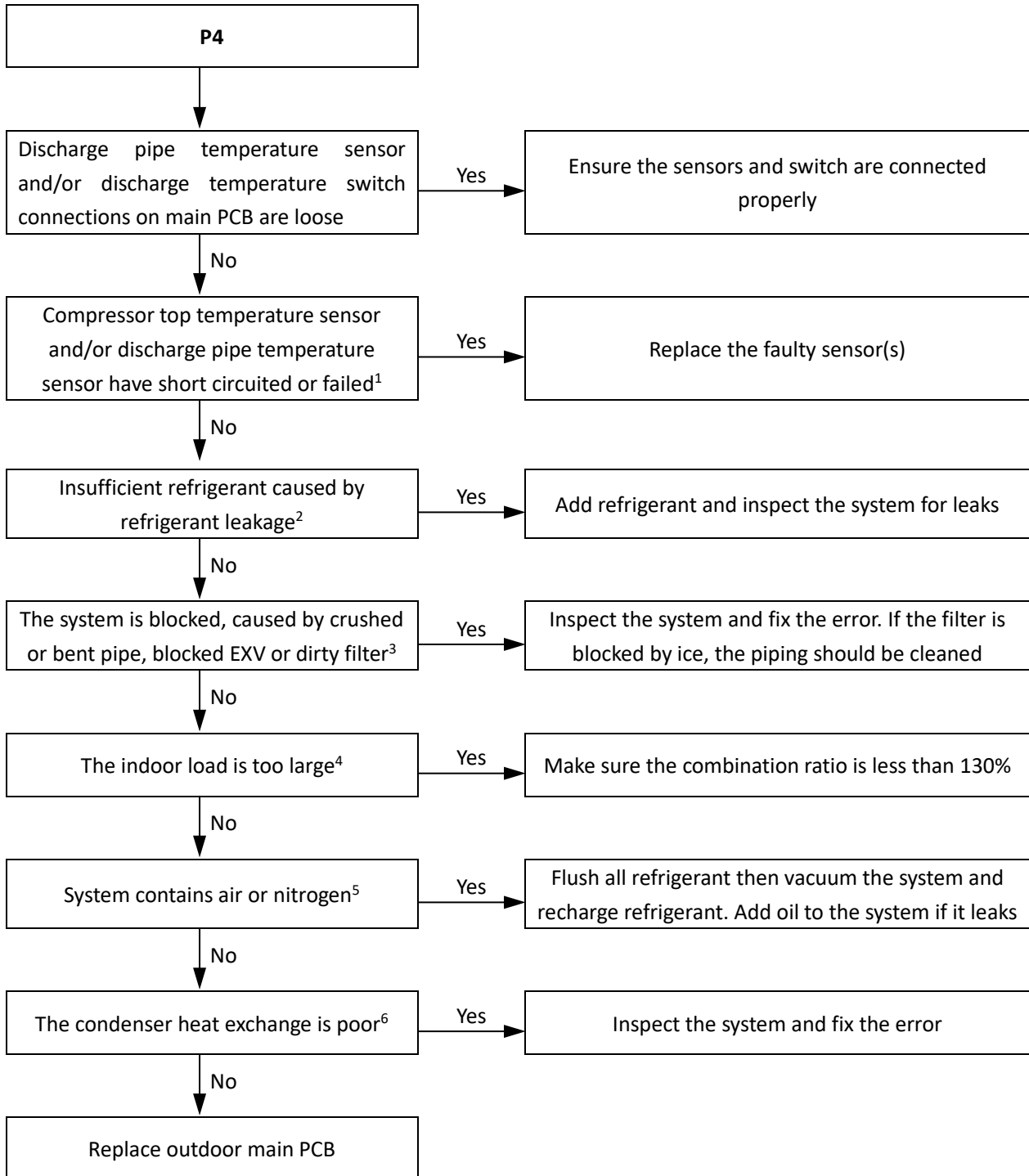

### Notes:

1. Measure sensor resistance. If the resistance is too low, the sensor has short-circuited. If the resistance is not consistent with the sensor's resistance characteristics table, the sensor has failed.
2. An insufficiency of refrigerant causes compressor discharge temperature to be higher than normal, discharge and suction pressures to be lower than normal and compressor current to be lower than normal, and may cause frosting to occur on the suction pipe. These issues disappear once sufficient refrigerant has been charged into the system.
3. A low pressure side blockage causes compressor discharge temperature to be higher than normal, suction pressure to be lower than normal and compressor current to be lower than normal, and may cause frosting to occur on the suction pipe.
4. An indoor load that is too large causes suction and discharge temperatures to be higher than normal.
5. Air or nitrogen in the system causes discharge temperature to be higher than normal, discharge pressure to be higher than normal, compressor current to be higher than normal, abnormal compressor noise and an unsteady pressure meter reading.
6. In cooling mode check outdoor heat exchangers, fans and air outlets for dirt/blockages. In heating mode check indoor heat exchangers, fans and air outlets for dirt/blockages.

## 2.19 P5: Outdoor heat exchanger temperature protection (For all models)

### 2.19.1 Digital display output

# P5

### 2.19.2 Description

- Outdoor heat exchanger temperature protection.
- The system stops running.
- Error code is displayed on the unit with the error.

### 2.19.3 Trigger / recover condition

- Trigger condition: Outdoor heat exchanger temperature (T3)  $\geq 62^{\circ}\text{C}$ .
- Recover condition: Outdoor heat exchanger temperature (T3)  $< 52^{\circ}\text{C}$ .
- Reset method: Resume automatically.

### 2.19.4 Possible causes

- Temperature sensor not connected properly or has malfunctioned.
- Indoor load too large.
- System contains air or nitrogen.
- Poor condenser heat exchange.
- High pressure side blockage.
- Main PCB damaged.

### 2.19.5 Procedure

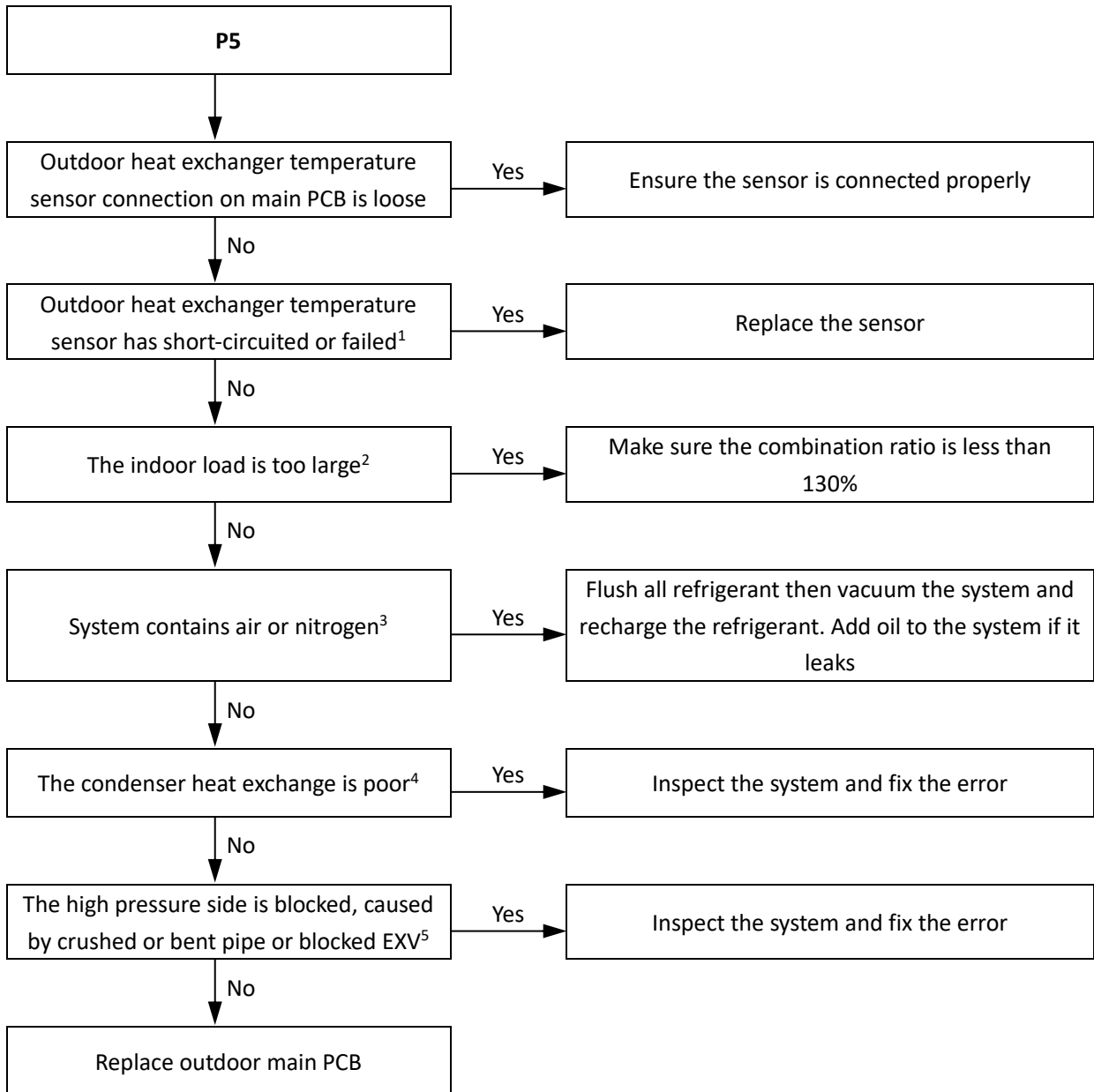

Notes:

1. Measure sensor resistance. If the resistance is too low, the sensor has short-circuited. If the resistance is not consistent with the sensor's resistance characteristics table, the sensor has failed.
2. An indoor load that is too large causes suction and discharge temperatures to be higher than normal.
3. Air or nitrogen in the system causes discharge temperature to be higher than normal, discharge pressure to be higher than normal, compressor current to be higher than normal, abnormal compressor noise and an unsteady pressure meter reading.
4. In cooling mode check outdoor heat exchangers, fans and air outlets for dirt/blockages. In heating mode check indoor heat exchangers, fans and air outlets for dirt/blockages.
5. High pressure side blockage causes discharge temperature to be higher than normal, discharge pressure to be higher than normal and suction pressure to be lower than normal.

## 2.20 P8: Typhoon protection (For all models)

### 2.20.1 Digital display output

# P8

#### 2.20.2 Description

- P8 indicates strong wind protection.
- The system stops running.
- Error code is displayed on the outdoor unit PCB.

#### 2.20.3 Trigger / recover condition

- Trigger condition:  
Fan speed  $\geq 400$ rps when the outdoor unit is not start up. Or fan speed over 400rps for 90S when outdoor unit stop for malfunction.
- Recover condition: Detect the fan speed  $< 400$ rps for more than 120S.
- Reset method: Resume automatically.

#### 2.20.4 Possible causes

- There is strong wind around the outdoor unit.
- DC fan motor is damaged.
- Main PCB damaged.

#### 2.20.5 Procedure

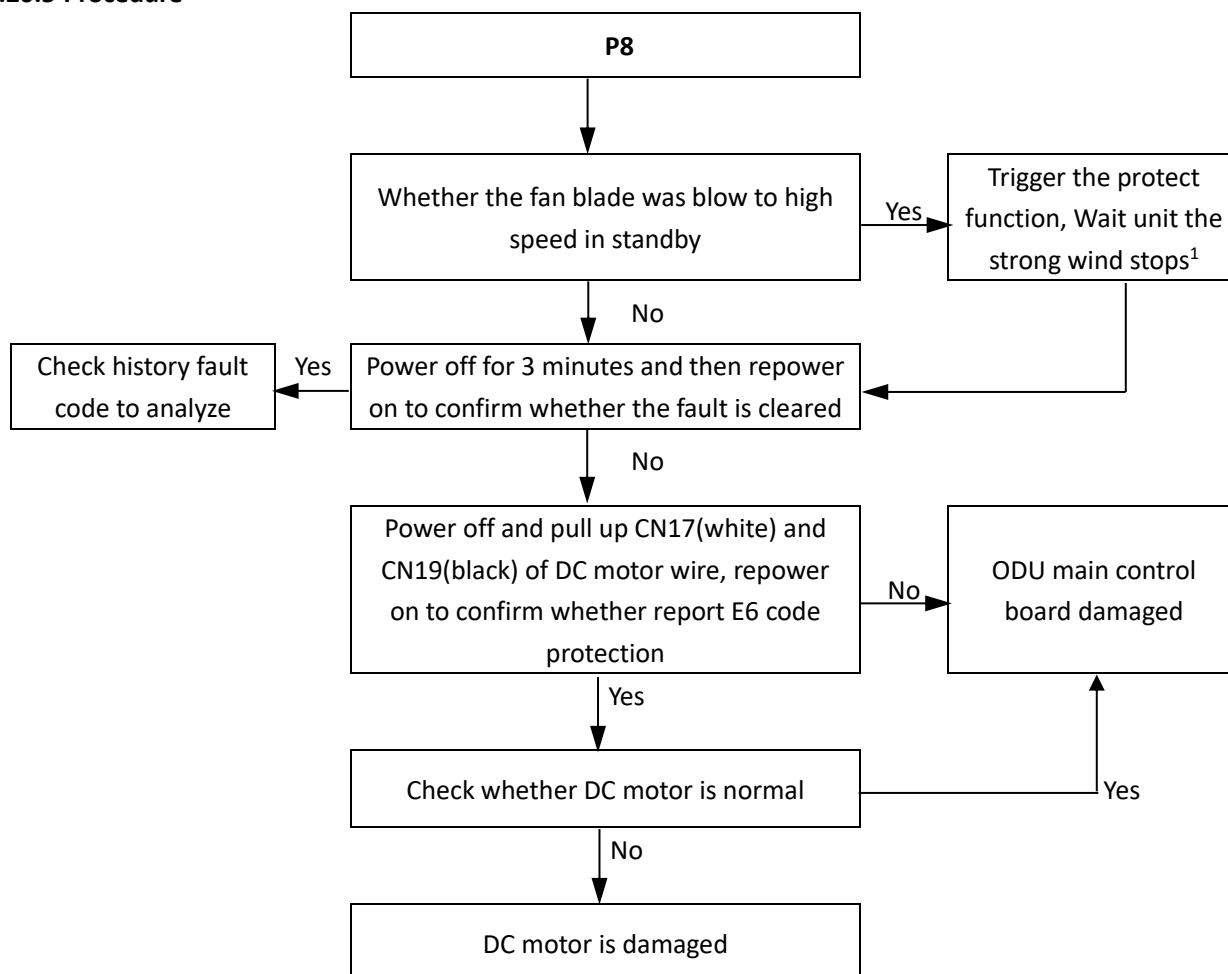

Notes:

1. P8 protection recovers in 2 minutes when the strong wind stops.

## 2.21 P9: Poor reversing of four-way valve (For all models)

### 2.21.1 Digital display output

# P9

#### 2.21.2 Description

- P9 indicates poor reversing of four-way valve.
- The system stops running.
- Error code is displayed on the outdoor unit PCB.

#### 2.21.3 Trigger / recover condition

- Trigger condition: Poor reversing of four-way valve.
- Recover condition: Four-way valve recover to normal .
- Reset method: Resume automatically.

#### 2.21.4 Possible causes

- Four-way valve is damaged.
- Main PCB damaged.

#### 2.21.5 Procedure

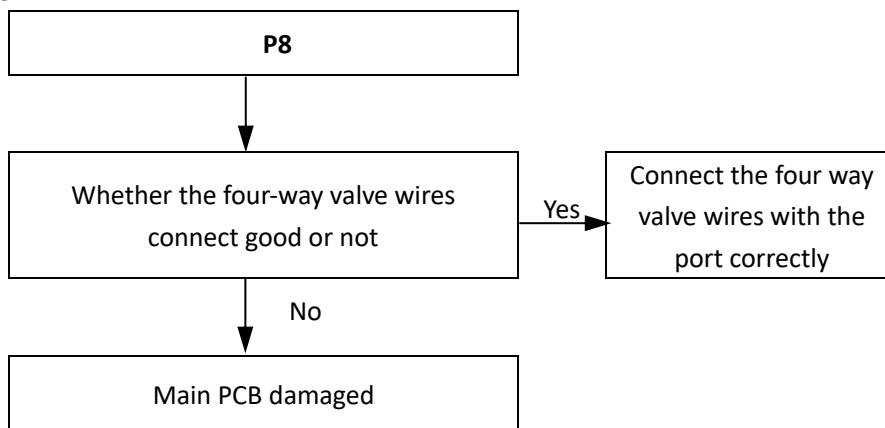



## 2.22 PE: Evaporator high temperature protection (For all models)

### 2.22.1 Digital display output

# PE

#### 2.22.2 Description

- Evaporator high temperature protection
- The system stops running.
- Error code is displayed on the outdoor unit PCB.

#### 2.22.3 Trigger / recover condition

- Trigger condition:  
The middle average temperature of the evaporator is higher than 63°C for 50 seconds
- Recover condition: Pipe temperature < 50°C.
- Reset method: Resume automatically.

#### 2.22.4 Possible causes

- Indoor temperature is too high.
- Temperature sensor not connected properly or has malfunctioned.
- System blockage.
- Poor condenser heat exchange.
- Indoor unit Main PCB damaged

#### 2.22.5 Procedure

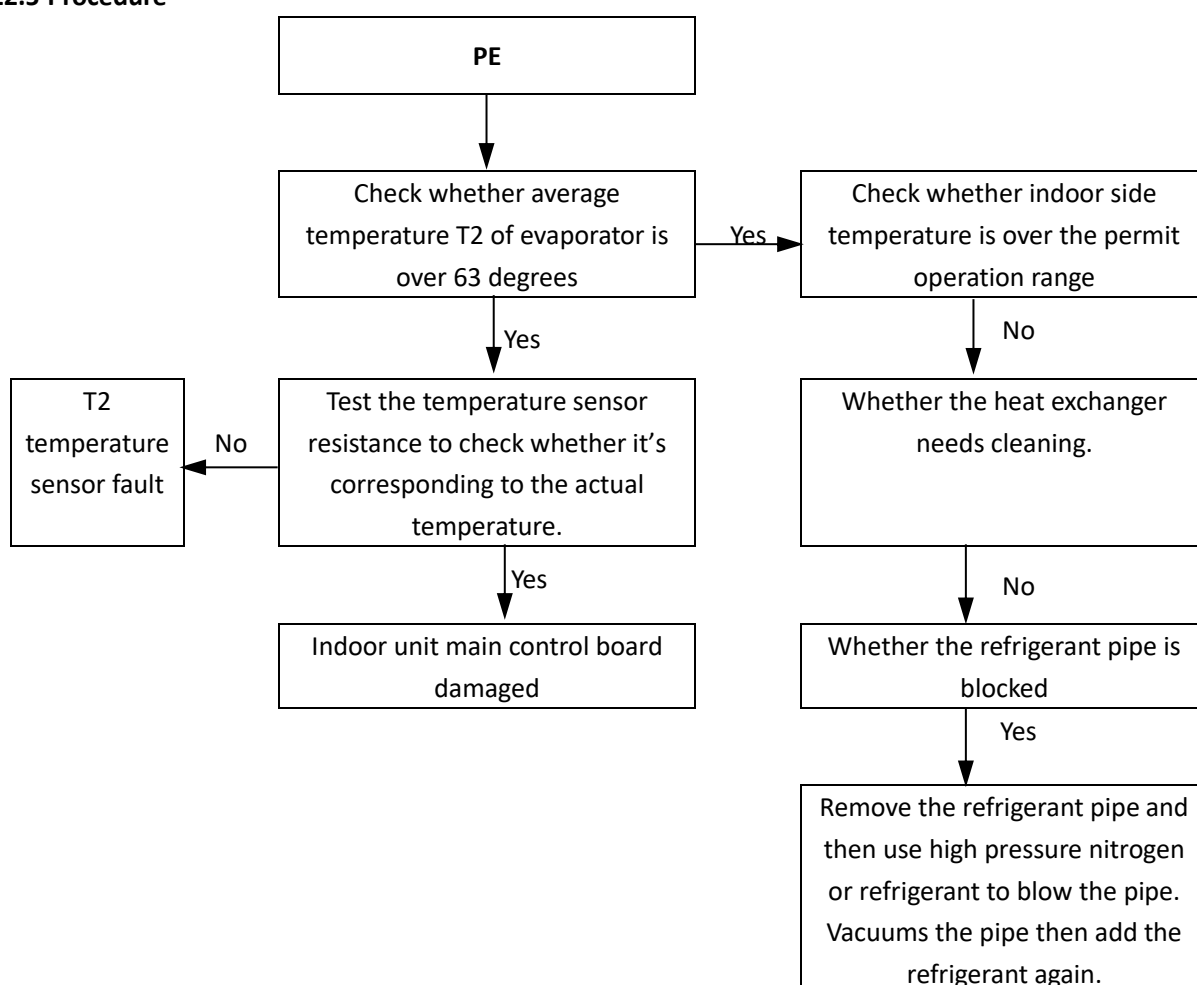

## 2.23 L0/L1/L2/L4/L5/L7/L8/L9: L category of inverter module protection (For all models)

### 2.23.1 Digital display output

# L0/L1/L2/L4/L5/L7/L8/L9

### 2.23.2 Description

- Compressor inverter module protection.
- The system stops running.
- Error code is displayed on the outdoor unit PCB.

### 2.23.3 Trigger / recover condition

- Trigger condition: Inverter module or compressor is abnormal.
- Recover condition: Inverter module and compressor goes back to normal.
- Reset method: Manually restart.

### 2.23.4 Possible causes

- Power supply is abnormal.
- Refrigerant cooling module is abnormal.
- Compressor is abnormal.
- Outdoor unit main control board damaged.

### 2.23.5 L0/L4: Procedure

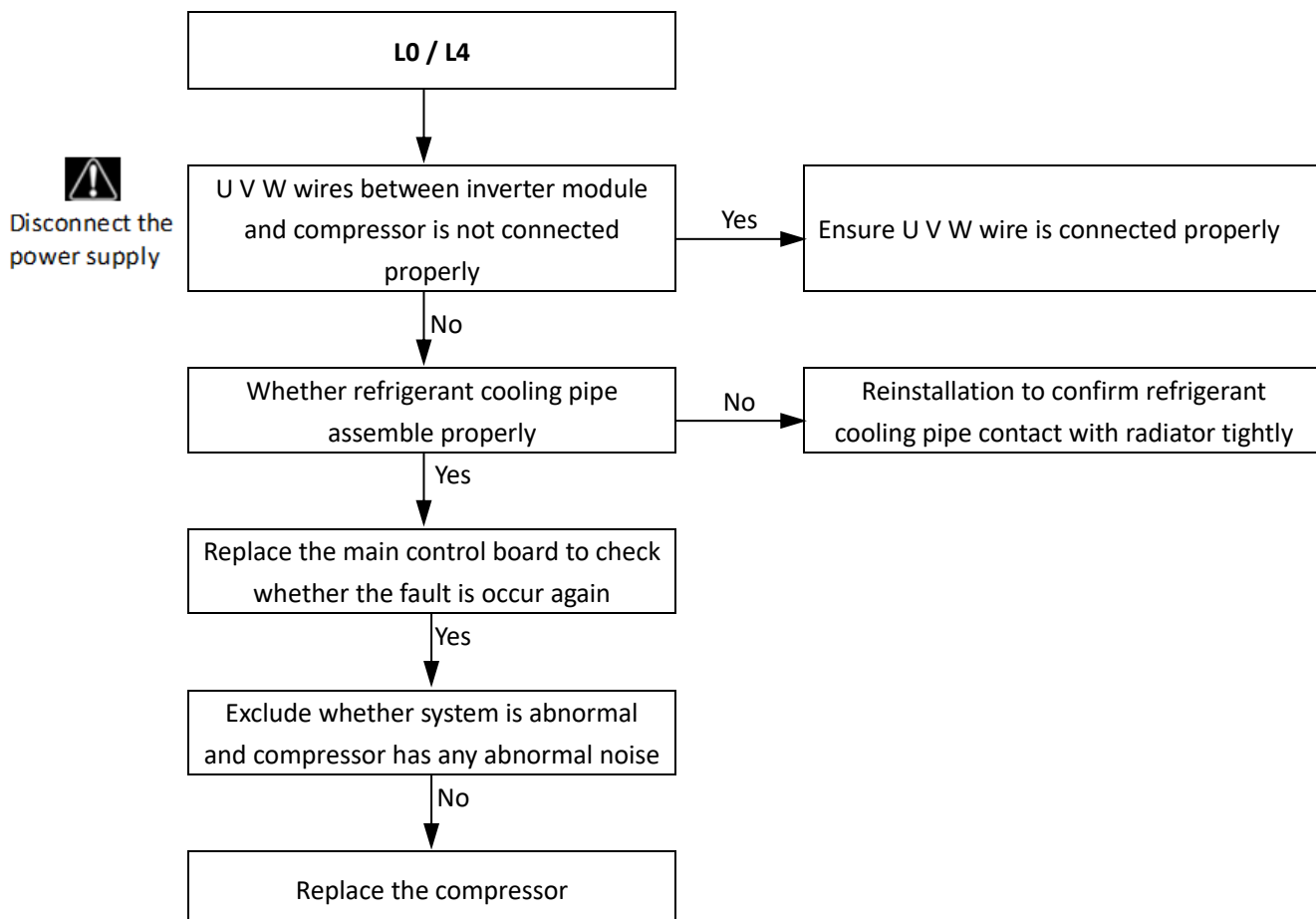

### 2.23.6 L5: Zero speed protection

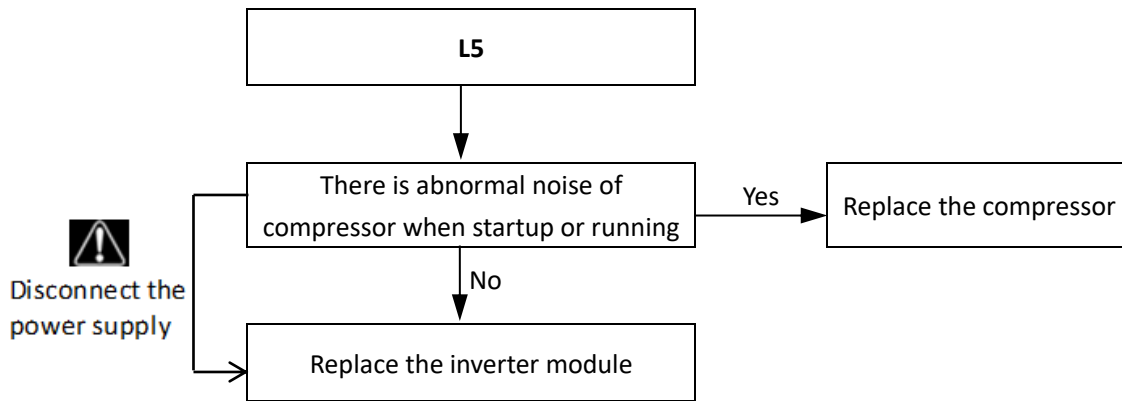

### 2.23.7 L7: Phase sequence error

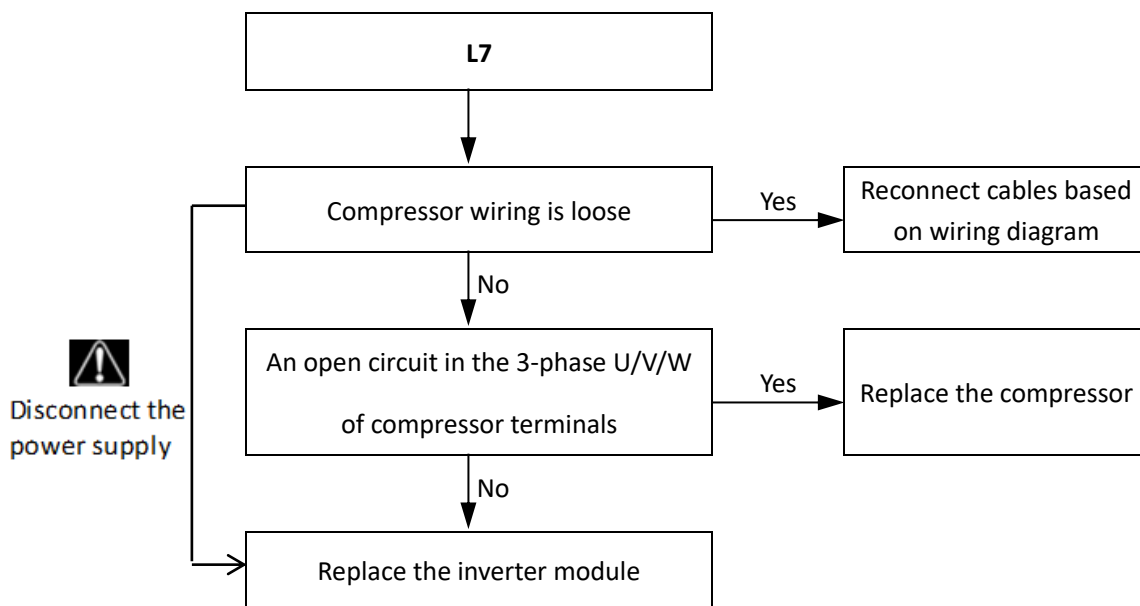

### 2.23.8 L8 / L9 troubleshooting

 Disconnect the power supply

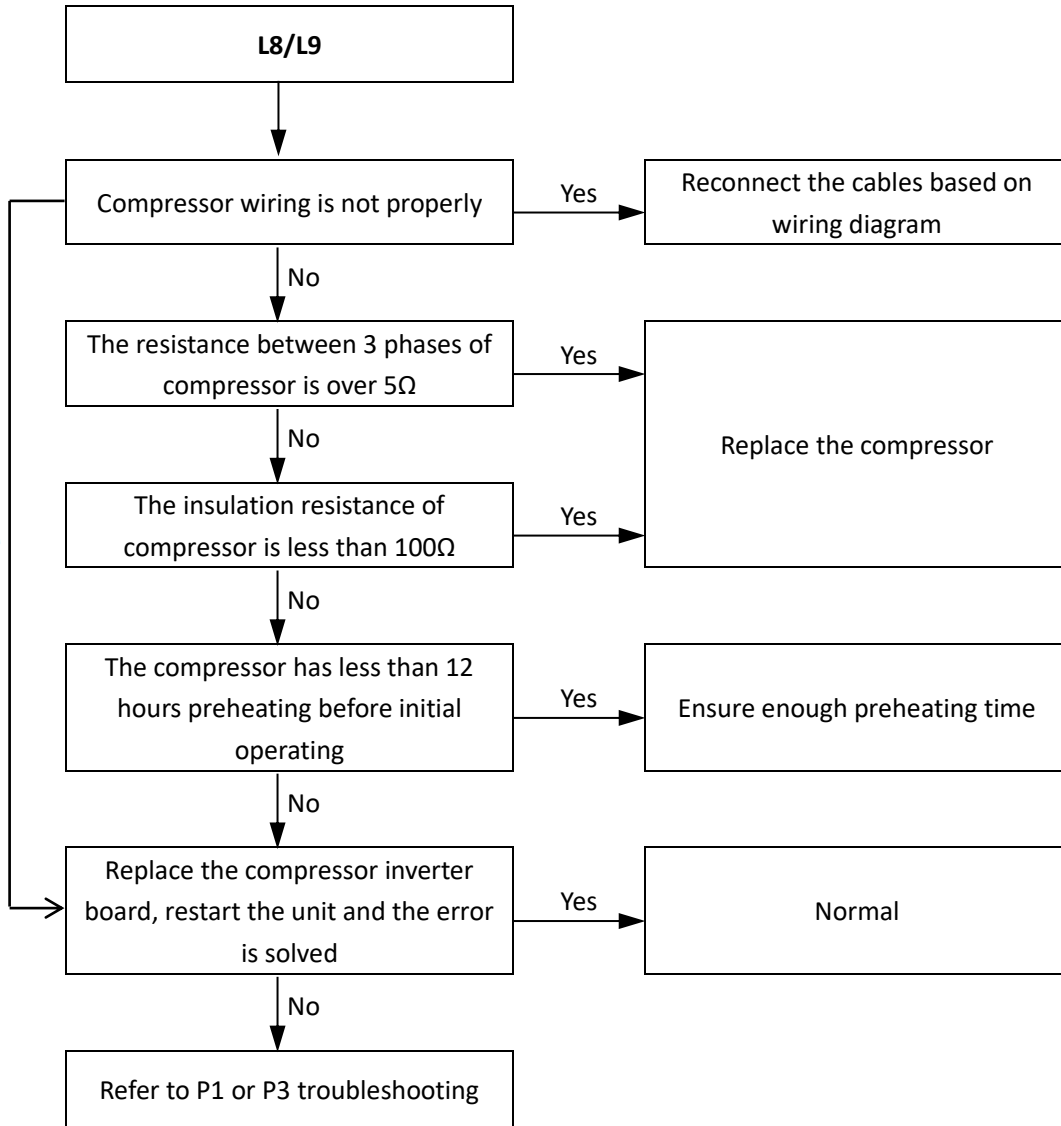

**2.23.9 L1: DC bus low voltage protection**

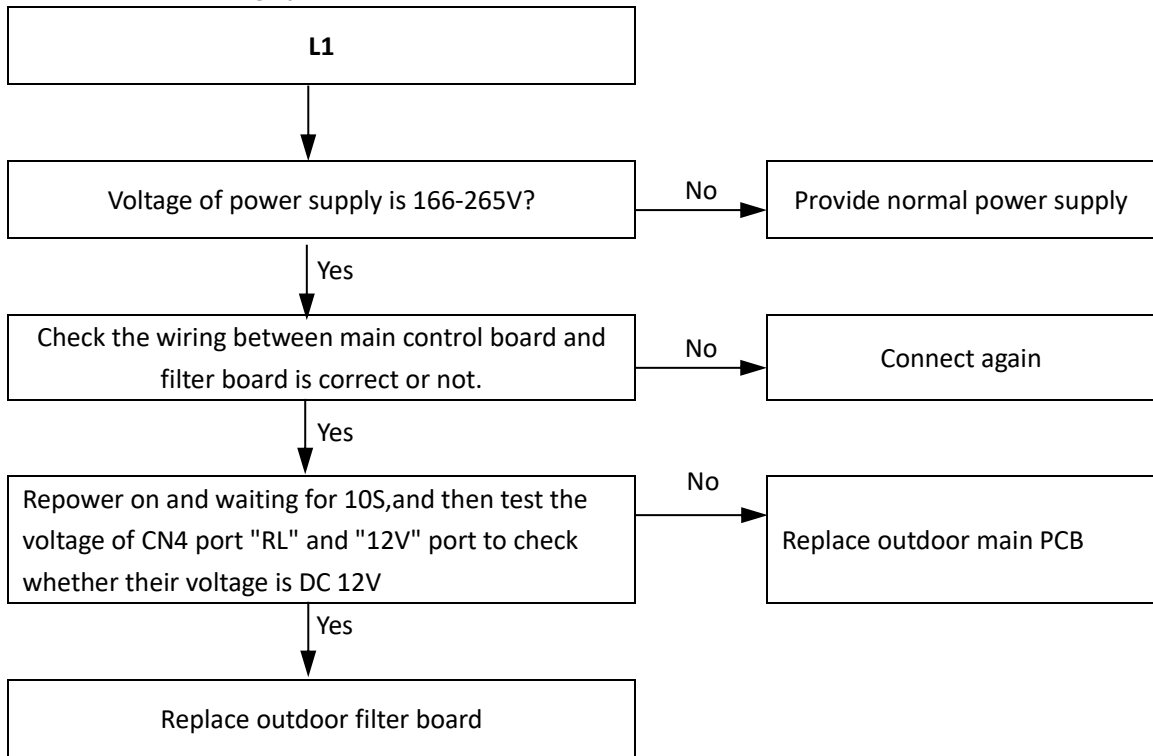

**2.23.10 L2: DC bus high voltage protection**

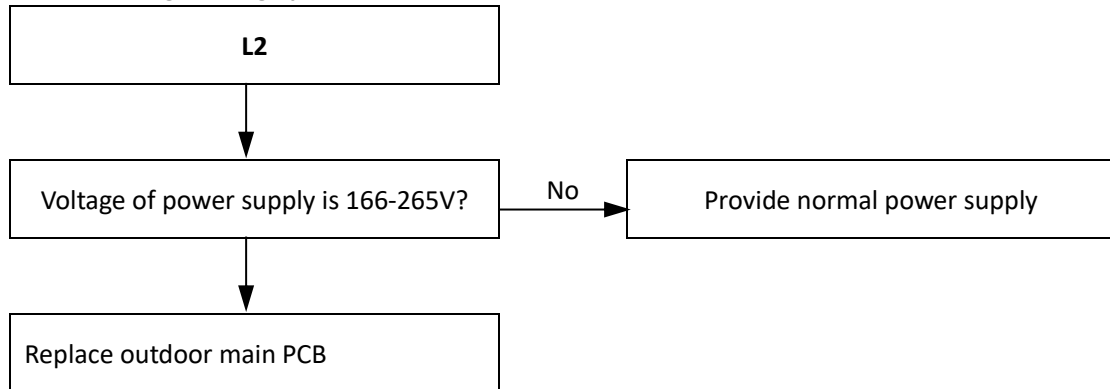

### 2.23.11 Compressor replacement procedure

#### Step 1: Remove faulty compressor and remove oil

- Remove the faulty compressor from the outdoor unit.
- Before removing the oil, shake the compressor so as to not allow impurities to remain settled at the bottom.
- Drain the oil out of the compressor and retain it for inspection. Normally the oil can be drained out from the compressor discharge pipe.

#### Step 2: Inspect oil from faulty compressor

- The oil should be clear and transparent. Slightly yellow oil is not an indication of any problems. However, if the oil is dark, black or contains impurities, the system has problems and the oil needs to be changed. Refer to Figure 6-2.7 for further details regarding inspecting compressor oil. (If the compressor oil has been spoiled, the compressor will not be being lubricated effectively. The scroll plate, crankshaft and bearings will wear. Abrasion will lead to a larger load and higher current. More electric energy will get dissipated as heat and the temperature of the motor will become increasingly high. Finally, compressor damage or burnout will result.)

#### Step 3: Check oil in other compressors in the system

- If the oil drained from the faulty compressor is clean, go to Step 6.
- If the oil drained from the faulty compressor is spoiled (lightly or heavily), go to Step 4.

#### Step 4: Replace oil separator and accumulator

- If the oil from a compressor is spoiled (lightly or heavily), drain the oil from the oil separator and accumulator in that unit and then replace them.

#### Step 5: Check filters(s)

- If the oil from a compressor is spoiled (lightly or heavily), check the filter between the gas stop valve and the 4-way valve in that unit. If it is blocked, clean with nitrogen or replace.

#### Step 6: Replace the faulty compressor and re-fit the other compressors

- Replace the faulty compressor.
- If the oil had been spoiled and was drained from the non-faulty compressor in Step 3, use clean oil to clean them before re-fitting it into the unit. To clean, add oil into the compressor through the discharge pipe using a funnel, shake the compressor, and then drain the oil. Repeat several times and then re-fit the compressors into the units. (The discharge pipe is connected to the oil pool of the compressor by the inner oil balance pipe.)

#### Step 7: Add compressor oil

- Add oil to each of the compressors from which oil was drained in Step 3.
- Only use RB75EA oil. Different compressors require different types of oil. Using the wrong type of oil leads to various problems.
- Add oil to the accumulator from which oil was drained in Step 4.

#### Step 8: Vacuum drying and refrigerant charging

- Once all the compressors and other components have been fully connected, vacuum dry the system and recharge refrigerant.

Figure 6-2.6: Compressor piping



### 2.23.12 Specific error codes for inverter module protection

The specific error codes L0, L1, L2, L4, L5, L7, L8 and L9 can also be obtained from the inverter module LED indicators. If an inverter module error has occurred, one of inverter module LED indicators is continuously on and the other one of inverter module LED indicators flashes

Table 6-2.3: Errors indicated on LED

LED flashing pattern	Corresponding error
Flashes 4 times and stops for 1 second, then repeats	Communication malfunction between IR341/main board
Flashes 8 times and stops for 1 second, then repeats	L0 - Inverter module protection
Flashes 9 times and stops for 1 second, then repeats	L1 - DC bus low voltage protection
Flashes 10 times and stops for 1 second, then repeats	L2 - DC bus high voltage protection
Flashes 12 times and stops for 1 second, then repeats	L4 - MCE error
Flashes 13 times and stops for 1 second, then repeats	L5 - Zero speed protection
Flashes 15 times and stops for 1 second, then repeats	L7 - Phase sequence error



**OMEGA**  
ENVIRONMENTAL  
TECHNOLOGIES LLC.

17702 Mitchell North, #101  
Irvine, CA. 92614 .USA  
Tel: 714 795 2830  
Fax: 714 966 1646  
info@omegainverter.com  
www.omegainverter.com

**OTEC**<sup>TM</sup>  
AIR CONDITIONING

**Showroom & Technology Center**  
11380 Interchange Circle North  
Miramar, FL 33025 .USA  
Tel: 305 901 1270  
Fax: 954 212 8280  
info@otecomega.com  
www.otecomega.com

BCHBN0A-SM1D0822