

# BEWM-D Ultima Series

50Hz High Wall VRF Indoor Unit

Technical Manual

**220~240V/1/50Hz**

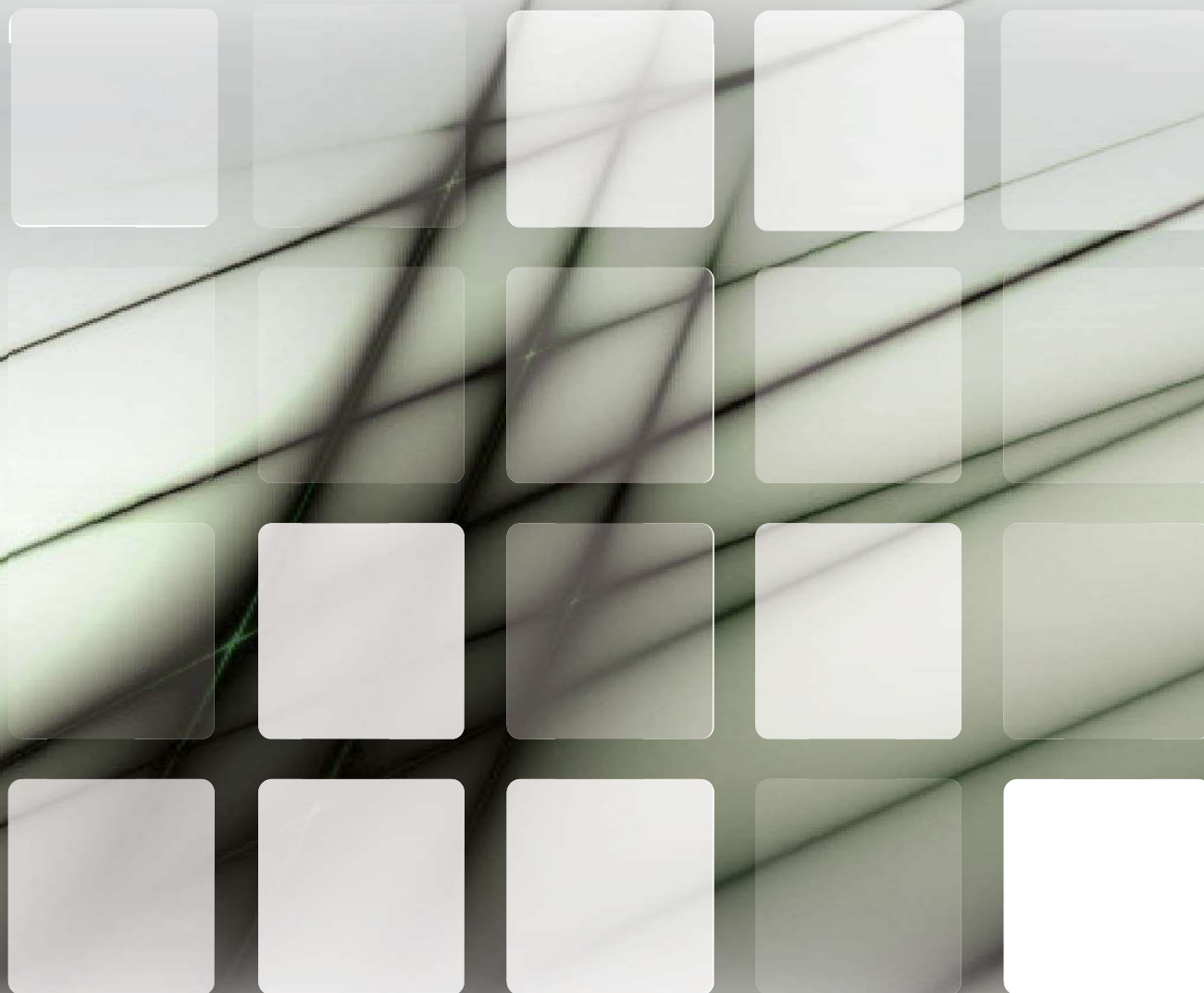

R410A

Commercial Air Conditioners

# Technical Manual

Wall-mounted 50Hz

VRF IDU

Ultima Series



BEWM008Q3A-DWV022

BEWM019Q3A-DWV056

BEWM010Q3A-DWV028

BEWM024Q3A-DWV071

BEWM012Q3A-DWV036

BEWM027Q3A-DWV080

BEWM015Q3A-DWV045

BEWM032Q3A-DWV090

# Wall Mounted

<b>1 Specifications.....</b>	<b>4</b>
<b>2 Dimensions.....</b>	<b>6</b>
<b>3 Indoor Unit Installation.....</b>	<b>7</b>
<b>4 Piping Diagram.....</b>	<b>9</b>
<b>5 Wiring Diagram.....</b>	<b>10</b>
<b>6 Capacity Tables .....</b>	<b>13</b>
<b>7 Electrical Characteristics .....</b>	<b>14</b>
<b>8 Sound Levels.....</b>	<b>15</b>

# Ultima Series VRF Indoor Units

## 1 Specifications

BEWM008Q3A-DWV022; BEWM010Q3A-DWV028; BEWM012Q3A-DWV036; BEWM015Q3A-DWV045

Table 1.1: BEWM008(10,12,15) specifications

Model			BEWM008Q3A-DWV022	BEWM010Q3A-DWV028	BEWM012Q3A-DWV036	BEWM015Q3A-DWV045
Power supply			1 phase, 220-240V, 50Hz			
Cooling <sup>1</sup>	Capacity	kBtu/h	7	9	12	15
	Power input	W	29	29	31	45
Heating <sup>2</sup>	Capacity	kBtu/h	8	10	13	17
	Power input	W	29	29	31	45
Fan Motor Type			AC			
Air flow rate <sup>3</sup>		m <sup>3</sup> /h	446/429/424/409/ 394/382/373	457/445/433/421/4 19/410/402	447/429/399/369 /339/333/303	648/618/582/563/ 546/505/476
Indoor Unit Coil	Number of rows		1	1	1	2
	Tube pitch × row pitch	mm	21x13.37			
	Fin spacing	mm	1.3			
	Fin type		Hydrophilic aluminum			
	Tube OD and type	mm	Φ7 Inner-groove			
	Dimensions (L×H ×W)	mm	585×315×13.37	585×315×13.37	585×315×126.74	701×315×26.74
	Number of circuits		2	3	5	5
External Static Pressure		Pa	0	0	0	0
Sound pressure level <sup>4</sup>		dB(A)	34/33/33/32/32/3 1/31	33/33/32/32/31/31 /31	36/35/34/33/32/3 2/32	37/36/34/34/33/32 /31
Unit	Net dimensions <sup>5</sup> (W×H×D)	mm	835×280×203			990×315×223
	Packed dimensions (W×H×D)	mm	915×353×300			1075×395×300
	Net/Gross weight	kg	8.5/11.0	8.5/11.0	9.7/12.2	13.8/16.4
Refrigerant type			R410A			
Design pressure (H/L)		MPa	4.4/2.6			
Pipe connections	Liquid/Gas pipe	mm	Φ6.35/Φ12.7			
	Drain pipe	mm	OD Φ16			

Notes:

- Indoor temperature 27°C DB, 19°C WB; outdoor temperature 35°C DB; equivalent refrigerant piping length 7.5m with zero level difference.
- Indoor temperature 20°C DB; outdoor temperature 7°C DB, 6°C WB; equivalent refrigerant piping length 7.5m with zero level difference.
- Fan motor speed and air flow rate are from the highest speed to the lowest speed, total 7 rates for each model.
- Sound pressure level is from highest level to lowest level, total 7 levels for each model. Sound pressure level is measured in a semi-anechoic chamber.
- Unit body dimensions given are the largest external dimensions of the unit, including hanger attachments.

## Ultima Series VRF Indoor Units

**BEWM019Q3A-DWV056; BEWM024Q3A-DWV071 ; BEWM027Q3A-DWV080 ; BEWM032Q3A-DWV090**

Table 1.2: BEWM019(24,28,32) specifications

Model			BEWM019Q3A-DWV056	BEWM024Q3A-DWV071	BEWM027Q3A-DWV080	BEWM032Q3A-DWV090
Power supply			1 phase, 220-240V, 50Hz			
Cooling <sup>1</sup>	Capacity	kBtu/h	19	24	27	30
	Power input	W	54	77	77	90
Heating <sup>2</sup>	Capacity	kBtu/h	21	27	30	34
	Power input	W	54	77	77	90
Fan Motor type			AC			
Air flow rate <sup>3</sup>		m <sup>3</sup> /h	798/764/723/691/ 665/627/595	1240/1171/1107/1 045/976/914/869	1248/1194/1119/1 056/993/914/863	1427/1403/1303/12 32/1186/1096/1043
Indoor Unit Coil	Number of rows		2	2	2	2
	Tube pitch × row pitch	mm	21x13.37			
	Fin spacing	mm	1.3			
	Fin type		Hydrophilic aluminum			
	Tube OD and type	mm	Φ7 Inner-groove			
	Dimensions (L×H ×W)	mm	701×315×26.74	825×399×26.74	825×399×26.74	825×399×26.74
	Number of circuits		5	5	6	5
External Static Pressure		Pa	0	0	0	0
Sound pressure level <sup>4</sup>		dB(A)	42/41/40/39/38/3 7/36	48/47/45/44/42/39 /38	48/47/45/43/42/3 9/38	52/51/50/49/47/45/ 43
Unit	Net dimensions <sup>5</sup> (W×H×D)	mm	990×315×223	1194×343×262		
	Packed dimensions (W×H×D)	mm	1075×395×300	1265×420×345		
	Net/Gross weight	kg	13.8/16.4	17.4/20.8	17.6/21.0	17.6/21.0
Refrigerant type			R410A			
Pipe connections	Liquid/Gas pipe	mm	Φ9.53/Φ15.9			
	Drain pipe	mm	OD Φ16			

**Notes:**

1. Indoor temperature 27°C DB, 19°C WB; outdoor temperature 35°C DB; equivalent refrigerant piping length 7.5m with zero level difference.
2. Indoor temperature 20°C DB; outdoor temperature 7°C DB, 6°C WB; equivalent refrigerant piping length 7.5m with zero level difference.
3. Fan motor speed and air flow rate are from the highest speed to the lowest speed, total 7 rates for each model.
4. Sound pressure level is from highest level to lowest level, total 7 levels for each model. Sound pressure level is measured in a semi-anechoic chamber.
5. Unit body dimensions given are the largest external dimensions of the unit, including hanger attachments.

# Ultima Series VRF Indoor

## Units 2 Dimensions

### 2.1 Unit Dimensions

Figure 2.1: Wall mounted dimensions (unit: mm)

BEWM008Q3A-DWV022 ; BEWM010Q3A-DWV028, BEWM012Q3A-DWV036,



BEWM015Q3A-DWV045, BEWM019Q3A-DWV056

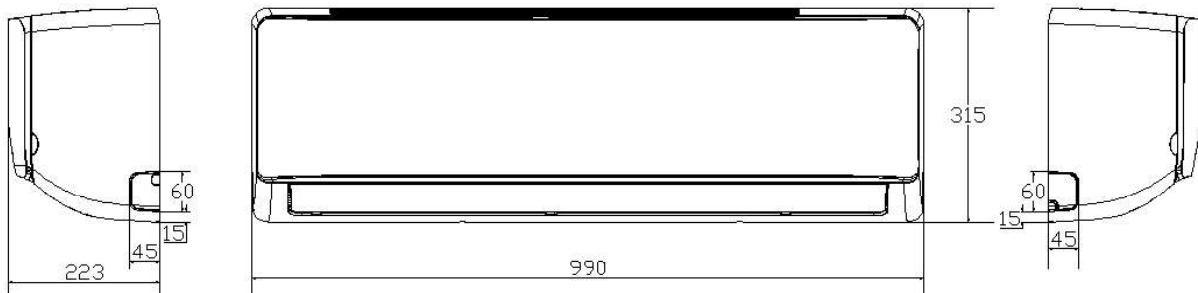

BEWM024Q3A-DWV071, BEWM027Q3A-DWV080, BEWM032Q3A-DWV090

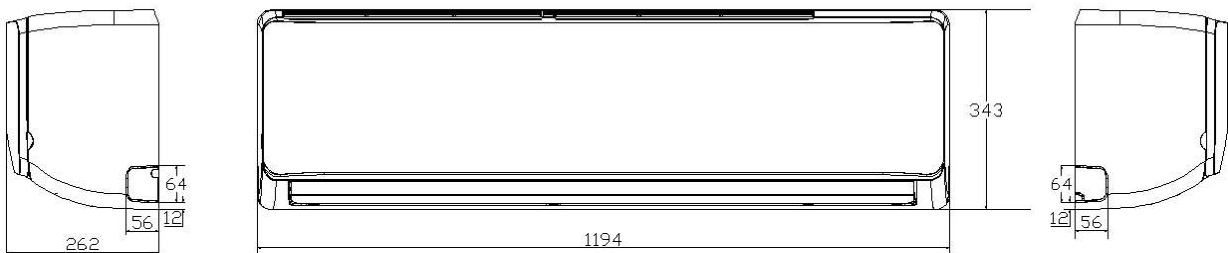

## 3 Indoor Unit Installation

### 3.1 Choosing an Installation Site

Unit placement should take account of the following considerations:

- Units should not be installed in the following locations:
  - Where exposure to direct radiation from a high-temperature heat source or to interference from a source of electromagnetic radiation may occur.
  - Where dust or dirt may affect heat exchangers.
  - Where exposure to oil or to corrosive or harmful gases, such as acidic or alkaline gases, may occur.
  - Where exposure to salinity may occur, such as seaside locations.
  - Where highly flammable materials are present.
  - Where exposure to oily air may occur, such as a kitchen.
  - Where exposure to very high humidity may occur, such as a laundry.
- Units should be installed in positions where:
  - The ceiling is horizontal and is able to bear the unit's weight.
  - There are no obstructions that could impede the airflow into and out of the unit.
  - The airflow out of the unit can reach throughout the room.
  - There is sufficient space for access during installation, servicing and maintenance.
  - The refrigerant piping and drain piping can be easily connected to the refrigerant piping and drain piping systems.
  - Short-circuit ventilation (where outlet air returns quickly to a unit's air inlet) will not occur.

### 3.2 Drill and Mount the rack for the indoor unit

Rack Dimensions and directions (unit: mm)

Figure 3.1: Wall mounted space requirements (unit: mm)

**BEWM008Q3A-DWV022, BEWM010Q3A-DWV028**

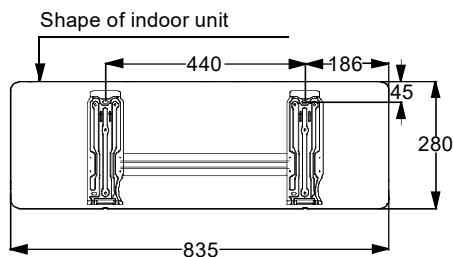

**BEWM012Q3A-DWV036, BEWM015Q3A-DWV045, BEWM019Q3A-DWV056**

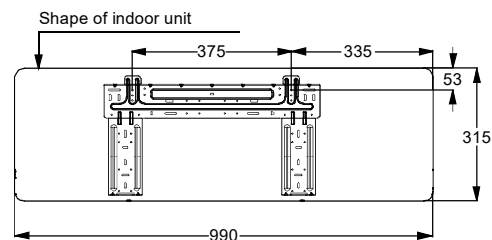

**BEWM024Q3A-DWV071, BEWM027Q3A-DWV080, BEWM032Q3A-DWV090**

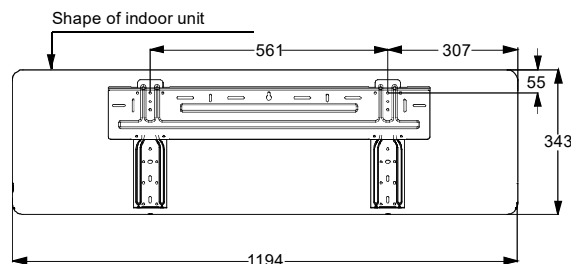

## Atom Series VRF Indoor Units

### 3.2.1 Mounting the Rack of the indoor unit

Select the installation location, and remove the installation panel from the back of the indoor unit, and place it on the installation position you have selected earlier. At this time, make sure the unit is level, and maintain the dimensions of the bottom, top, left and right sides of the unit. Determine the positions of the wall holes to secure the panel.

#### Correct Installation Method

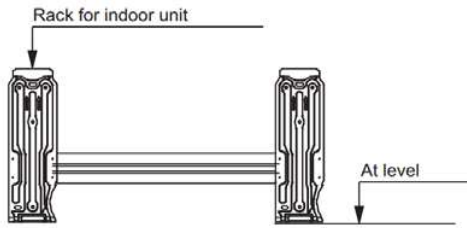

#### Wrong Installation

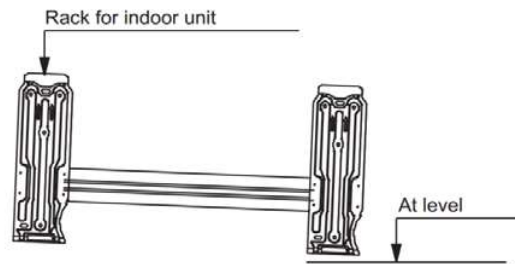
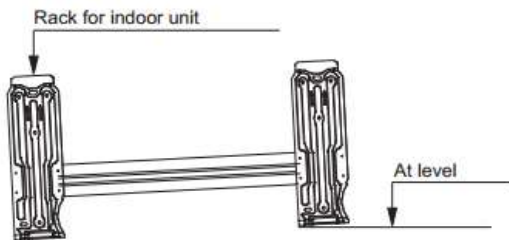

### 3.2.2 Installation on Wood-based structure

- 1) Before installation, make sure that the wooded walls are strong enough.
- 2) Determine the upper and lower positions of the installation panel based on the distance between the indoor unit and the ceiling.
- 3) With reference to the screw holes of the installation panel as the center, adjust the distance on the left and right sides.
- 4) Fix the installation panel on the wall using self-tapping screws.

### 3.2.3 Installation on Concrete Structure

- 1) With reference to the installation panel, drill holes in the wall to embed the plastic expansion pipes.
- 2) Fix the installation panel on the wall using self-tapping screws.

### 3.2.4 Indoor Unit Installation

- 1) Pass the properly bundled pipeline and connection lines through the wall hole, making sure that the pipe socket is not damaged, and the connecting pipes of the unit are sand-free and dust-free.
- 2) Hang the upper jaw at the back of the indoor unit on the upper hooker of the installation panel. Shift the indoor unit left and right to check that the hanging is secure and firm.
- 3) Push the lower part of the indoor unit against the wall, and shift the unit body up and down and left and right to check that the connection is secure.
- 4) Place a block of shock absorbing material in between the indoor unit and wall to support the indoor unit. Remove the shock absorbing material when the piping installation work is completed. Until the indoor unit can be connected properly, make sure that the indoor unit is buckled into the slots. Use your hands to shake the unit to check that it does not move up, down, left or right. Use a spirit level to verify that the indoor unit is level.

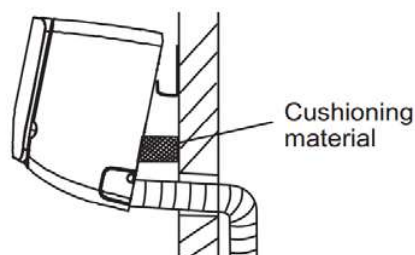
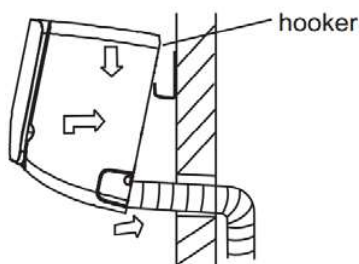



## 4 Piping Diagram

Figure 4.1: Wall mounted piping diagram

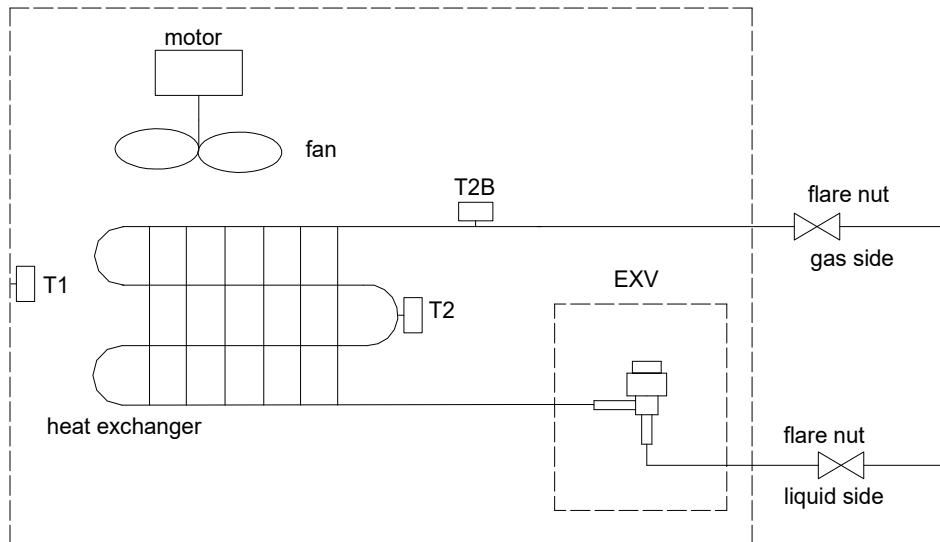

Legend	
T1	Indoor ambient temperature sensor
T2	Indoor heat exchanger mid-point temperature sensor
T2B	Indoor heat exchanger outlet temperature sensor

# Ultima Series VRF Indoor Units

## 5 Wiring Diagram

Figure 5.1: 7.0/9.0/12.0kBTu/h Wall mounted wiring diagram

Code	Name	Code	Name	Code	Name
FM	Indoor fan motor	T1	Indoor ambient temp. sensor	CS	Water level switch
GM	Swing motor	T2	Indoor heat exchanger mid-point temp. sensor	XP1-5/XS1-5	Connectors
EEV	Electronic expansion valve	T2B	Indoor heat exchanger outlet temp. sensor		

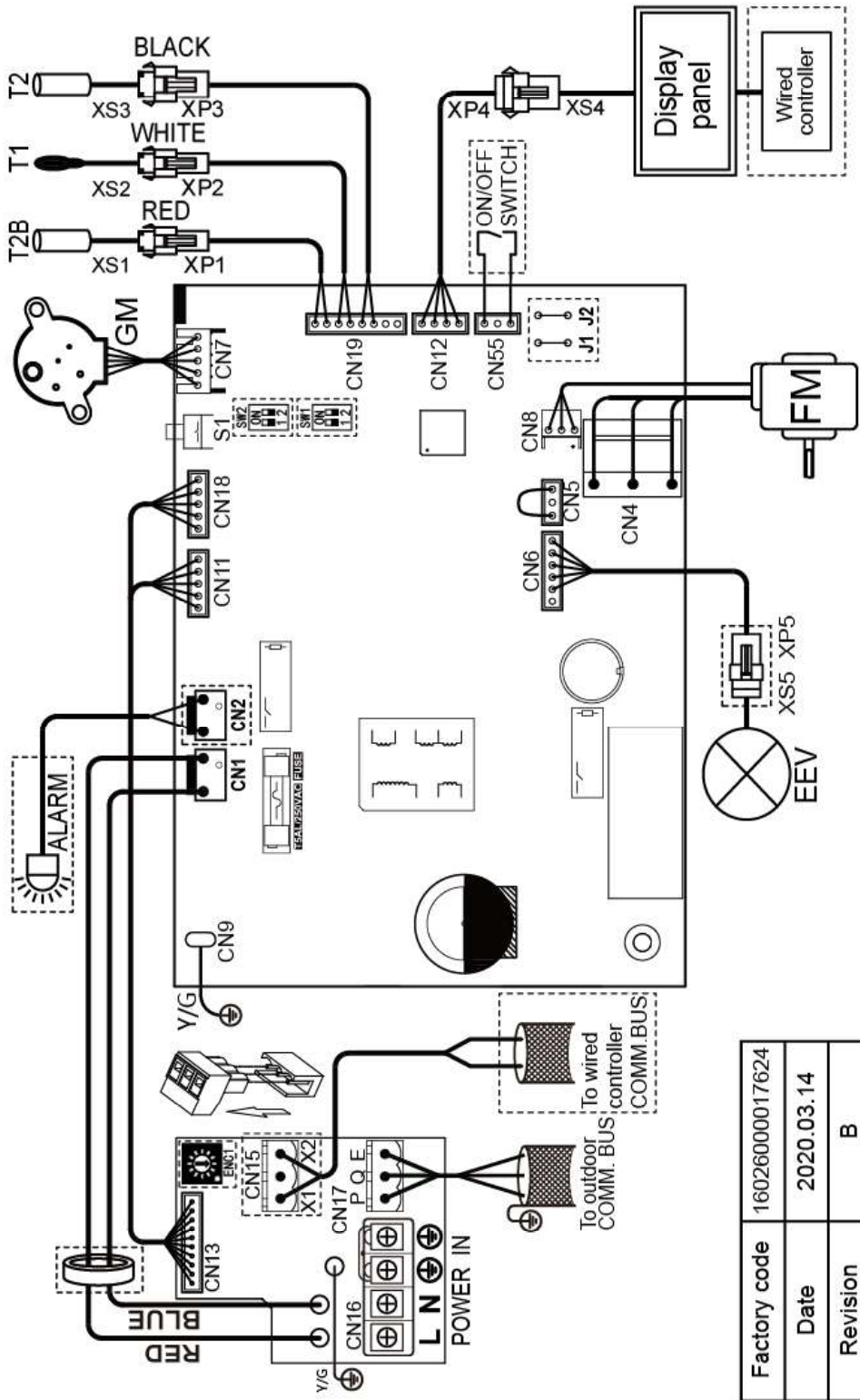

Factory code	16026000017624
Date	2020.03.14
Revision	B

Figure 5.2: 15.0/18.0kBTu/h Wall mounted wiring diagram

Code	Name	Code	Name	Code	Name
FM	Indoor fan motor	T1	Indoor ambient temp. sensor	CS	Water level switch
GM	Swing motor	T2	Indoor heat exchanger mid-point temp. sensor	XP1-5/XS1-5	Connectors
EEV	Electronic expansion valve	T2B	Indoor heat exchanger outlet temp. sensor	C	Capacitor

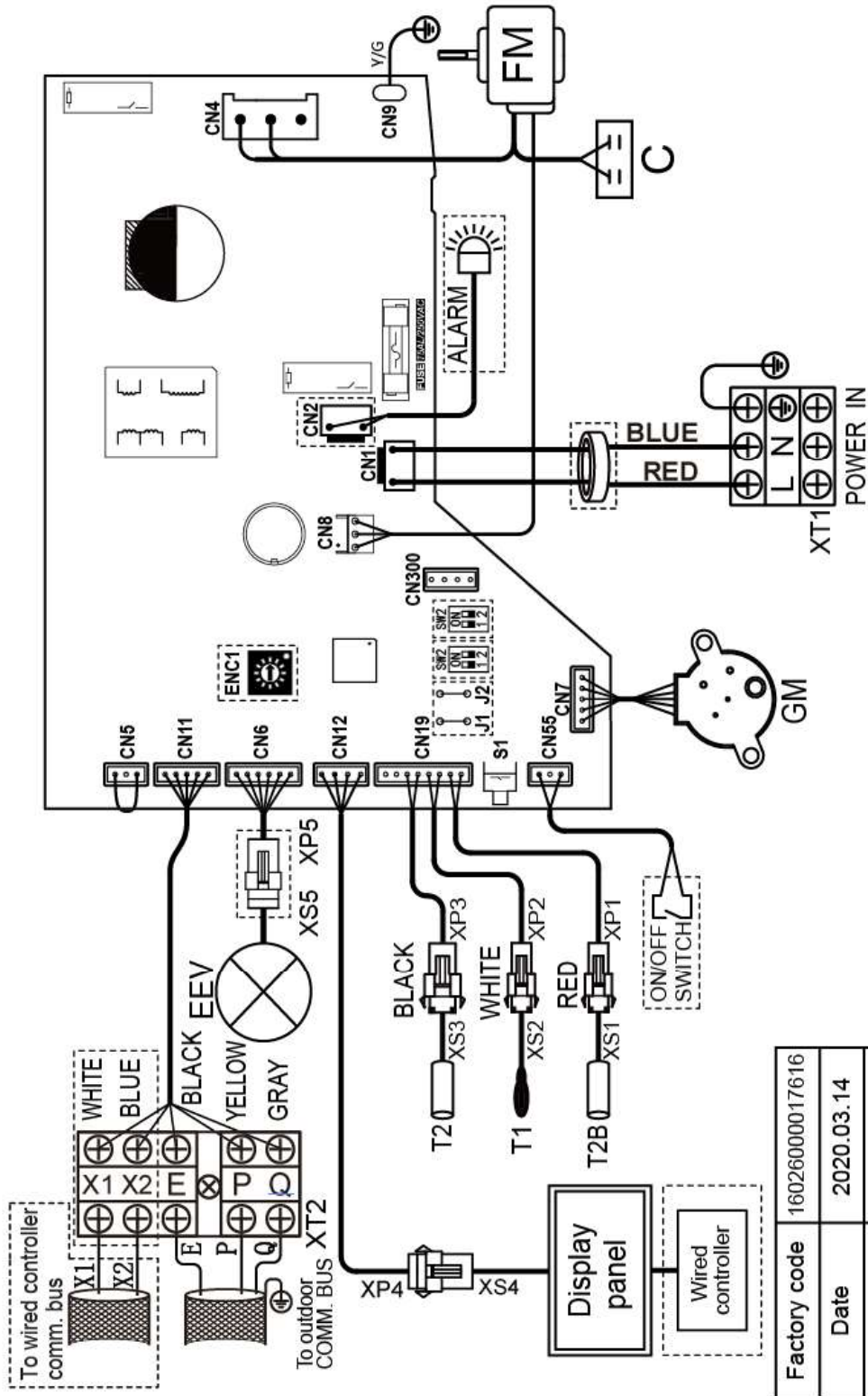

Factory code	16026000017616
Date	2020.03.14
Revision	B

# Ultima Series VRF Indoor Units

Figure 5.3: 24.0/28.0/32.0kBtu/h Wall mounted wiring diagram

Code	Name	Code	Name	Code	Name
FM	Indoor fan motor	T1	Indoor ambient temp. sensor	CS	Water level switch
GM	Swing motor	T2	Indoor heat exchanger mid-point temp. sensor	XP1-5/XS1-5	Connectors
EEV	Electronic expansion valve	T2B	Indoor heat exchanger outlet temp. sensor	C	Capacitor

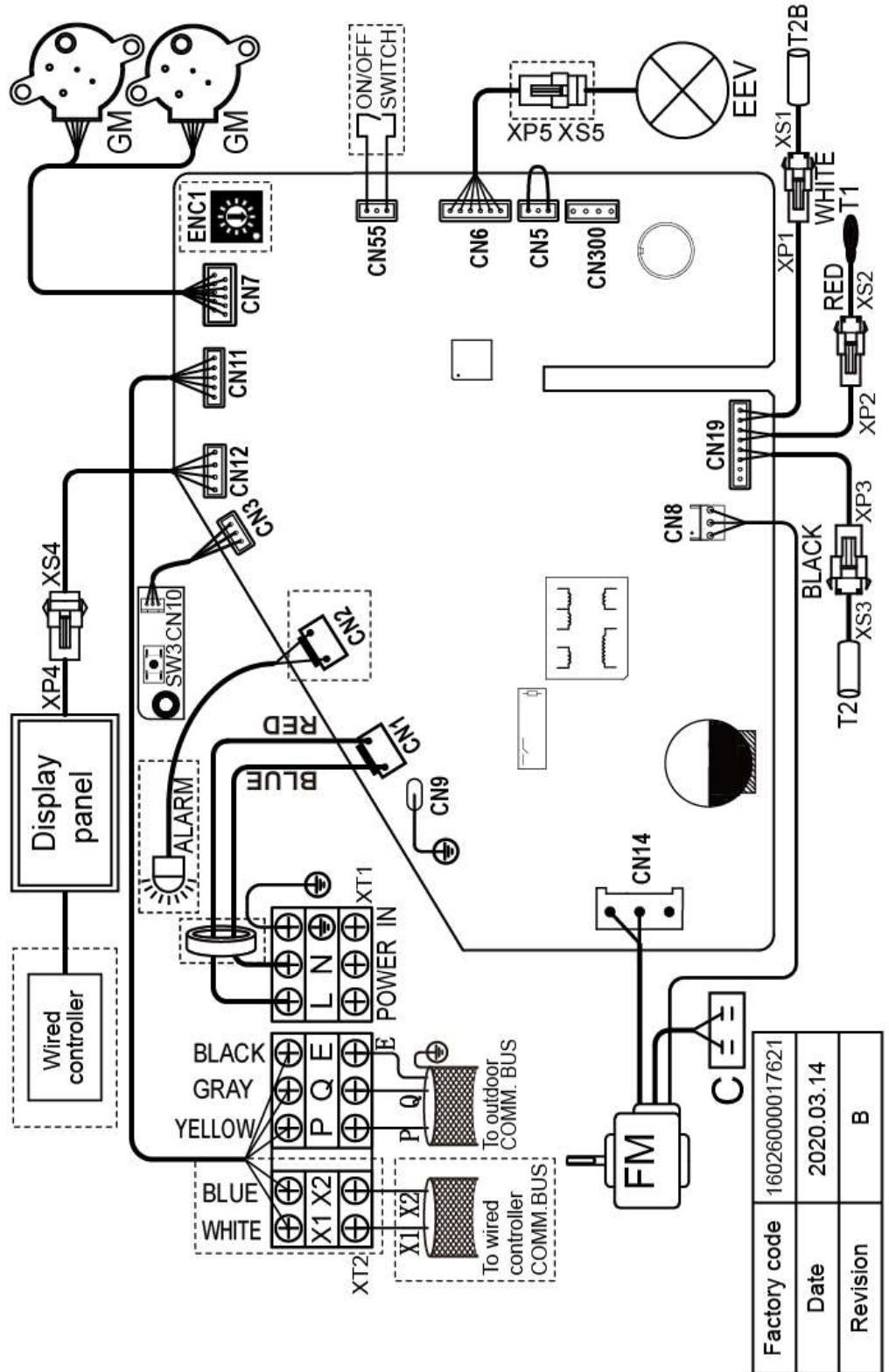

Factory code	16026000017621
Date	2020.03.14
Revision	B

## 6 Capacity Tables

### 6.1 Cooling Capacity Table

Table 6.1: Wall mounted cooling capacity

Model	Indoor air temperature (°C WB/DB)													
	14/20		16/23		18/26		19/27		20/28		22/30		24/32	
	TC	SC	TC	SC	TC	SC	TC	SC	TC	SC	TC	SC	TC	SC
BEWM008Q3A-DWV022	2.0	2.0	2.1	2.0	2.2	2.0			2.3	1.9	2.3	1.7	2.4	1.7
BEWM010Q3A-DWV028	2.5	2.5	2.7	2.6	2.8	2.5			2.9	2.4	2.9	2.2	3.0	2.1
BEWM012Q3A-DWV036	3.2	3.2	3.4	3.2	3.6	3.2			3.7	3.0	3.8	2.8	3.9	2.7
BEWM015Q3A-DWV045	4.0	3.9	4.3	3.9	4.5	3.9			4.6	3.6	4.7	3.4	4.8	3.3
BEWM019Q3A-DWV056	5.0	4.8	5.3	4.8	5.6	4.8			5.7	4.5	5.8	4.2	6.0	4.1
BEWM024Q3A-DWV071	6.3	6.2	6.7	6.1	7.0	6.1			7.2	5.7	7.4	5.4	7.6	5.2
BEWM027Q3A-DWV080	7.1	6.9	7.6	7.0	7.9	6.8			8.1	6.4	8.3	6.1	8.5	5.8
BEWM032Q3A-DWV090	8.0	7.9	8.5	7.9	8.9	7.8			9.1	7.2	9.4	6.9	9.6	6.6

Abbreviations:

TC: Total capacity (kW)

SC: Sensible capacity(kW)

Notes:

1. Shaded cells indicate rating condition.

### 6.2 Heating Capacity Table

Table 6.2: Wall mounted heating capacity

Model	Indoor air temperature (°C DB)					
	16	18	20	21	22	24
	TC	TC	TC	TC	TC	TC
BEWM008Q3A-DWV022	2.6	2.6	2.4	2.3	2.3	2.1
BEWM010Q3A-DWV028	3.4	3.4	3.2	3.1	3.0	2.8
BEWM012Q3A-DWV036	4.2	4.2	4.0	3.8	3.8	3.5
BEWM015Q3A-DWV045	5.3	5.3	5.0	4.8	4.7	4.4
BEWM019Q3A-DWV056	6.7	6.6	6.3	6.1	5.9	5.5
BEWM024Q3A-DWV071	8.5	8.4	8.0	7.8	7.5	7.0
BEWM027Q3A-DWV080	9.5	9.5	9.0	8.7	8.5	7.8
BEWM032Q3A-DWV090	10.6	10.5	10.0	9.7	9.4	8.8

Abbreviations:

TC: Total capacity (kW)

Notes:

1. Shaded cells indicate rating condition.

# Ultima Series VRF Indoor

## Units 7 Electrical Characteristics

Table 7.1: Wall mounted electrical characteristics

Model	Power supply						Indoor fan motors	
	Hz	Volts	Min. volts	Max. volts	MCA	MFA	Rated motor output (kW)	FLA
BEWM008Q3A-DWV022	50	220-240	198	264	0.32	15	0.02	0.2
BEWM010Q3A-DWV028	50	220-240	198	264	0.32	15	0.02	0.2
BEWM012Q3A-DWV036	50	220-240	198	264	0.45	15	0.02	0.23
BEWM015Q3A-DWV045	50	220-240	198	264	0.47	15	0.045	0.35
BEWM019Q3A-DWV056	50	220-240	198	264	0.58	15	0.045	0.4
BEWM024Q3A-DWV071	50	220-240	198	264	0.90	15	0.05	0.45
BEWM027Q3A-DWV080	50	220-240	198	264	0.90	15	0.05	0.45
BEWM032Q3A-DWV090	50	220-240	198	264	1.10	15	0.05	0.52

Abbreviations:

MCA: Minimum Circuit Amperes

MFA: Minimum Fuse Amperes

IFM: Indoor Fan Motor

kW: Rated motor output

FLA: Full Load Amperes

## 8 Sound Levels

### 8.1 Overall

Table 8.1: Wall mounted sound pressure levels<sup>1</sup>

Model name	Sound pressure levels dB(A)						
	SSH	SH	H	M	L	SL	SSL
BEWM008Q3A-DWV022	34	33	33	32	32	31	31
BEWM010Q3A-DWV028	34	33	32	32	31	31	31
BEWM012Q3A-DWV036	36	35	34	33	32	32	32
BEWM015Q3A-DWV045	37	36	34	34	33	32	31
BEWM019Q3A-DWV056	42	41	40	39	38	37	36
BEWM024Q3A-DWV071	48	47	45	44	42	39	38
BEWM027Q3A-DWV080	48	47	45	43	42	39	38
BEWM032Q3A-DWV090	52	51	50	49	47	45	43

Notes:

1. Sound pressure levels are measured in a semi-anechoic chamber. During in-situ operation, sound pressure levels may be higher as a result of ambient noise.

Figure 8.1: Wall mounted sound pressure level measurement

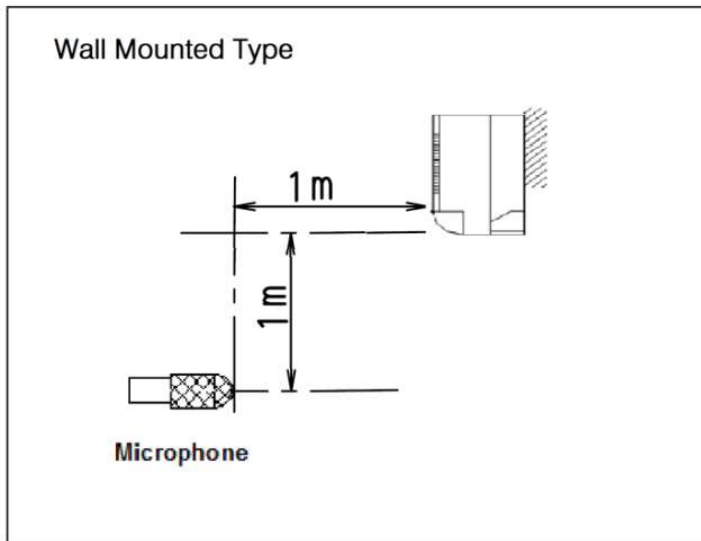

# Ultima Series VRF Indoor

## Units 8.2 Octave Band Levels

BEWM008Q3A-DWV022

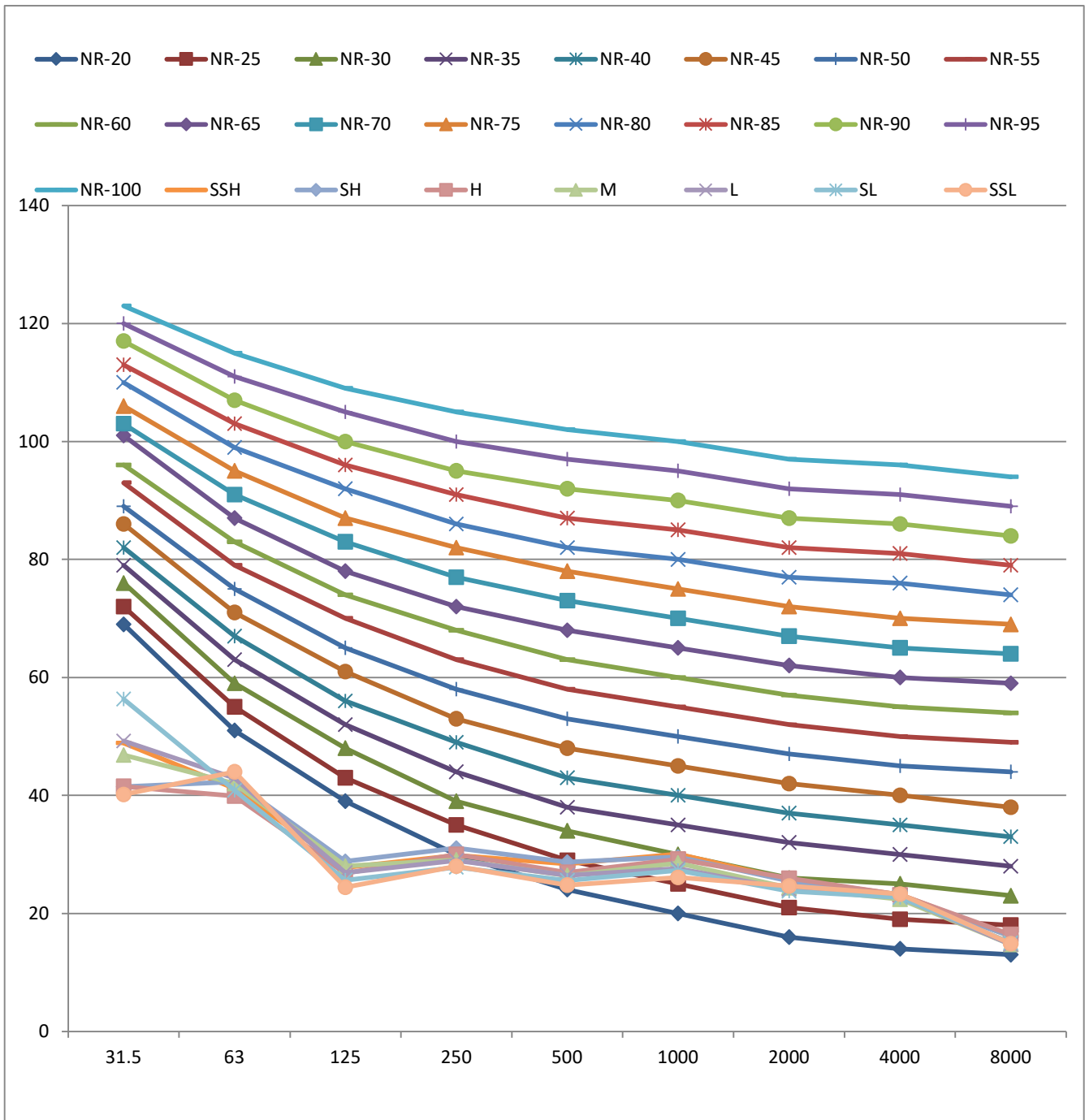



BEWM010Q3A-DWV028

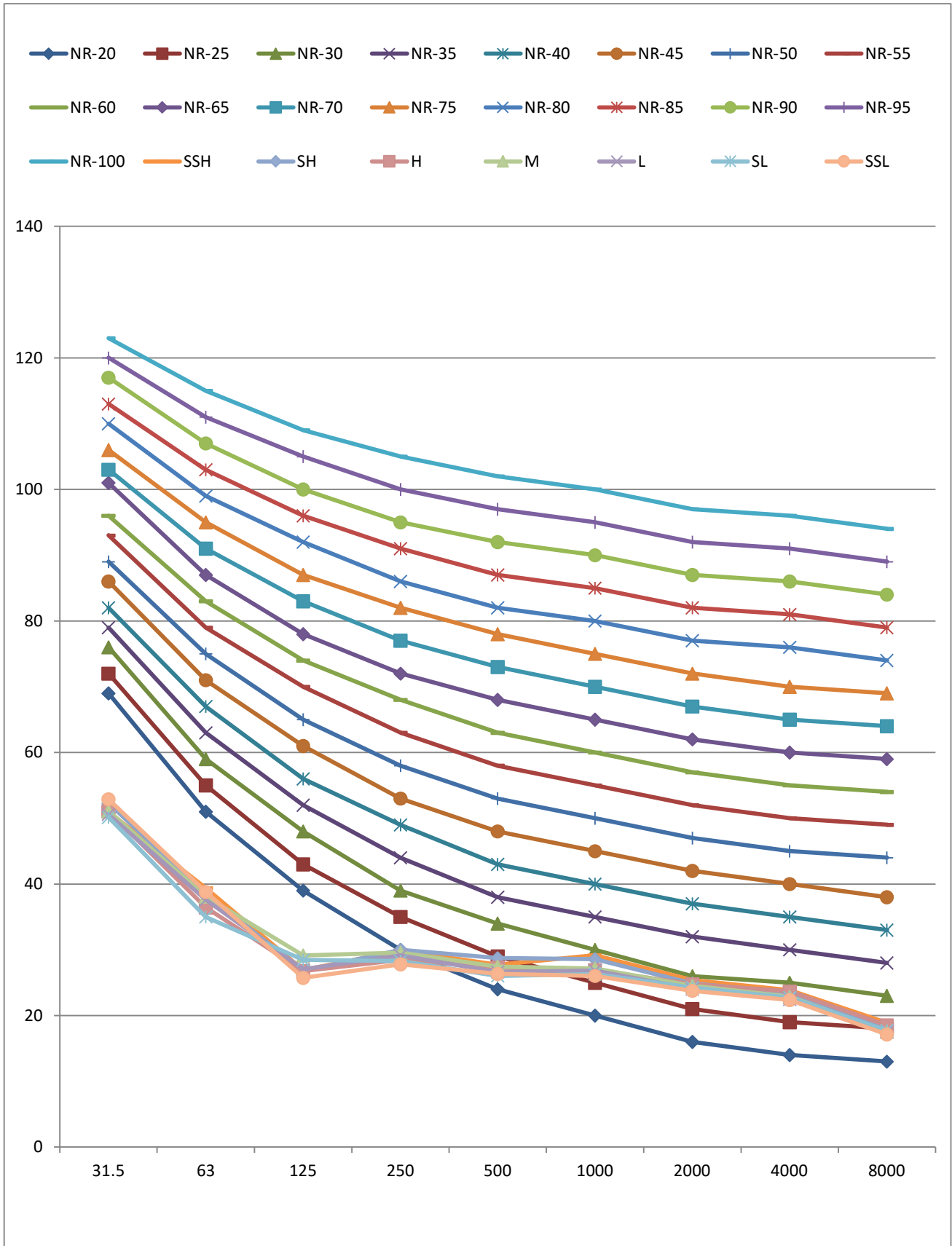

# Ultima Series VRF Indoor Units

BEWM012Q3A-DWV036

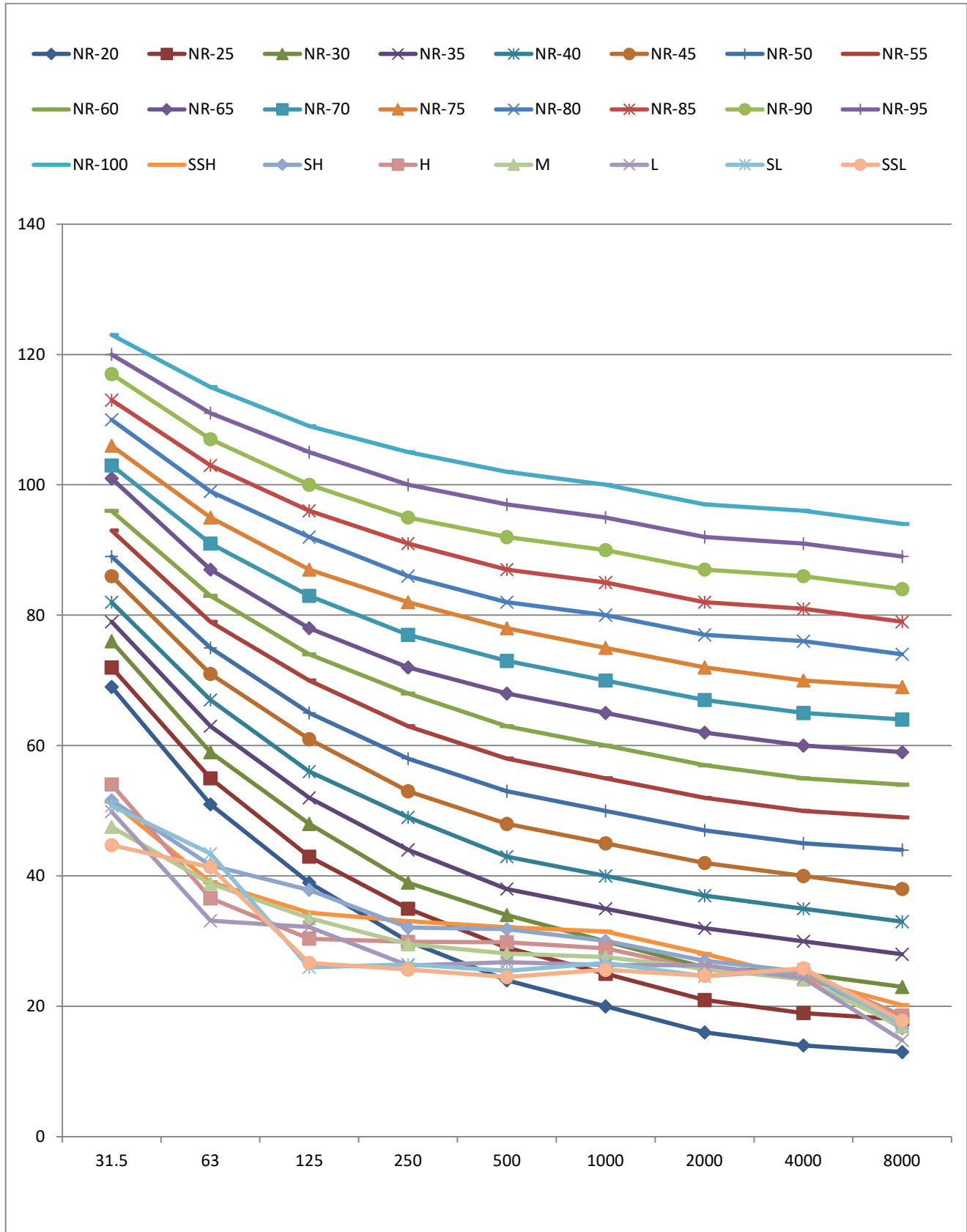

# Ultima Series VRF Indoor Units

BEWM015Q3A-DWV045

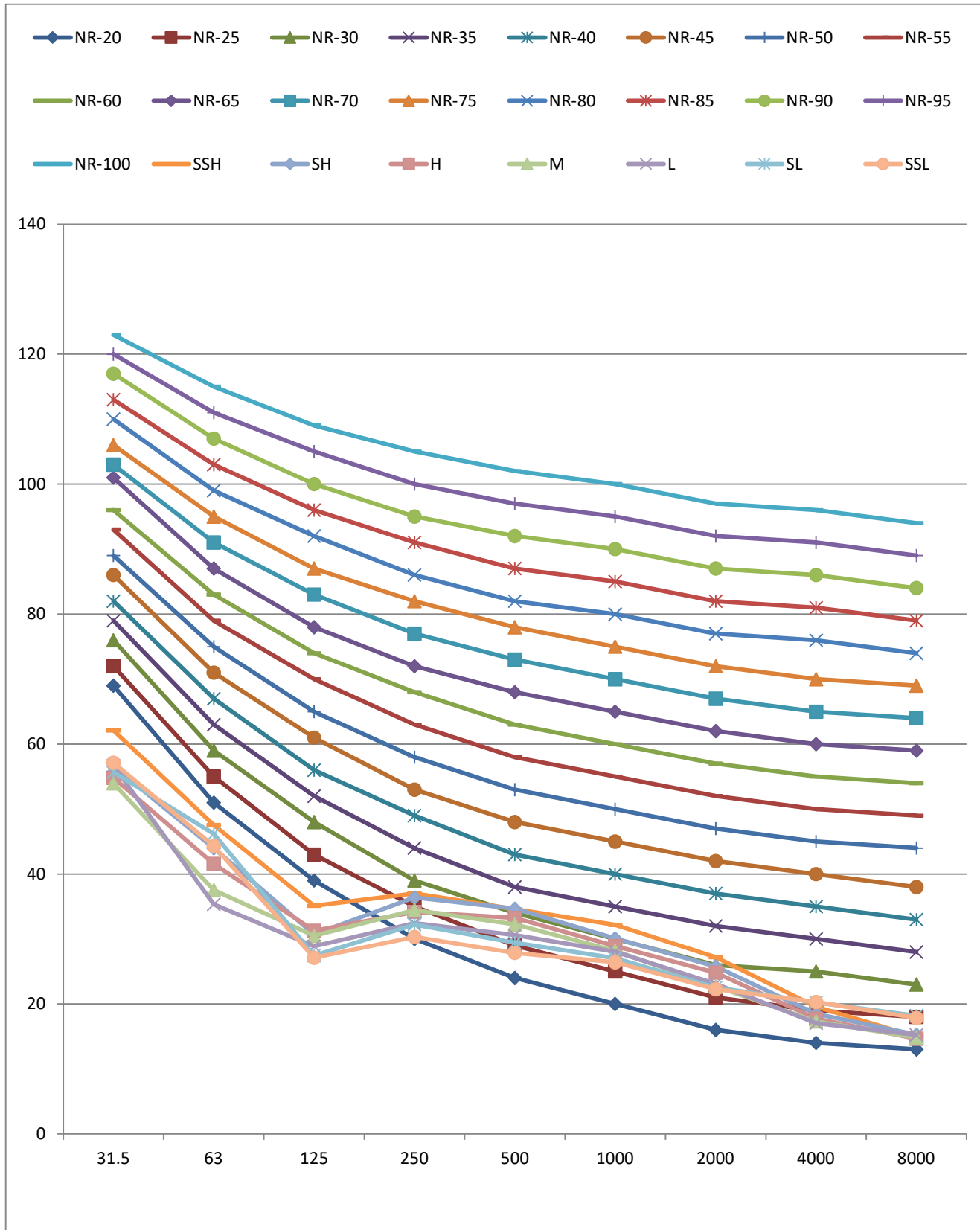

# Ultima Series VRF Indoor Units

BEWM019Q3A-DWV056

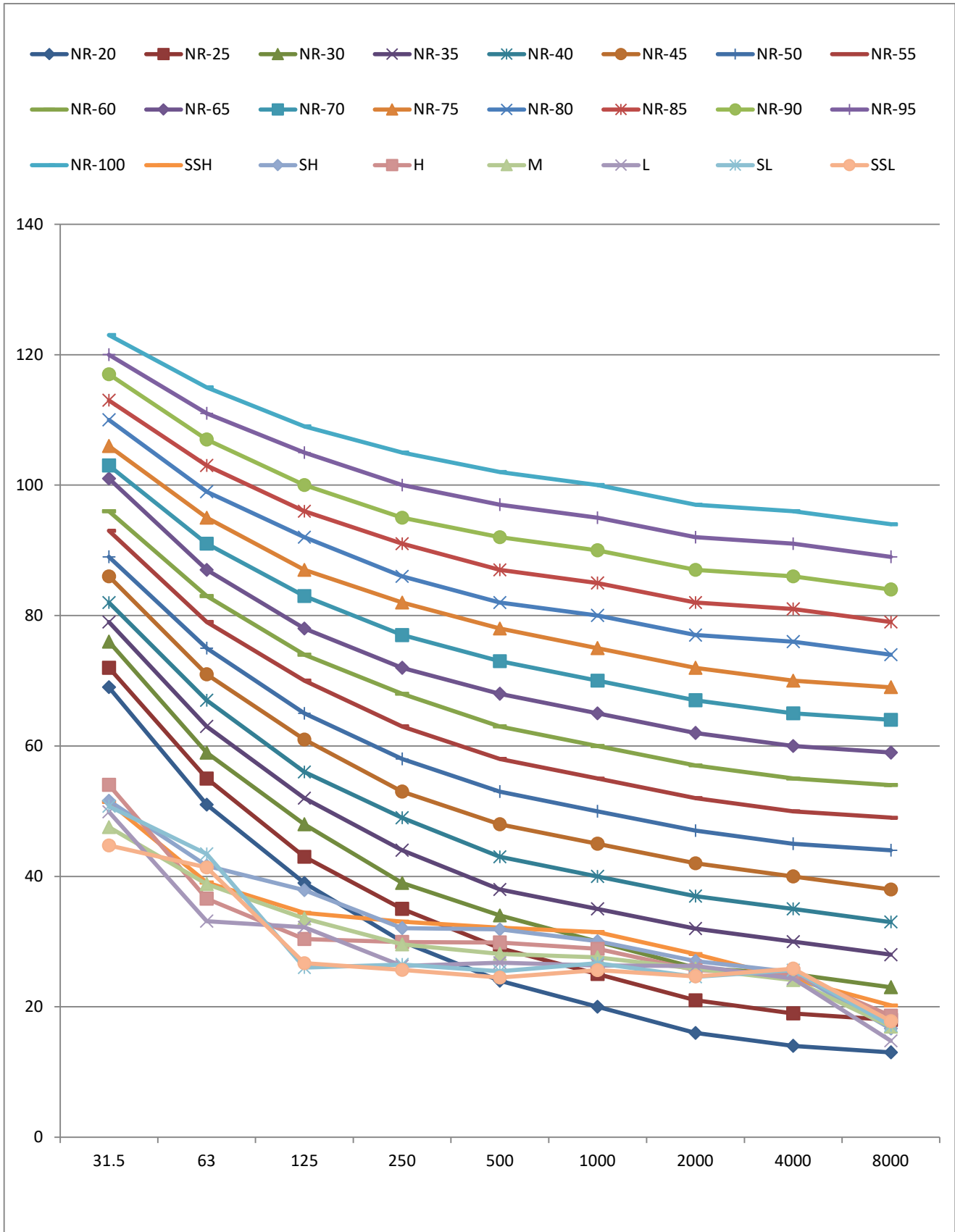

# Ultima Series VRF Indoor Units

BEWM024Q3A-DWV071

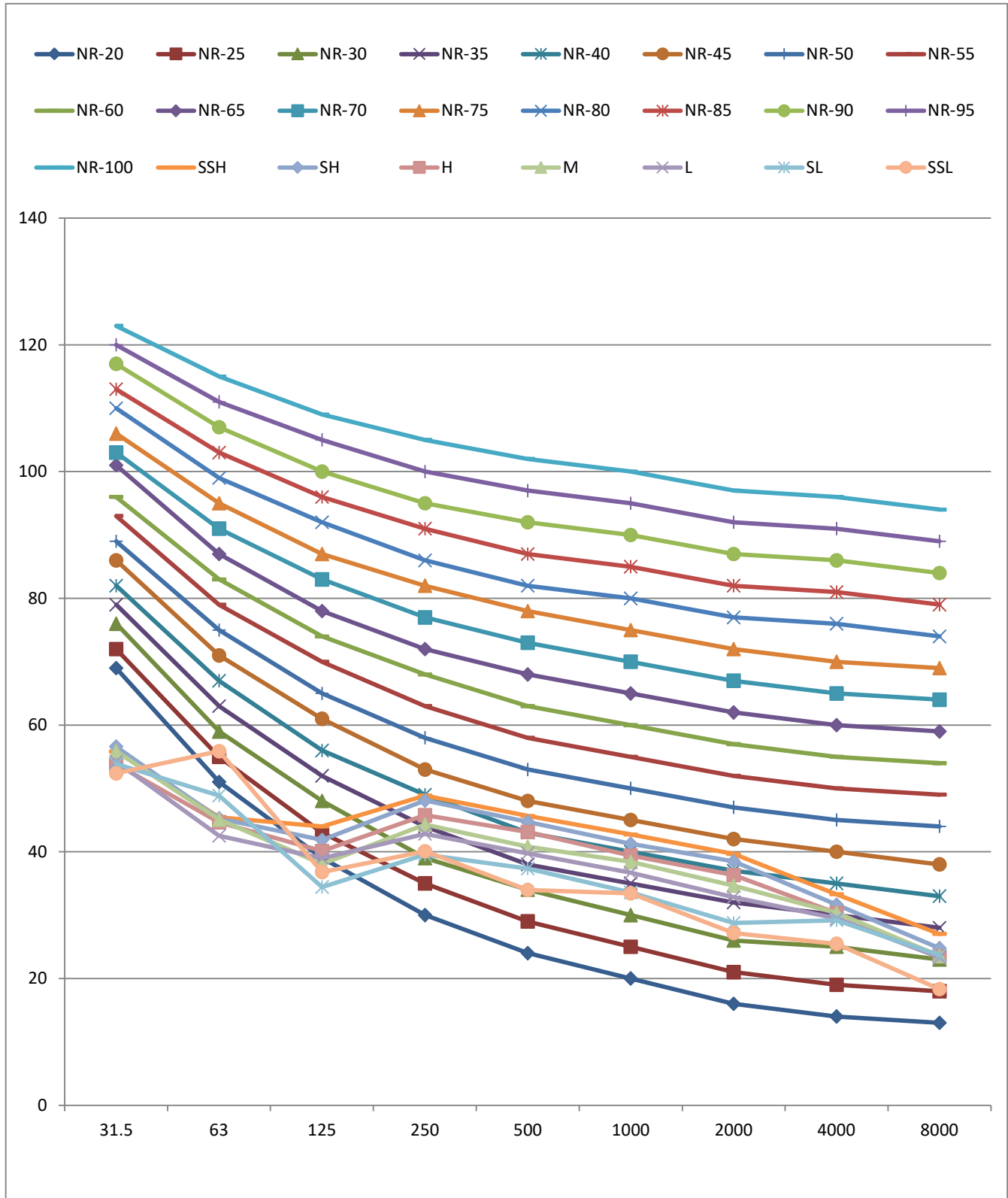

# Ultima Series VRF Indoor Units

BEWM027Q3A-DWV080

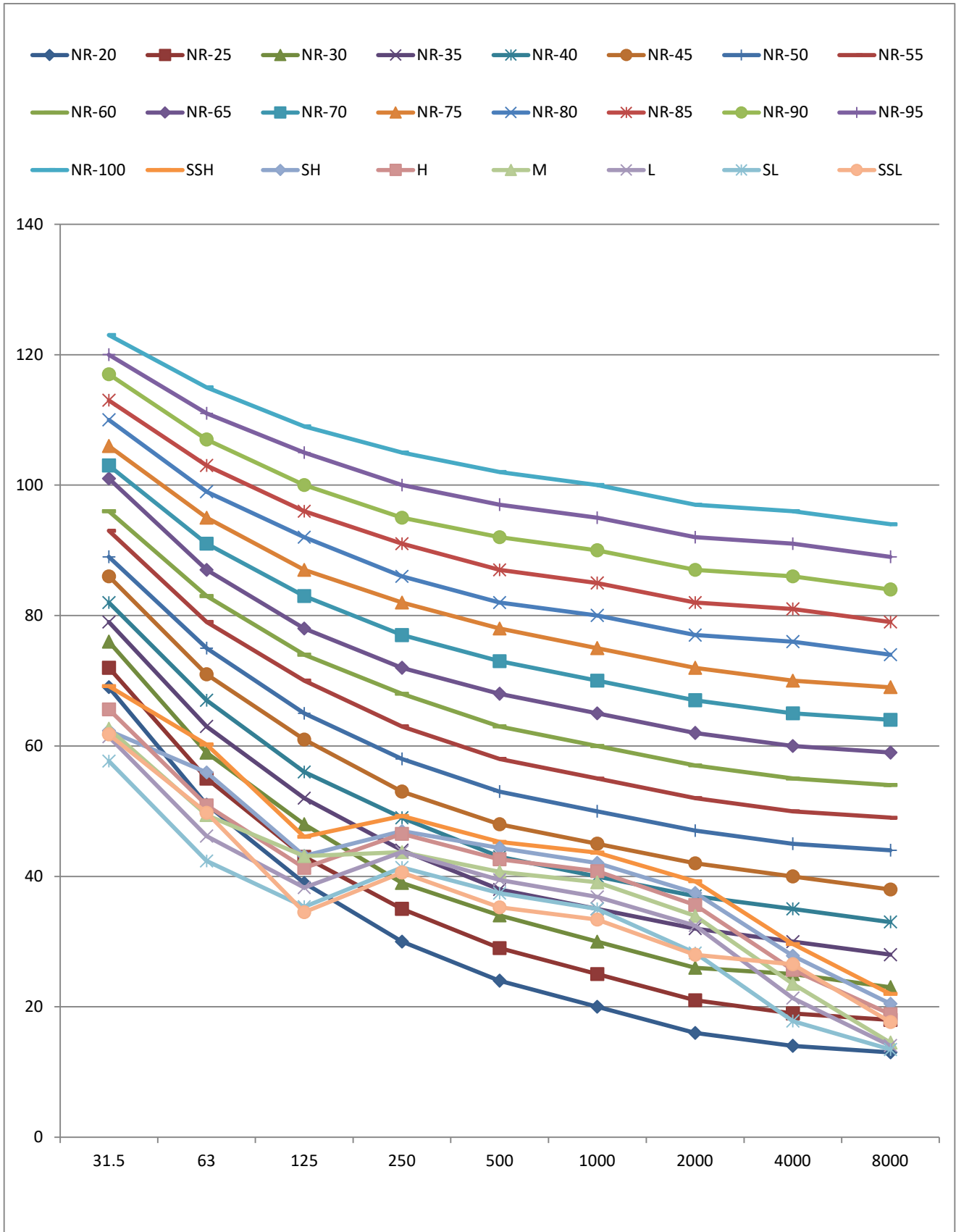

# Ultima Series VRF Indoor Units

BEWM032Q3A-DWV090

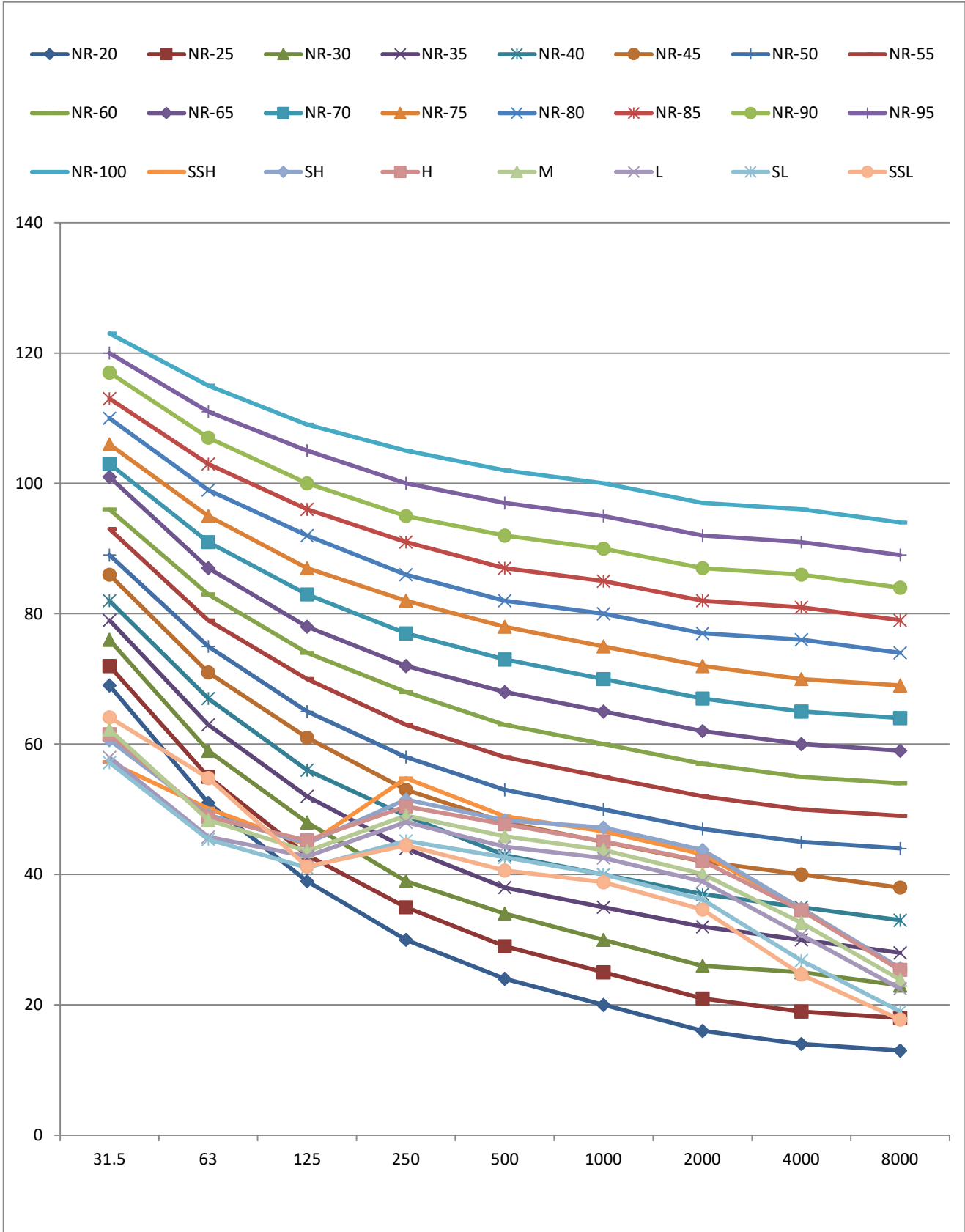



**OMEGA**  
ENVIRONMENTAL  
TECHNOLOGIES LLC.

17702 Mitchell North, #101  
Irvine, CA. 92614 .USA  
Tel: 714 795 2830  
Fax: 714 966 1646  
info@omegainverter.com  
www.omegainverter.com

**OTEC**<sup>TM</sup>  
AIR CONDITIONING

**Showroom & Technology Center**  
11380 Interchange Circle North  
Miramar, FL 33025 .USA  
Tel: 305 901 1270  
Fax: 954 212 8280  
info@otecomega.com  
wwwotecomega.com

BEWMQ3A-TM1D0721