

# TELP(MP) Series

Ducted R32 Indoor Unit  
Service Manual

**220~240V/1/50Hz**

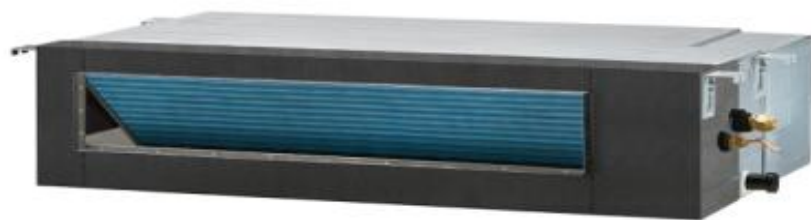

# CONTENTS

<b>Part I Technical Information</b> .....	4
<b>1. Important Notice</b> .....	4
<b>2. Model List</b> .....	5
2.1 Indoor Units.....	5
2.2 Outdoor Units.....	5
<b>3. PRODUCT DATA</b> .....	7
3.1 Specifications Sheet.....	7
3.2 The curve of Static Pressure(Duct Type).....	11
3.3 Guidelines for static pressure regulation.....	14
3.4 Sound Levels.....	14
3.5 Operation Limits.....	15
3.6 Product Dimensions.....	16
3.7 Wiring Diagram.....	18
3.8 PCB Layout.....	23
3.9 Built-in Draining Pump.....	26
<b>4. Electronic Controller Introduction</b> .....	27
4.1 Remote Controller.....	27
4.2 Wired Remote Controller.....	29
<b>PART II Installation and Maintenance</b> .....	32
<b>1. Notes for Installation and Maintenance</b> .....	32
<b>2. Installation</b> .....	41
2.1 Location Selection.....	41
2.2 Indoor Unit Installation.....	41
2.3 Outdoor Unit Installation.....	45
2.4 Drainage Pipe Installation.....	46
2.5 Vacuum Drying and Leakage Detection.....	46
2.6 Additional Refrigerant Charge.....	49
2.7 Engineering of Insulation.....	49
2.8 Engineering of Electrical Wiring.....	50
2.9 Test Operation.....	54
<b>3. Maintenance</b> .....	55
3.1 Display Board.....	55
3.2 Failure Code.....	56
1.1 Trouble Shooting.....	59
<b>APPENDIX</b>	
Appendix 1 The Comparison Table of Celsius-Fahrenheit Temperature.....	75
Appendix 2 Temperature Sensor Resistance Value Table (°C--K).....	75
Appendix 3.....	76
Appendix 4.....	77

---

## **Part I Technical Information**



### **1. Important Notice**

This service manual is intended for use by individuals possessing adequate backgrounds of electrical, electronic and mechanical experience. Any attempt to repair the appliance may result in personal injury and property damage. The manufacturer or seller cannot be responsible for the interpretation of this information, nor can it assume any liability in connection with its use.

The information, specifications and parameter are subject to change due to technical modification or improvement without any prior notice. The accurate specifications are presented on the nameplate label.

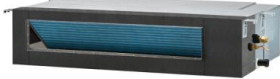

## 2. Model List

### 2.1 Indoor Units

Duct Type	TELP112J0T-LCL036 TELP118J0T-LCL053	12500/13500 18000/19500	220-240V~1ph 50Hz	
	TELP124J0T-LCL070	24000/26000	220-240V~1ph 50Hz	
	TEMP130J0T-LCL085	30000/32000	220-240V~1ph 50Hz	
	TEMP136J0T-LCL105	36000/39000	220-240V~1ph 50Hz	
	TEMP148J0T-LCL140	46000/55000	220-240V~1ph 50Hz	
	TEMP160J0T-LCL160	52000/62000	220-240V~1ph 50Hz	



## 2.2 Outdoor Units

Model Name	Power Supply (V, Ph, Hz)	Appearance
TCHB112J0T-LSL036 TCHB118J0T-LSL053	220-240V~1ph 50Hz	
TCHB124J0T-LSL070	220-240V~1ph 50Hz	
TCHB130J0T-LTL085	220-240V~1ph 50Hz	
TCHB136J0T-LTL105	220-240V~1ph 50Hz	
TCHB148J0T-LTL140	220-240V~1ph 50Hz	
TCHB160J7T-LTL160	380-415V~3ph 50Hz	

### 3. PRODUCT DATA

#### 3.1 Specifications Sheet

##### 3.1.1 Duct Type

model			TELP112J0T-LCL036	TELP118J0T-LCL053	TELP124J0T-LCL070	TEMP130J0T-LCL085
Indoor unit			TELP112J0T-LCL036	TELP118J0T-LCL053	TELP124J0T-LCL070	TEMP130J0T-LCL085
Outdoor unit			TCHB112J0T-LSL036	TCHB118J0T-LSL053	TCHB124J0T-LSL070	TCHB130J0T-LTL085
Type			heating pump	heating pump	heating pump	heating pump
Control type			wire controller	wire controller	wire controller	wire controller
Declared cooling capacity	btu/h		12860(2040~16600)	18000(2115~19050)	24000(7500~25500)	30000 (7600~32000)
Declared heating capacity	btu/h		13640(2380~18450)	19800(2600~20820)	26900(7900~28500)	32000 (9200~33200)
Declared cooling capacity	W		3770(600~4860)	5300(620~5580)	7030(2200~7500)	8800 (2230~9380)
Declared heating capacity	W		4000(700~5400)	5800(760~6100)	7900(2320~8350)	9380 (2700~9730)
Pdesignc	W		3770	5300	7030	8800
SEER declared	W/W		6.1	6.3	6.2	6.2
Energy Class			A++	A++	A++	A++
Pdesignh Average	W		4000	4300	5500	7400
SCOP Average declared	W/W		4.00	4.00	4.0	4.0
Energy Class(Average)			A+	A+	A+	A+
Declare capacity(-10℃)	W		3650	3650	4800	6450
Back up heating capacity(-10℃)	W		350	650	700	950
Annual energy consumption	Cooling	kwh/a	284	294	402	530
	Average	kwh/a	1475	1505	1925	2540
Moisture removal	Liters/h		1.5	1.5	2.00	2.60
Indoor sound power(S/H/M/L/Mute)	dB(A)		53/51/49/47/45	53/51/49/47/45	58/55/53/48/46	57/55/54/50/48
Indoor sound power(Standard rating conditions)	dB(A)		51	51	55	55
Outdoor sound power(Standard rating conditions)	dB(A)		62	62	64	66
Indoor sound pressure(S/H/M/L/Mute)	dB(A)		43/41/39/37/35	43/41/39/37/35	48/45/43/38/36	47/45/44/40/38
Indoor sound pressure(Standard rating conditions)	dB(A)		41	41	45	45
Outdoor sound pressure(Standard rating conditions)	dB(A)		52	52	54	56
Electrical Data						
Power supply			Indoor: 220-240V~/50Hz/1P Outdoor: 220-240V~/50Hz/1P	Indoor: 220-240V~/50Hz/1P Outdoor: 220-240V~/50Hz/1P	Indoor: 220-240V~/50Hz/1P Outdoor: 220-240V~/50Hz/1P	Indoor: 220-240V~/50Hz/1P Outdoor: 220-240V~/50Hz/1P
Power supply side			Outdoor	Outdoor	Outdoor	Outdoor
Voltage Range	V		176~265	176~265	176~265	176~265
Cooling Operating current	Indoor	A	0.6(0.2~1.0)	0.6(0.2~1.0)	1.3(0.2~1.4)	1.4(0.2~1.6)
	Outdoor	A	7.6(1.8~12.0)	7.6(1.8~12.0)	9.2(3.8~13.6)	10.7(3.8~14.9)
Heating Operating current	Indoor	A	0.6(0.2~1.0)	0.6(0.2~1.0)	1.3(0.2~1.4)	1.4(0.2~1.6)
	Outdoor	A	8.0(1.6~11)	8.0(1.6~11)	10.2(4.0~12.6)	11.7(4.0~13.9)
Cooling Power consumption	Indoor	W	70(20~110)	70(20~110)	150(20~165)	170(20~185)
	Outdoor	W	1160(395~2450)	1680(395~2740)	2290(710~3135)	2590(710~3415)
Heating Power consumption	Indoor	W	70(20~110)	70(20~110)	150(20~165)	170(20~185)
	Outdoor	W	1230(350~2150)	1820(350~2400)	2420(745~2935)	2720(745~3215)
Max. powerconsump	W		2850	2850	3300	3600

Max.current		A	13	13	15	16.5
Indoor fan motor	Indoor fan type		centrifugal fan	centrifugal fan	centrifugal fan	centrifugal fan
	Indoor air circulation Cooling/heating	m3/h	700/800	800/900	1350/1550	1600/1800
	Speed S/H/M/L/Mute	rpm	1220/1160/1070/950/850	1220/1160/1070/950/850	1050/900/800/700/660	1050/1000/950/850/770
Outdoor fan motor	Outdoor fan type		Propeller fan	Propeller fan	Propeller fan	Propeller fan
	Outdoor air circulation	m3/h	2650	2650	3500	4000
	Speed	rpm	770	770	880	950
Refrigerating System						
Refrigerant type/Charge/GWP/CO2 equivalent			R32/0.95kg/675/0.642tonnes	R32/0.95kg/675/0.642tonnes	R32/1.35kg/675/0.911tonnes	R32/1.4kg/675/0.945tonnes
Compressor	Type		Rotary	Rotary	Rotary	Rotary
	MFG		GMCC	GMCC	SANYO	SANYO
External Static Pressure(Rated )		Pa	25	25	25	37
External Static Pressure(Range )		Pa	0-60	0-60	0-80	0-120
Connections						
Connecting Wiring	Core x Size		outdoor: 3*2.5mm <sup>2</sup> ; outdoor to indoor: 5*1.5mm <sup>2</sup>	outdoor: 3*2.5mm <sup>2</sup> ; outdoor to indoor: 5*1.5mm <sup>2</sup>	outdoor: 3*2.5mm <sup>2</sup> ; outdoor to indoor: 5*1.5mm <sup>2</sup>	outdoor: 3*2.5mm <sup>2</sup> ; outdoor to indoor: 5*2.5mm <sup>2</sup>
Expansion device			Capillary +EXV	Capillary +EXV	Capillary +EXV	Capillary +EXV
Connecting Pipe	Gas	Inches	3/8"	3/8"	1/2"	5/8"
	Liquid	Inches	1/4"	1/4"	1/4"	3/8"
Others						
Application area		m <sup>2</sup>	20-35	20-35	27~45	35-60
Max. refrigerant pipe length		m	30	30	30	30
Max. difference in level		m	15	15	15	15
Operation temperature range		°C	16-31	16-31	16-31	16-31
Ambient temperature range	Outdoor	°C	Cooling:-15-58/Heating:-25-24	Cooling:-15-58/Heating:-25-24	Cooling:-15-58/Heating:-25-24	Cooling:-15-58/Heating:-25-24
	Indoor	°C	Cooling:17-32/Heating:0-30	Cooling:17-32/Heating:0-30	Cooling:17-32/Heating:0-30	Cooling:17-32/Heating:0-30
Net dimensions (W x H x D)	Indoor	mm	920×210×570	920×570×210	920×570×270	1140×710×270
	Outdoor	mm	780×605×307	780×605×307	845×700×342	845×700×342
Net weight	Indoor	kg	24	24	26	36
	Outdoor	kg	30	30	40	41
Packing dimensions (W x H x D)	Indoor	mm	1120×690×281	1120×690×281	1120×690×341	1341×830×341
	Outdoor	mm	890×385×648	890×648×385	960×430×755	960×430×755
Gross weight	Indoor	kg	28	28	31	41
	Outdoor	kg	33	33	44	45

model			TEMP136J0T-LCL105	TEMP148J0T-LCL140	TEMP160J0T-LCL160
Indoor unit			TEMP136J0T-LCL105	TEMP148J0T-LCL140	TEMP160J0T-LCL160
Outdoor unit			TCHB136J0T-LTL105	TCHB148J0T-LTL140	TCHB160J7T-LTL160
Type			heating pump	heating pump	heating pump
Control type			wire controller	wire controller	wire controller
Declared cooling capacity	btu/h		36000(10500~42000)	48000(12000~53000)	55000(14000~59000)
Declared heating capacity	btu/h		40000(11200~46000)	55000(14000~62000)	62000(15000~70000)
Declared cooling capacity	W		10550(3080~12300)	14070(3520~15530)	16000(4100~17290)
Declared heating capacity	W		11720(3280~13500)	16120(4100~18170)	18170(4400~20520)
Pdesignc	W		10550	14000	16000
SEER declared	W/W		6.1	6.1	6.1
Energy Class			A++	A++	A++
Pdesignh Average	W		8500	11800	11900
SCOP Average declared	W/W		4.3	4.0	4.0
Energy Class(Average)			A+	A+	A+
Declare capacity(-10℃)	W		7650	8800	10290
Back up heating capacity(-10℃)	W		850	3000	1610
Annual energy consumption	Cooling	kwh/a	605	800	949
	Average	kwh/a	2625	4200	4235
Moisture removal	Liters/h		3.60	4.80	5.40
Indoor sound power(S/H/M/L/Mute)	dB(A)		62/59/57/55/54	63/61/59/57/55	63/62/60/58/56
Indoor sound power(Standard rating conditions)	dB(A)		59	61	62
Outdoor sound power(Standard rating conditions)	dB(A)		67	70	68
Indoor sound pressure(S/H/M/L/Mute)	dB(A)		52/49/47/45/44	53/51/49/47/45	53/52/50/48/46
Indoor sound pressure(Standard rating conditions)	dB(A)		49	51	52
Outdoor sound pressure(Standard rating conditions)	dB(A)		57	60	58
Electrical Data					
Power supply			Indoor: 220-240V~/50Hz/1P Outdoor: 220-240V~/50Hz/1P	Indoor: 220-240V~/50Hz/1P Outdoor: 380~415V~/50Hz/3P	Indoor: 220-240V~/50Hz/1P Outdoor: 380~415V/50Hz/3P
Power supply side			Outdoor	Outdoor	Outdoor
Voltage Range		V	176~265	Indoor: 176~265 Outdoor: 304~458	Indoor: 176~265 Outdoor: 304~458
Cooling Operating current	Indoor	A	1.1(0.4~1.3)	1.2 (0.5~1.6)	1.9(0.6~2.2)
	Outdoor	A	15.1(0.8~19.7)	7.2(1.7~10.4)	9.3(2.0~11.0)
Heating Operating current	Indoor	A	1.1(0.4~1.3)	1.2(0.5~1.6)	1.9(0.6~2.2)
	Outdoor	A	15.1(1.2~16.1)	7.3(1.5~10.4)	9.1(1.7~11.0)
Cooling Power consumption	Indoor	W	250(80~280)	340(70~450)	400(60~590)
	Outdoor	W	3300(170~4320)	4760(890~6060)	6060(1090~6510)
Heating Power consumption	Indoor	W	250(80~280)	340(70~450)	400(60~590)
	Outdoor	W	3300(270~3520)	4760(810~6550)	6250(880~6950)
Max. powercon sump		W	4600	7000	7000
Max.current		A	21	12.0	12.0
Indoor fan motor	Indoor fan type		centrifugal fan	centrifugal fan	centrifugal fan
	Indoor air circulation Cooling/heating	m3/h	1900/2000	2300/2300	2300/2500

	Speed S/H/M/L/M ute	rpm	1200/1050/1000/950/850	1300/1200/1100/1050/1000	1350/1270/1190/1110/1030
Outdoor fan motor	Outdoor fan type		Propeller fan	Propeller fan	Propeller fan
	Outdoor air circulation	m <sup>3</sup> /h	5000	5600	6000
	Speed	rpm	930	700	720
Refrigeratin g System					
Refrigerant type/Charge/GWP/CO2 equivalent			R32/2.10kg/675/1.418tonnes	R32/1.90kg/675/1.283tonnes	R32/2.60kg/675/1.755tonnes
Compressor	Type		Rotary	Rotary	Rotary
	MFG		GMCC	SANYO	HIGHLY
External Static Pressure(Rated )		Pa	37	50	50
External Static Pressure(Range )		Pa	0-120	0-120	0-120
Connections					
Connecting Wiring	Core x Size		outdoor: 3*2.5mm <sup>2</sup> ; outdoor to indoor: 3*1.5mm <sup>2</sup> +3*0.75	Outdoor: 5*2.5mm <sup>2</sup> outdoor to indoor: 3*1.0mm <sup>2</sup> +3*0.75	Outdoor: 5*2.5mm <sup>2</sup> outdoor to indoor: 3*1.0mm <sup>2</sup> +3*0.75
Expension device			Capillary +EXV	EXV	EXV
Connecting Pipe	Gas	Inche s	5/8"	5/8"	5/8"
	Liquid	Inche s	3/8"	3/8"	3/8"
Others					
Application area		m <sup>2</sup>	39~71	50~95	55~105
Max. refrigerant pipe length		m	50	60	60
Max. difference in level		m	25	30	30
Operation temperature range		℃	16-31	16-31	16-31
Ambient temperature range	Outdoor	℃	Cooling:-15-58/Heating:-25-24	Cooling:-15-58/Heating:- 25-24	Cooling:-15-58/Heating:- 25-24
	Indoor	℃	Cooling:17-32/Heating:0-30	Cooling:17-32/Heating:0- 30	Cooling:17-32/Heating:0- 30
Net dimensions (W x H x D)	Indoor	mm	1140×710×270	1400×720×250	1400×720×250
	Outdoor	mm	910×804×378	1010×858×436	1010×858×436
Net weight	Indoor	kg	36	38	38
	Outdoor	kg	55	77	83
Packing dimensions (W x H x D)	Indoor	mm	1341×830×341	1632×827×298	1632×827×298
	Outdoor	mm	1022×860×480	1135×970×530	1135×970×530
Gross weight	Indoor	kg	41	43	43
	Outdoor	kg	60	89	95

### 3.2 The curve of Static Pressure(Duct Type)

TELP112(118)J0T

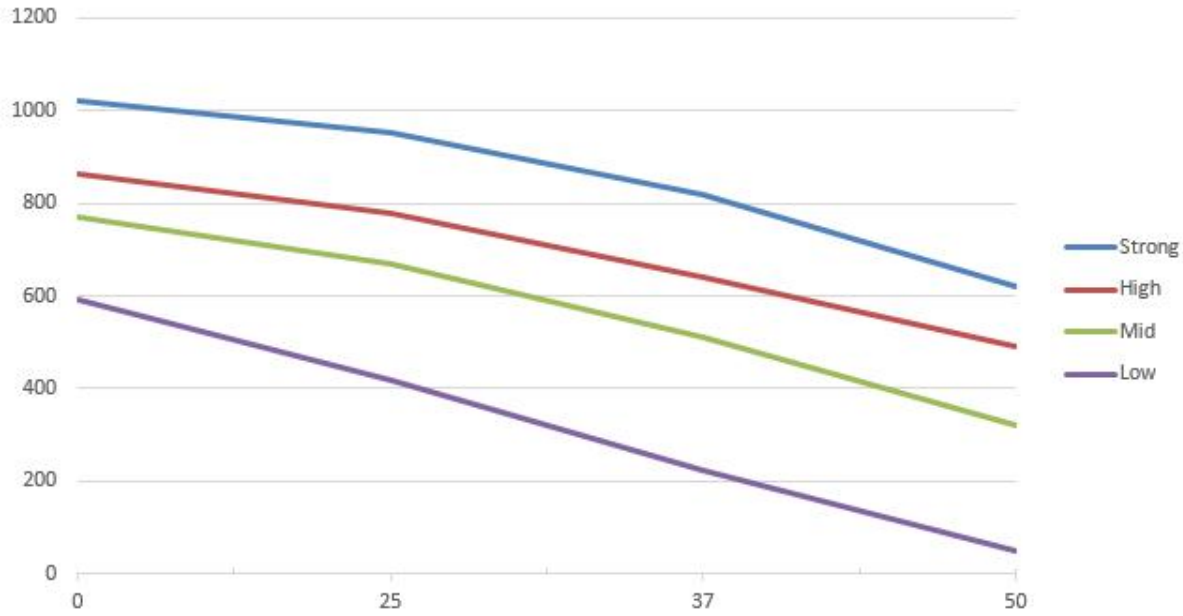

TELP124J0T-LCL070

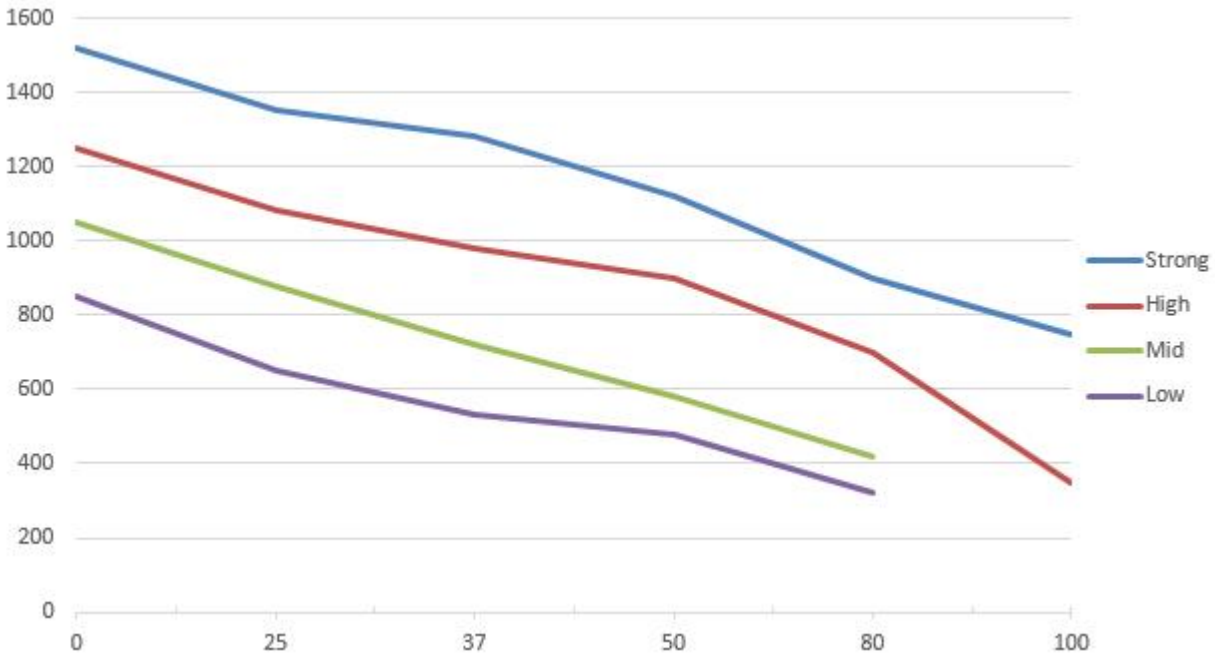

TEMP130J0T-LCL085

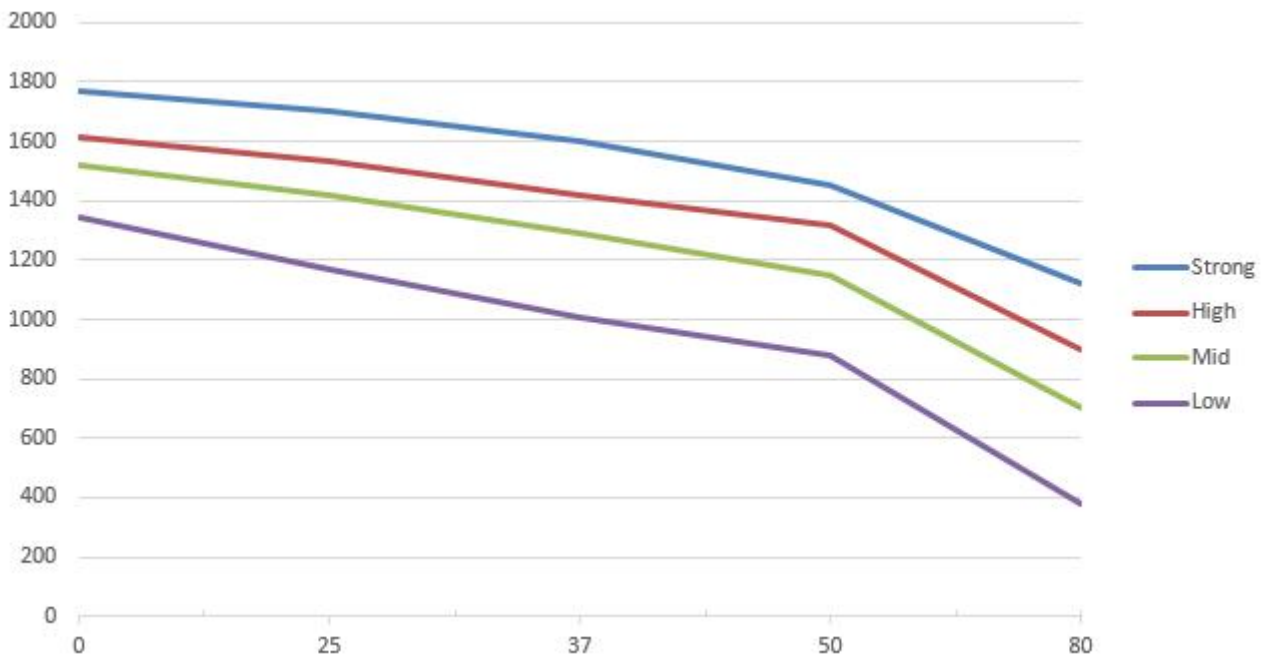

TEMP136J0T-LCL105

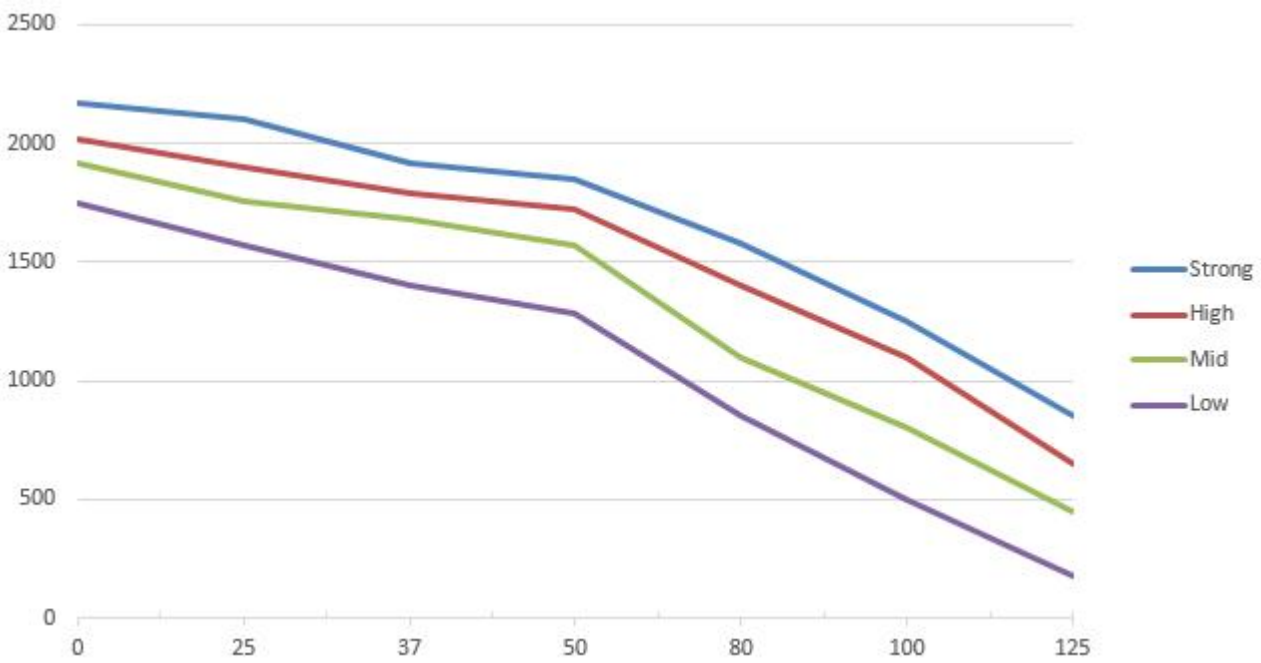

TEMP148J0T-LCL140

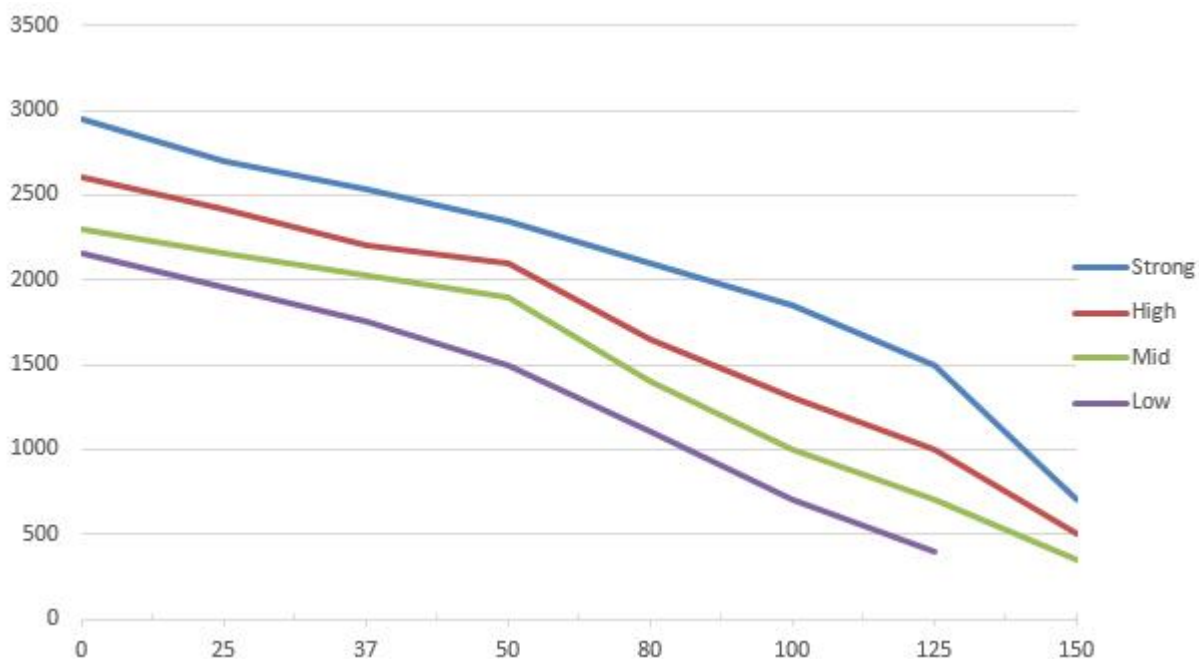

TEMP160J0T-LCL160

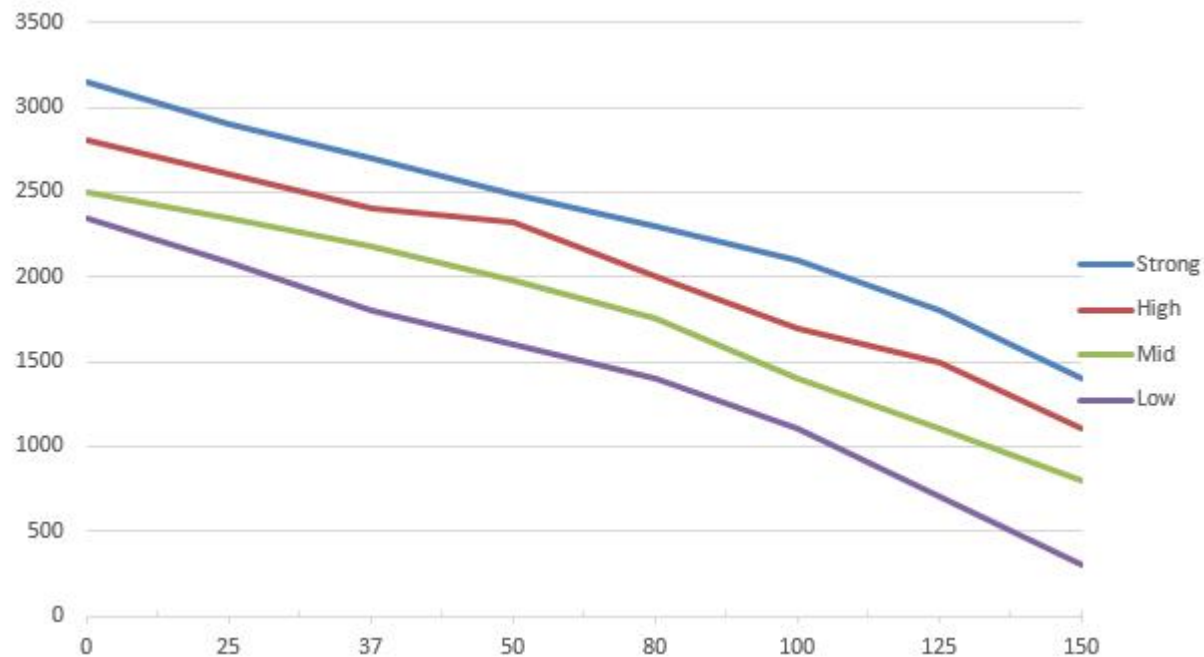



### 3.3 Guidelines for static pressure regulation

Capacity (duct)	Dip switches on the wiring diagram	Static pressure value at the factory	Static pressure at 01 speed	Static pressure at 02 speed	Static pressure at 03 speed	Static pressure at 04 speed
18K	SW2_3, SW2_4 FAN SELECTION	25	20-40Pa	0-10	10-20Pa	40-60Pa
24K	STATIC PRESSURE-01 (FACTORY DEFAULT)	25	20-40Pa	0-10	10-20Pa	40-80Pa
30K	STATIC PRESSURE-02	37	35-70Pa	0-20	20-35Pa	70-120Pa
36K	STATIC PRESSURE-03	37	35-70Pa	0-20	20-35Pa	70-120Pa
42K	STATIC PRESSURE-04	50	50-70Pa	0-30	30-50Pa	70-120Pa
48K	STATIC PRESSURE-01	50	50-70Pa	0-30	30-50Pa	70-120Pa
55K	STATIC PRESSURE-02	50	50-70Pa	0-30	30-50Pa	70-120Pa

### 3.4 Sound Levels

#### 3.4.1 Duct Type

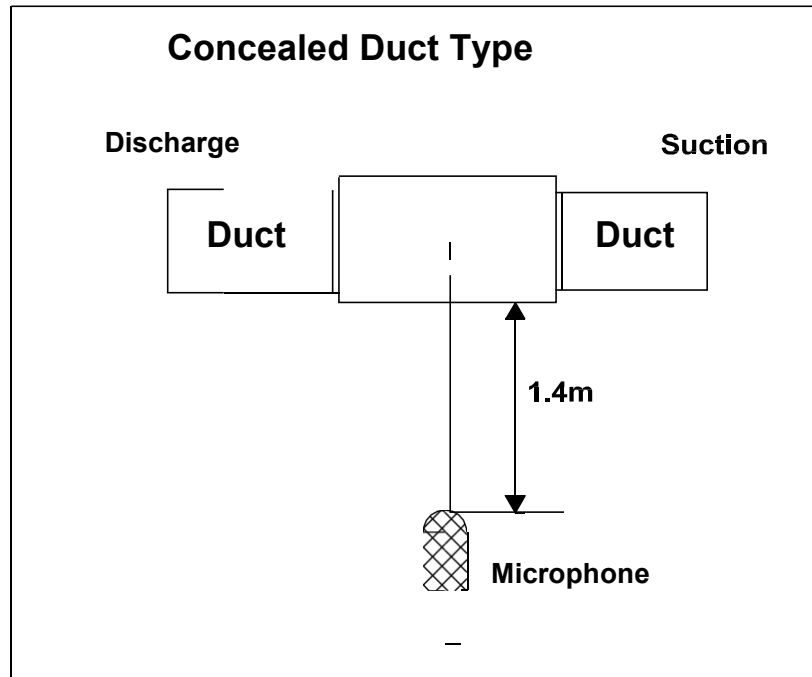

Model	Sound Power dB(A)					Sound Pressure dB(A)				
	S	H	M	L	Mute	S	H	M	L	Mute
TELP118J0T-LCL053	53	51	49	47	45	43	41	39	37	35
TELP124J0T-LCL070	58	55	53	48	46	48	45	43	38	36
TEMP130J0T-LCL085	60	58	56	53	52	50	48	46	43	42
TEMP136J0T-LCL105	62	59	57	55	54	52	49	47	45	44
TEMP142J0T-LCL125	62	59	57	55	54	52	49	47	45	44
TEMP148J0T-LCL140	64	62	60	58	56	54	52	50	48	46
TEMP160J0T-LCL160	65	63	61	59	58	55	53	51	49	48

### 3.5 Operation Limits

Mode Temperature	Cooling operation	Heating operation	Drying operation
Room temperature	17°C~32°C	0°C~27°C	17°C~32°C
Outdoor temperature	0°C~50°C	-15°C~24°C	0°C~50°C
	(-15°C~50°C: For the models with low temperature cooling system)		

#### CAUTION:

1. If the air conditioner is used beyond the above conditions, certain safety protection features may come into operation and cause the unit to operate abnormally.
2. The room relative humidity should be less than 80%. If the air conditioner operates beyond this figure, the surface of the air conditioner may attract condensation. Please set the vertical air flow louver to its maximum angle (vertically to the floor), and set HIGH fan mode.
3. The optimum performance will be achieved during this operating temperature zone.

### 3.6 Product Dimensions

#### 3.6.1 Duct Type

The positioning of ceiling hole, indoor unit and hanging screw bolts.

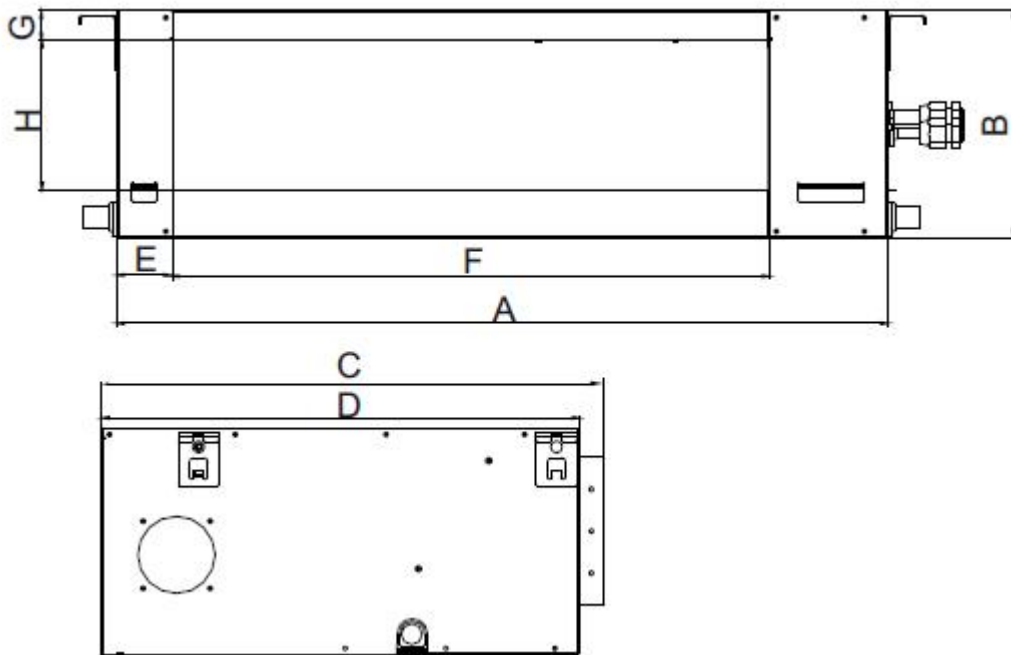

Position size of descensional ventilation opening

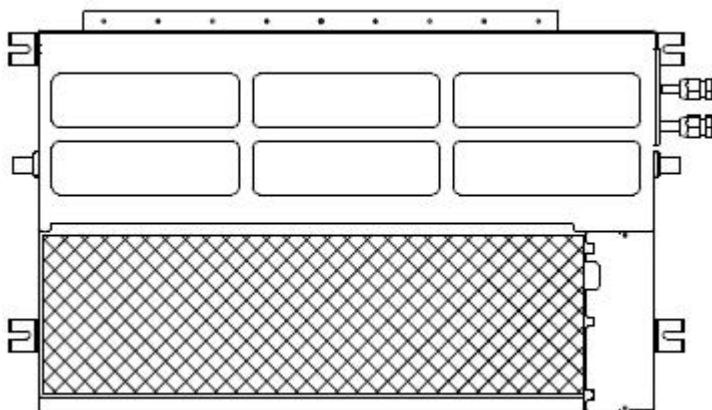

Air inlet size

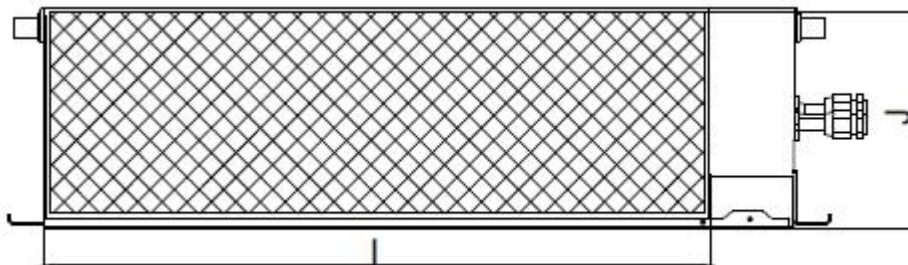

Size of mounted hook

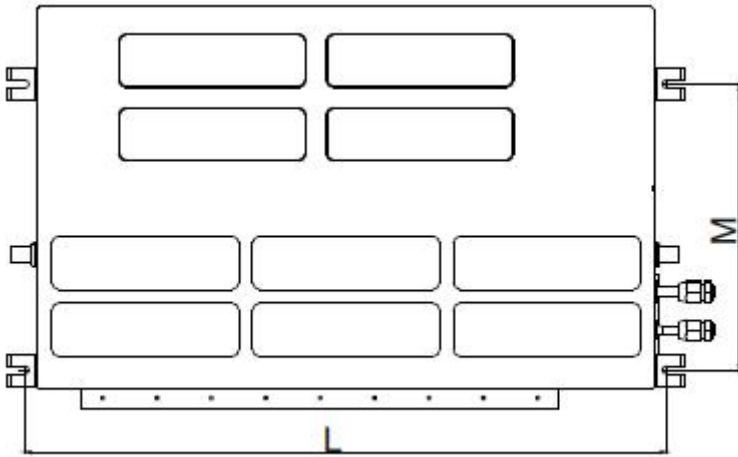

Capacity	Outline dimension				Air outlet opening size				Air inlet opening size			Size of mounted lug	
	A	B	C	D	E	F	G	H	I	J	K	L	M
TELP112(118)J0T	920	2100	635	570	65	713	35	119	815	197	36	958	427
TELP124J0T-LCL070	920	2700	635	570	65	713	35	179	815	260	36	958	427
TEMP130(136)J0T	1140	270	775	710	65	933	37	175	1034	260	36	1178	541
TEMP148(160)J0T	1400	250	720	700	150	1350	15	170	1300	220	20	1440	650

### 3.6.4 Outdoor Units

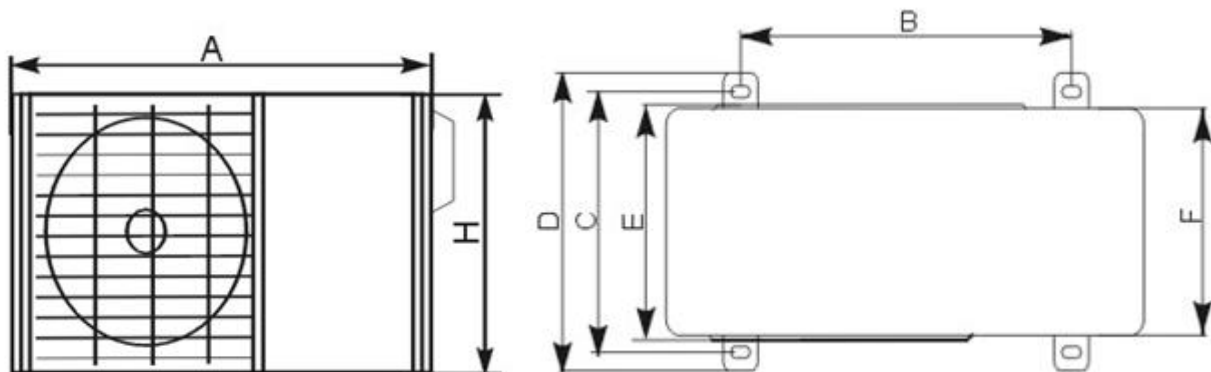

MODE	A	B	C	D	E	F	H
TCHB112(118)J0T	780	516	314	350	321	307	605
TCHB124(130)J0T	845	574	348	375	358	342	700
TCHB136J0T-LTL105	910	607	390	421	387	375	804
TCHB148(160)J0T	1010	660	462	494	440	436	858

### 3.7 Wiring Diagram

#### Duct Type

MODEL : TCHB112(118,124,130)J0T:

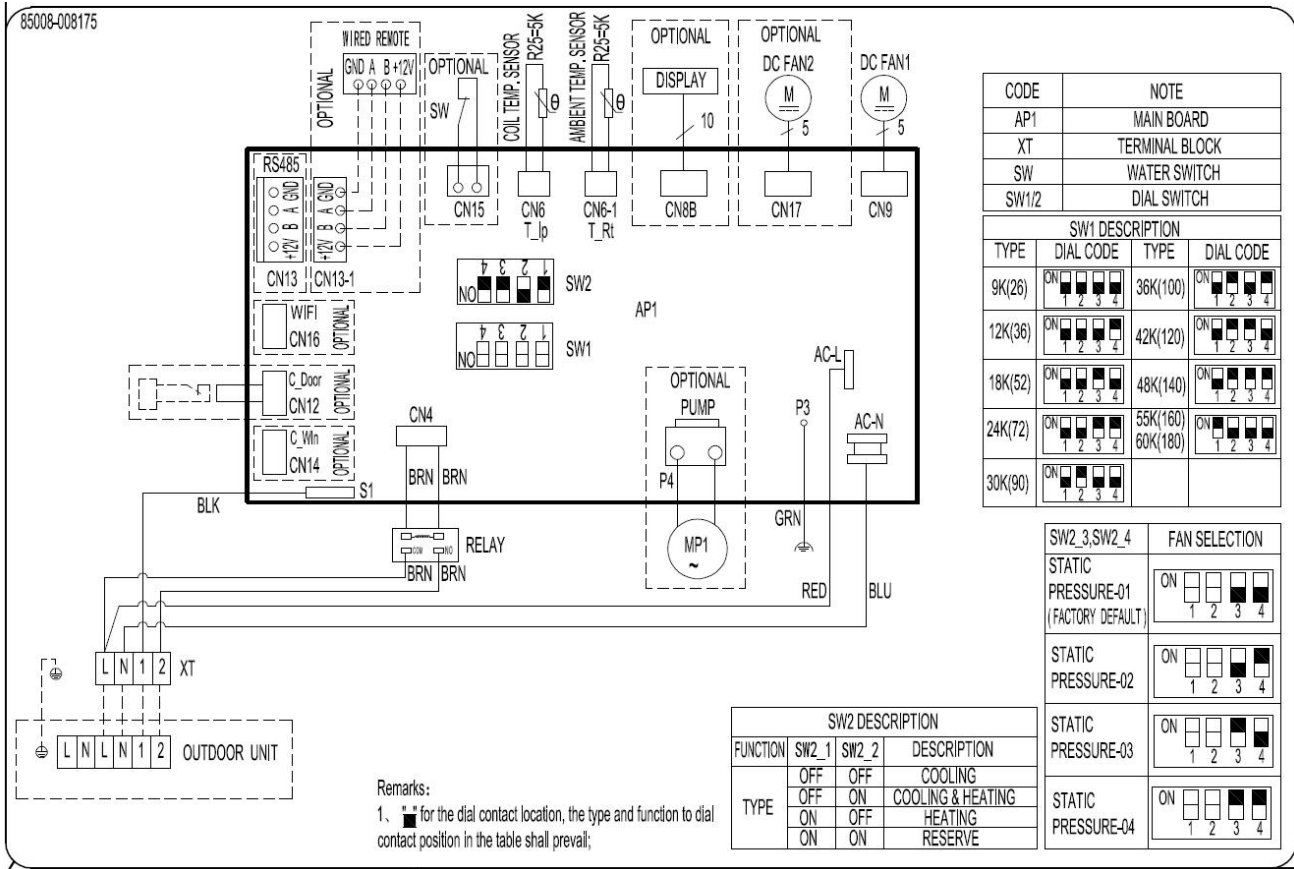

CODE	NOTE
AP1	MAIN BOARD
XT	TERMINAL BLOCK
SW	WATER SWITCH
SW1/2	DIAL SWITCH

SW1 DESCRIPTION			
TYPE	DIAL CODE	TYPE	DIAL CODE
9K(26)	<input type="checkbox"/> 1 <input type="checkbox"/> 2 <input type="checkbox"/> 3 <input type="checkbox"/> 4	36K(100)	<input type="checkbox"/> 1 <input type="checkbox"/> 2 <input type="checkbox"/> 3 <input type="checkbox"/> 4
12K(36)	<input type="checkbox"/> 1 <input type="checkbox"/> 2 <input type="checkbox"/> 3 <input type="checkbox"/> 4	42K(120)	<input type="checkbox"/> 1 <input type="checkbox"/> 2 <input type="checkbox"/> 3 <input type="checkbox"/> 4
18K(52)	<input type="checkbox"/> 1 <input type="checkbox"/> 2 <input type="checkbox"/> 3 <input type="checkbox"/> 4	48K(140)	<input type="checkbox"/> 1 <input type="checkbox"/> 2 <input type="checkbox"/> 3 <input type="checkbox"/> 4
24K(72)	<input type="checkbox"/> 1 <input type="checkbox"/> 2 <input type="checkbox"/> 3 <input type="checkbox"/> 4	55K(160)	<input type="checkbox"/> 1 <input type="checkbox"/> 2 <input type="checkbox"/> 3 <input type="checkbox"/> 4
30K(90)	<input type="checkbox"/> 1 <input type="checkbox"/> 2 <input type="checkbox"/> 3 <input type="checkbox"/> 4	60K(180)	<input type="checkbox"/> 1 <input type="checkbox"/> 2 <input type="checkbox"/> 3 <input type="checkbox"/> 4

SW2_3, SW2_4		FAN SELECTION	
STATIC PRESSURE-01 (FACTORY DEFAULT)	<input type="checkbox"/> 1 <input type="checkbox"/> 2 <input type="checkbox"/> 3 <input type="checkbox"/> 4	ON	<input type="checkbox"/> 1 <input type="checkbox"/> 2 <input type="checkbox"/> 3 <input type="checkbox"/> 4
STATIC PRESSURE-02	<input type="checkbox"/> 1 <input type="checkbox"/> 2 <input type="checkbox"/> 3 <input type="checkbox"/> 4	ON	<input type="checkbox"/> 1 <input type="checkbox"/> 2 <input type="checkbox"/> 3 <input type="checkbox"/> 4
STATIC PRESSURE-03	<input type="checkbox"/> 1 <input type="checkbox"/> 2 <input type="checkbox"/> 3 <input type="checkbox"/> 4	ON	<input type="checkbox"/> 1 <input type="checkbox"/> 2 <input type="checkbox"/> 3 <input type="checkbox"/> 4
STATIC PRESSURE-04	<input type="checkbox"/> 1 <input type="checkbox"/> 2 <input type="checkbox"/> 3 <input type="checkbox"/> 4	ON	<input type="checkbox"/> 1 <input type="checkbox"/> 2 <input type="checkbox"/> 3 <input type="checkbox"/> 4

SW2 DESCRIPTION			
FUNCTION	SW2_1	SW2_2	DESCRIPTION
TYPE	OFF	OFF	COOLING
	OFF	ON	COOLING & HEATING
	ON	OFF	HEATING
	ON	ON	RESERVE

Remarks:  
 1.  for the dial contact location, the type and function to dial contact position in the table shall prevail;

**MODEL : TCHB136J0T-LTL105:**

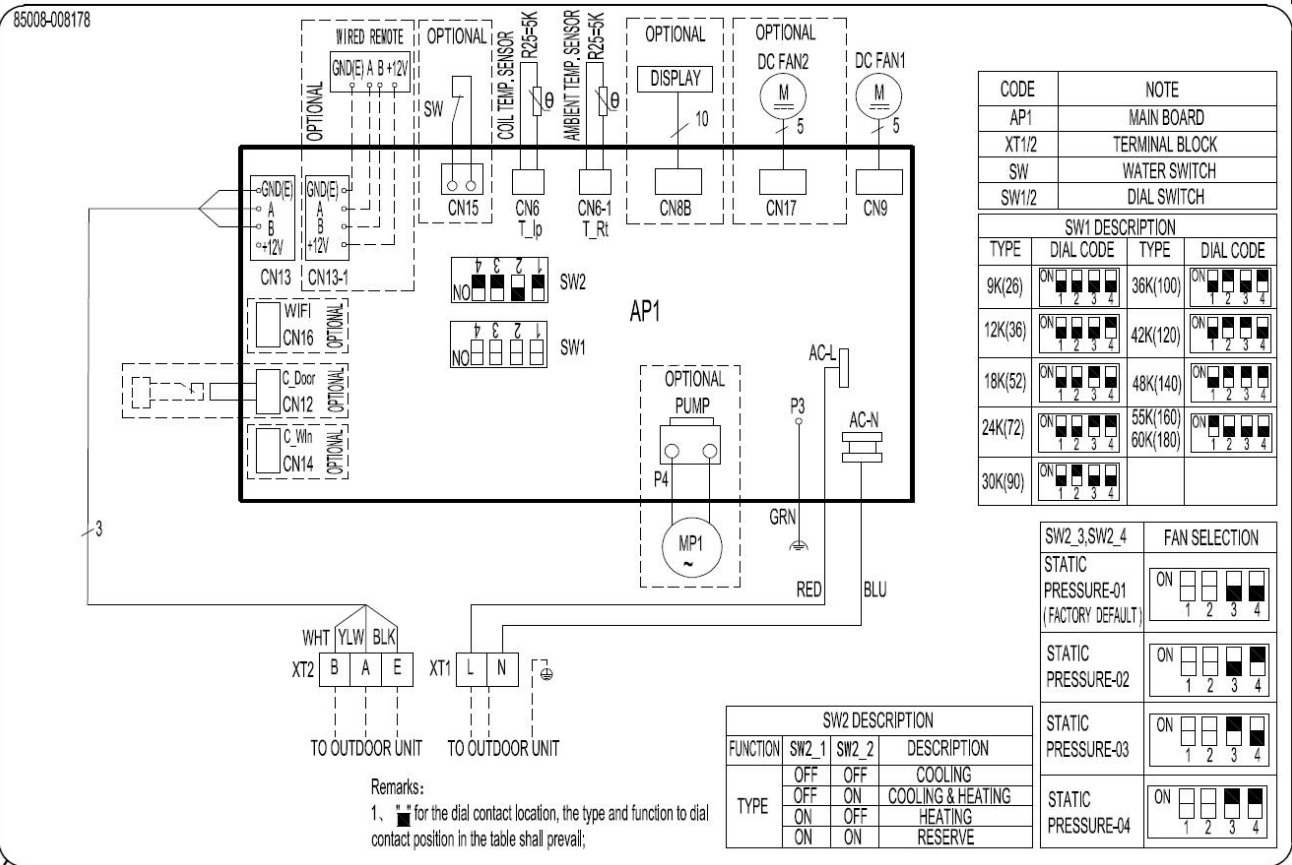

**TCHB160J7T-LTL160--Three phases unit**

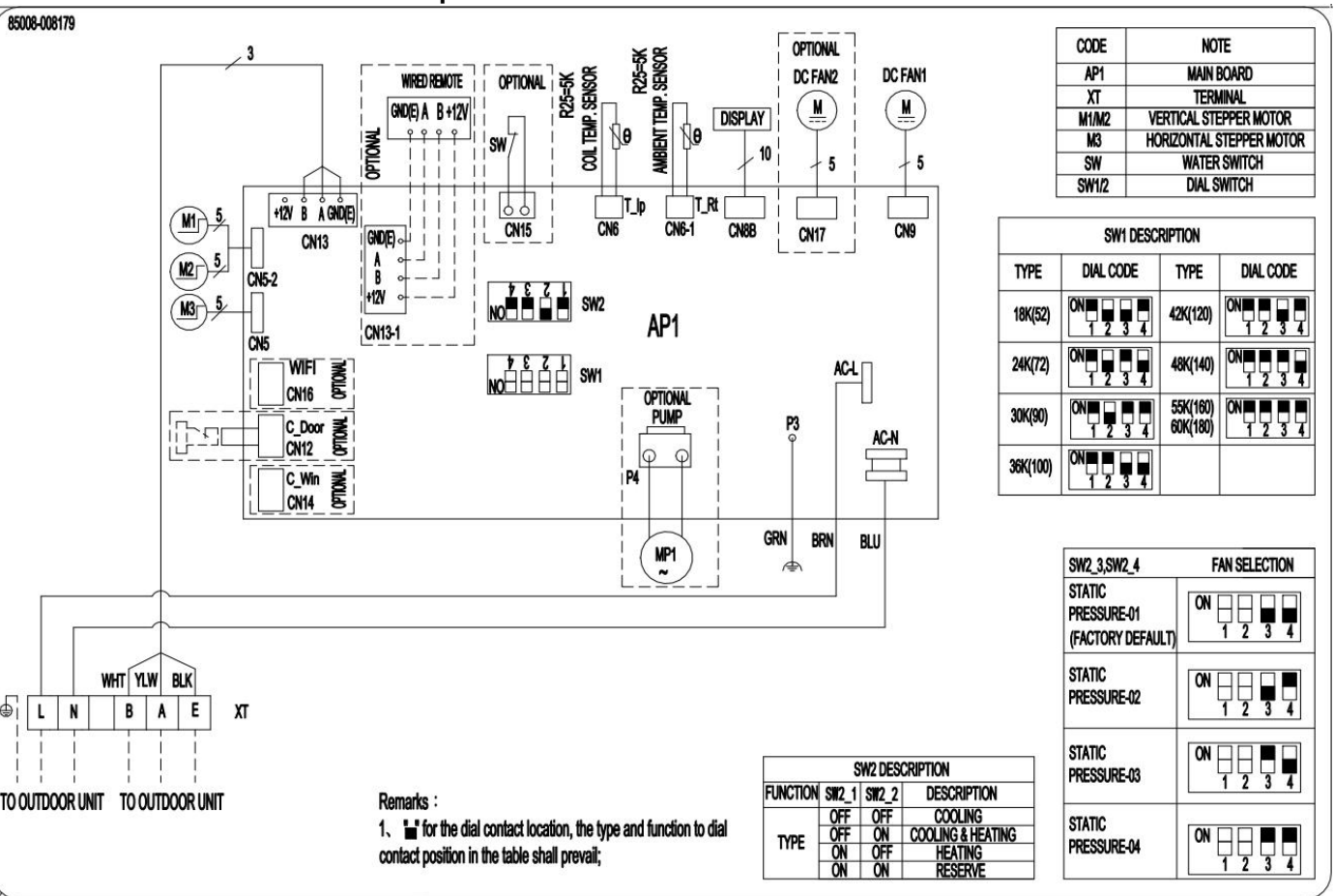

**Micro-Switch Introduce:**

Sw1 is for selection of type, sw2 is for selection of function, see the below table.

SW1 DESCRIPTION			
TYPE	DIAL CODE	TYPE	DIAL CODE
9K(26)	ON <input type="checkbox"/> <input type="checkbox"/> <input type="checkbox"/> <input type="checkbox"/> 1 2 3 4	36K(100)	ON <input type="checkbox"/> <input type="checkbox"/> <input type="checkbox"/> <input type="checkbox"/> 1 2 3 4
12K(36)	ON <input type="checkbox"/> <input type="checkbox"/> <input type="checkbox"/> <input type="checkbox"/> 1 2 3 4	42K(120)	ON <input type="checkbox"/> <input type="checkbox"/> <input type="checkbox"/> <input type="checkbox"/> 1 2 3 4
18K(52)	ON <input type="checkbox"/> <input type="checkbox"/> <input type="checkbox"/> <input type="checkbox"/> 1 2 3 4	48K(140)	ON <input type="checkbox"/> <input type="checkbox"/> <input type="checkbox"/> <input type="checkbox"/> 1 2 3 4
24K(72)	ON <input type="checkbox"/> <input type="checkbox"/> <input type="checkbox"/> <input type="checkbox"/> 1 2 3 4	55K(160) 60K(180)	ON <input type="checkbox"/> <input type="checkbox"/> <input type="checkbox"/> <input type="checkbox"/> 1 2 3 4
30K(90)	ON <input type="checkbox"/> <input type="checkbox"/> <input type="checkbox"/> <input type="checkbox"/> 1 2 3 4		

SW1 DESCRIPTION			
TYPE	DIAL CODE	TYPE	DIAL CODE
9K(26)	ON <input type="checkbox"/> <input type="checkbox"/> <input type="checkbox"/> <input type="checkbox"/> 1 2 3 4	36K(100)	ON <input type="checkbox"/> <input type="checkbox"/> <input type="checkbox"/> <input type="checkbox"/> 1 2 3 4
12K(36)	ON <input type="checkbox"/> <input type="checkbox"/> <input type="checkbox"/> <input type="checkbox"/> 1 2 3 4	42K(120)	ON <input type="checkbox"/> <input type="checkbox"/> <input type="checkbox"/> <input type="checkbox"/> 1 2 3 4
18K(52)	ON <input type="checkbox"/> <input type="checkbox"/> <input type="checkbox"/> <input type="checkbox"/> 1 2 3 4	48K(140)	ON <input type="checkbox"/> <input type="checkbox"/> <input type="checkbox"/> <input type="checkbox"/> 1 2 3 4
24K(72)	ON <input type="checkbox"/> <input type="checkbox"/> <input type="checkbox"/> <input type="checkbox"/> 1 2 3 4	55K(160) 60K(180)	ON <input type="checkbox"/> <input type="checkbox"/> <input type="checkbox"/> <input type="checkbox"/> 1 2 3 4
30K(90)	ON <input type="checkbox"/> <input type="checkbox"/> <input type="checkbox"/> <input type="checkbox"/> 1 2 3 4		

SW1 DESCRIPTION			
TYPE	DIAL CODE	TYPE	DIAL CODE
9K(26)	ON <input type="checkbox"/> <input type="checkbox"/> <input type="checkbox"/> <input type="checkbox"/> 1 2 3 4	36K(100)	ON <input type="checkbox"/> <input type="checkbox"/> <input type="checkbox"/> <input type="checkbox"/> 1 2 3 4
12K(36)	ON <input type="checkbox"/> <input type="checkbox"/> <input type="checkbox"/> <input type="checkbox"/> 1 2 3 4	42K(120)	ON <input type="checkbox"/> <input type="checkbox"/> <input type="checkbox"/> <input type="checkbox"/> 1 2 3 4
18K(52)	ON <input type="checkbox"/> <input type="checkbox"/> <input type="checkbox"/> <input type="checkbox"/> 1 2 3 4	48K(140)	ON <input type="checkbox"/> <input type="checkbox"/> <input type="checkbox"/> <input type="checkbox"/> 1 2 3 4
24K(72)	ON <input type="checkbox"/> <input type="checkbox"/> <input type="checkbox"/> <input type="checkbox"/> 1 2 3 4	55K(160) 60K(180)	ON <input type="checkbox"/> <input type="checkbox"/> <input type="checkbox"/> <input type="checkbox"/> 1 2 3 4
30K(90)	ON <input type="checkbox"/> <input type="checkbox"/> <input type="checkbox"/> <input type="checkbox"/> 1 2 3 4		

Sw1 is for selection of type, sw2 is for selection of function, see the below table.

SW2 DESCRIPTION			
FUNCTION	SW2_1	SW2_2	DESCRIPTION
TYPE	OFF	OFF	COOLING
	OFF	ON	COOLING & HEATING
	ON	OFF	HEATING
	ON	ON	RESERVE

SW2_3,SW2_4	FAN SELECTION
STATIC PRESSURE-01 (FACTORY DEFAULT)	ON <input type="checkbox"/> <input type="checkbox"/> <input checked="" type="checkbox"/> <input type="checkbox"/> 1 2 3 4
STATIC PRESSURE-02	ON <input type="checkbox"/> <input type="checkbox"/> <input checked="" type="checkbox"/> <input type="checkbox"/> 1 2 3 4
STATIC PRESSURE-03	ON <input type="checkbox"/> <input type="checkbox"/> <input checked="" type="checkbox"/> <input checked="" type="checkbox"/> 1 2 3 4
STATIC PRESSURE-04	ON <input type="checkbox"/> <input type="checkbox"/> <input checked="" type="checkbox"/> <input checked="" type="checkbox"/> 1 2 3 4

**3.7.2 OUTDOOR UNIT**  
**MODEL: TCHB112(118,124,130)J0T**

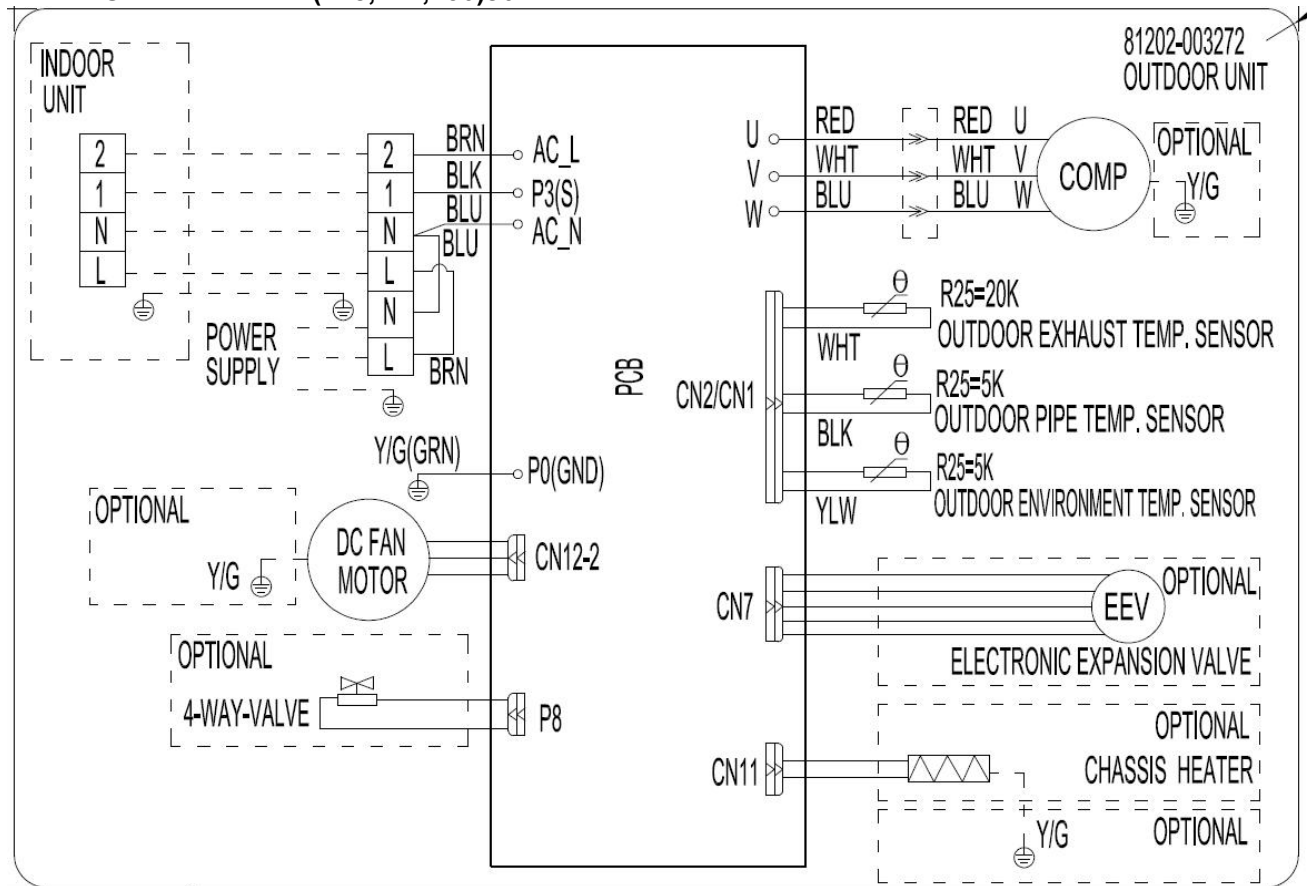

**MODEL: TCHB136J0T-LTL105 (Single-Phase)**

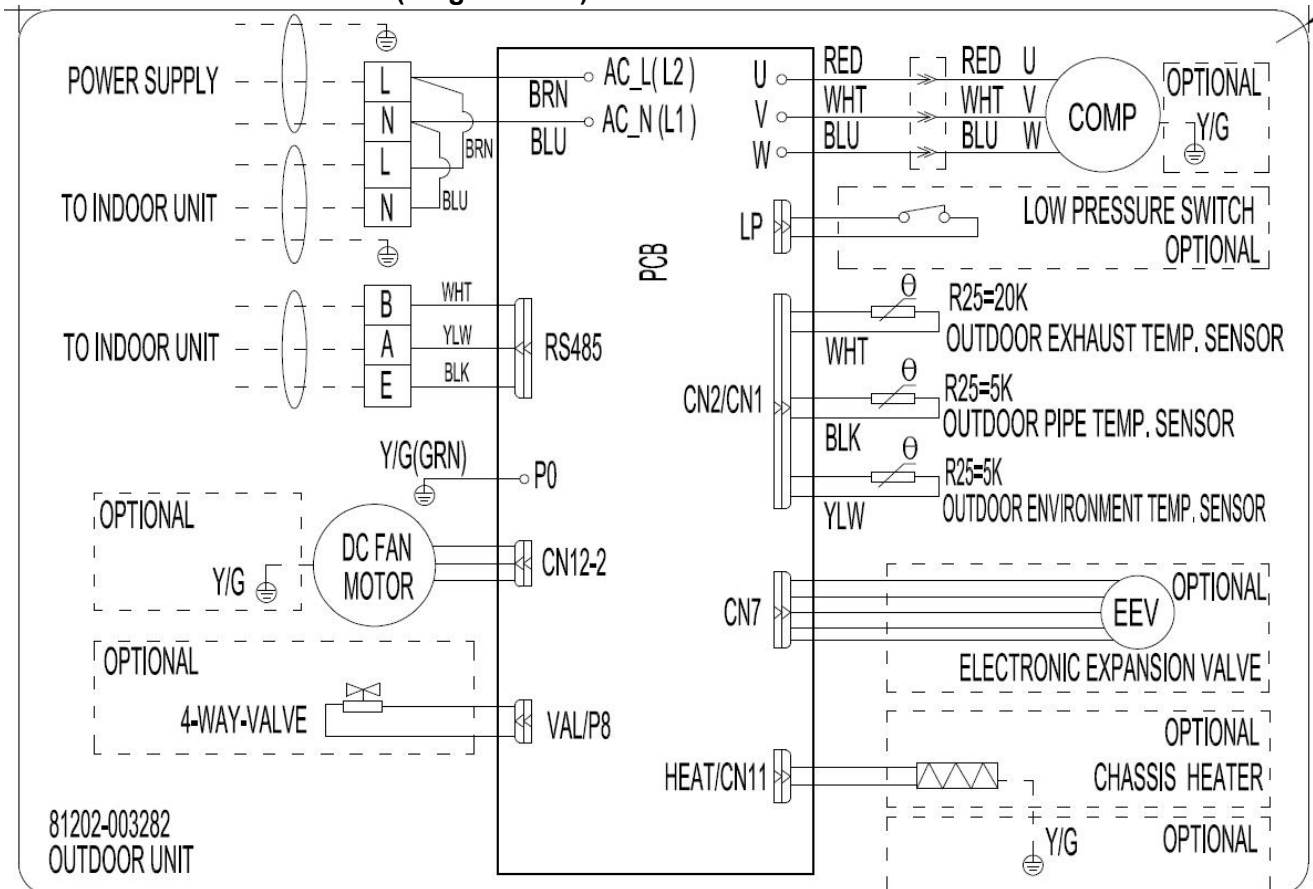



TCHB160J7T-LTL160 three-phase models.

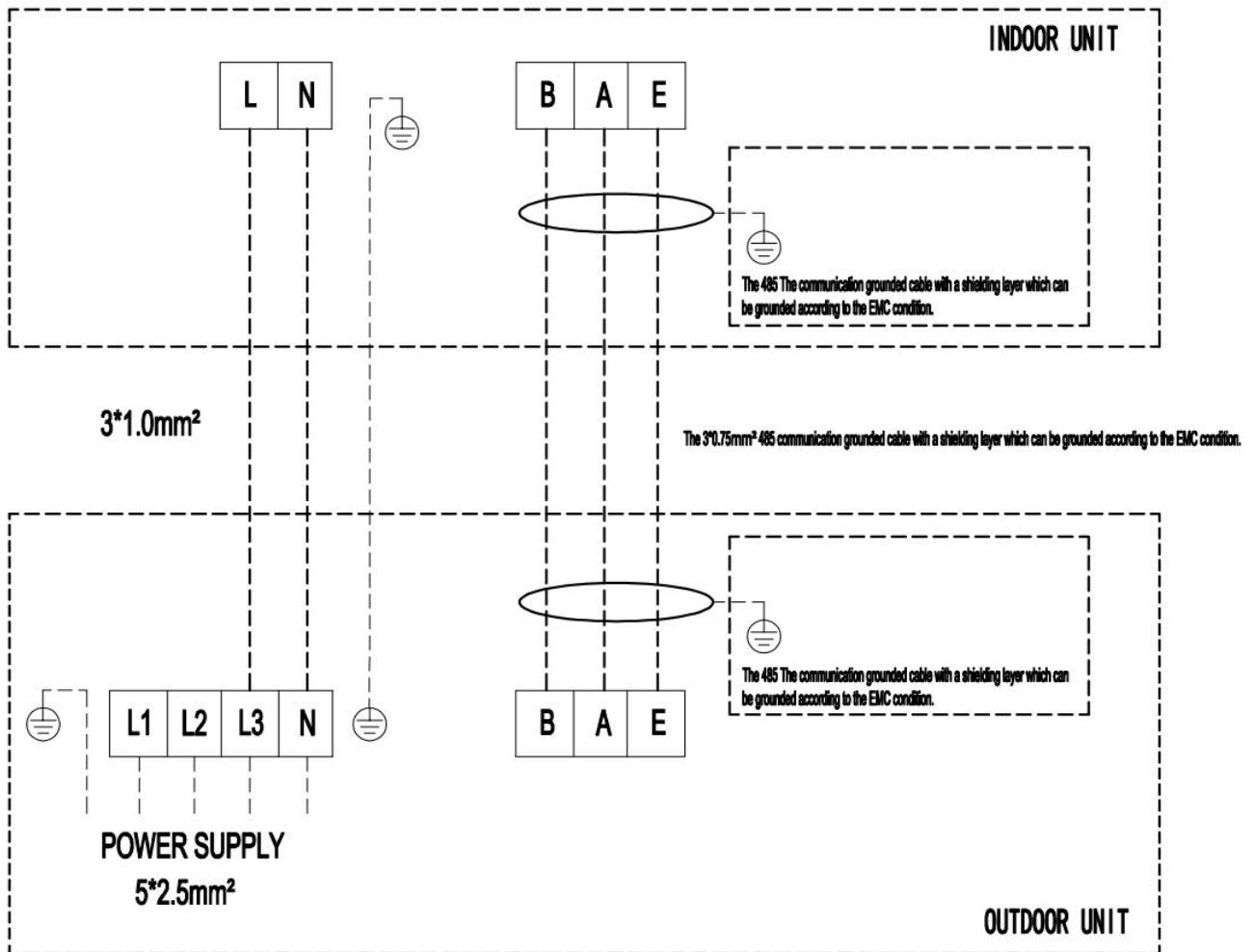



### 3.8.2 Outdoor Units

#### TCHB112(118)J0T

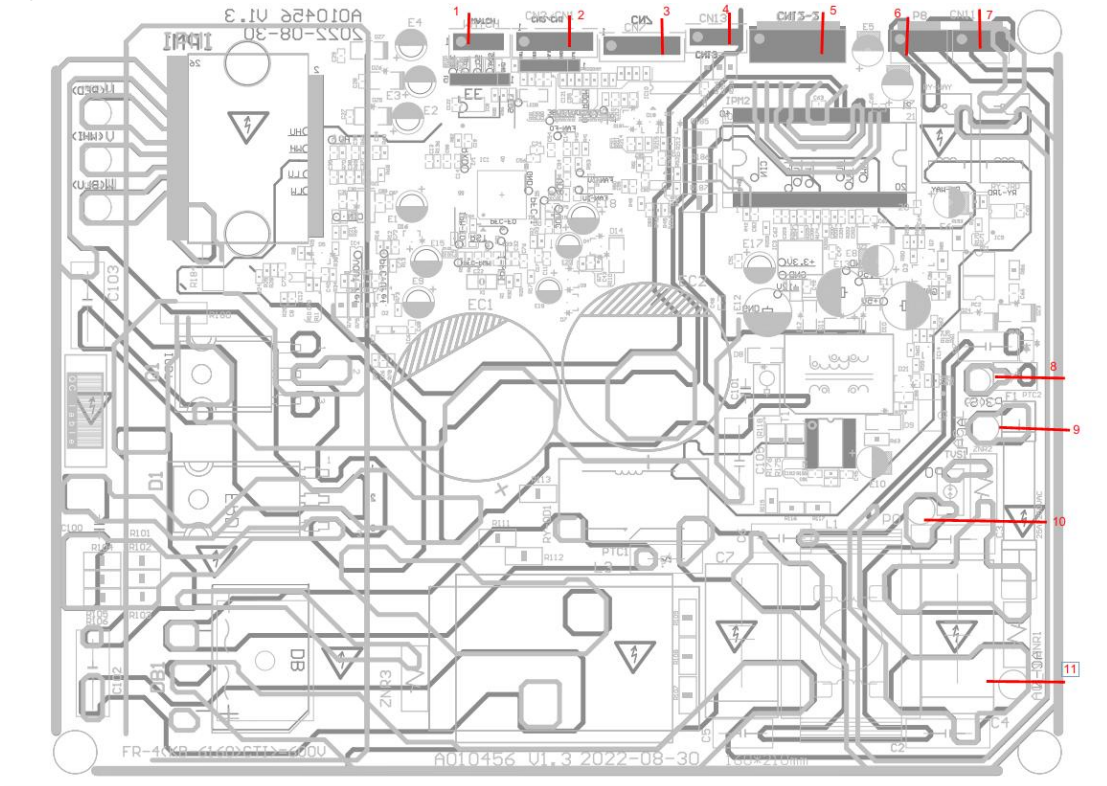

1	Reserved	7	Compressor crankcase electric heating belt
2	Outdoor temperature sensor	8	Communication line
3	Electronic expansion valve	9	Live wire input
4	Reserved	10	Ground wire
5	DC fan motor output	11	Neutral wire input
6	Four-way valve		

#### TCHB124(130)J0T

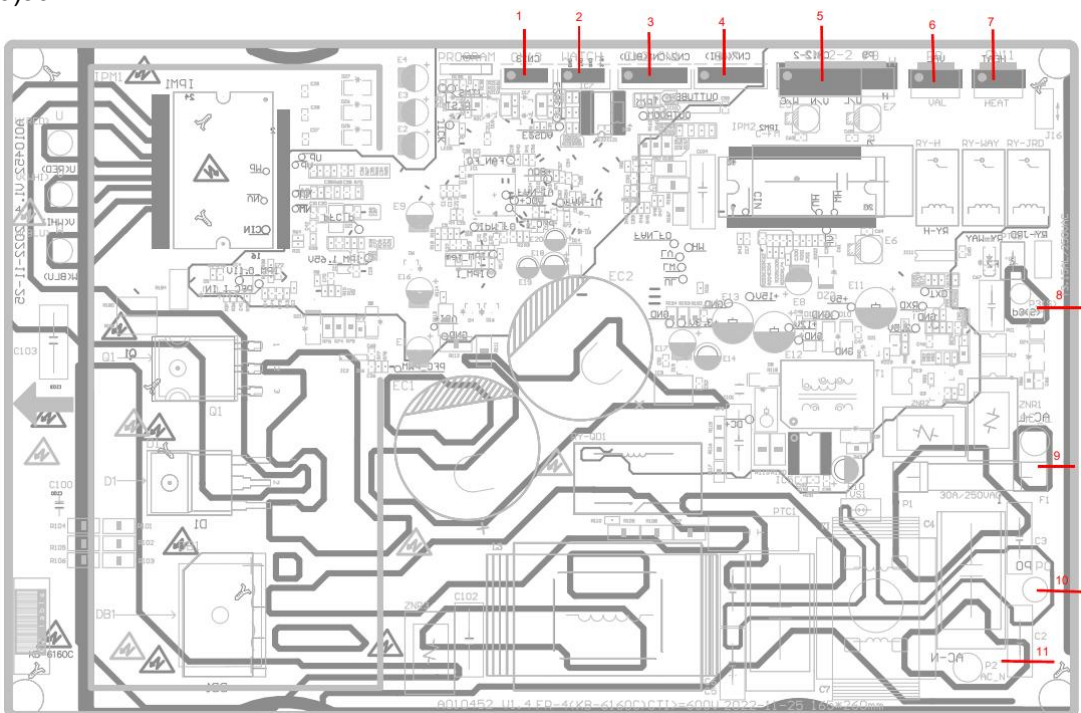

1	Reserved	7	Compressor crankcase electric heating belt
2	Reserved	8	Communication line
3	Outdoor temperature sensor	9	Live wire input
4	Electronic expansion valve	10	Ground wire
5	DC fan motor output	11	Neutral wire input
6	Four-way valve		

TCHB136(148,160)J0T

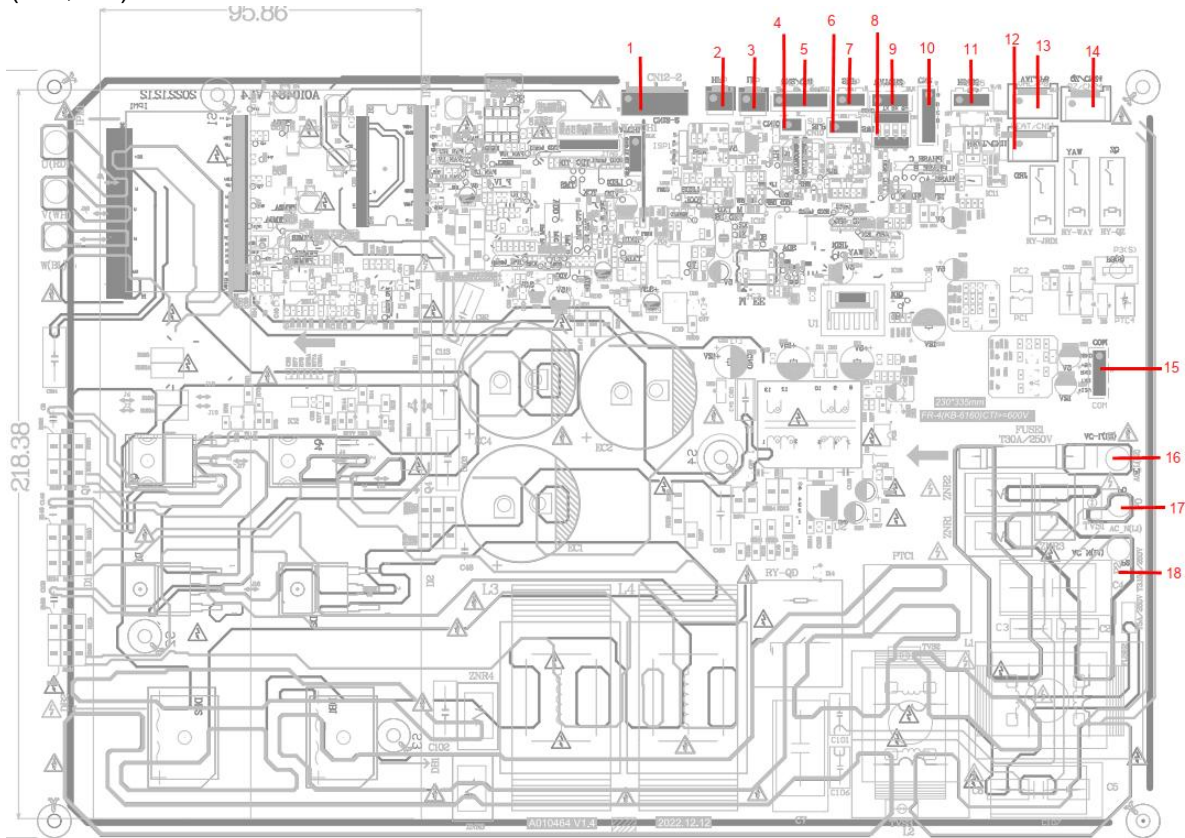

1	DC fan motor output	10	Electronic expansion valve
2	High-voltage switch	11	485 communication
3	Low-voltage switch	12	Compressor crankcase electric heating belt
4	Reserved	13	Four-way valve
5	Outdoor temperature sensor	14	Reserved
6	Reserved	15	Reserved
7	High pressure sensor	16	Live wire input
8	Reserved	17	Ground wire
9	Reserved	18	Neutral wire input

## 3.9 Built-in Draining Pump

### 3.9.1 Duct Type (Optional)

- Built-in draining pump to make sure condensed water drain out reliably. Built-in drain pump can lift the water to 1200mm upmost, which widens the drainage piping range.

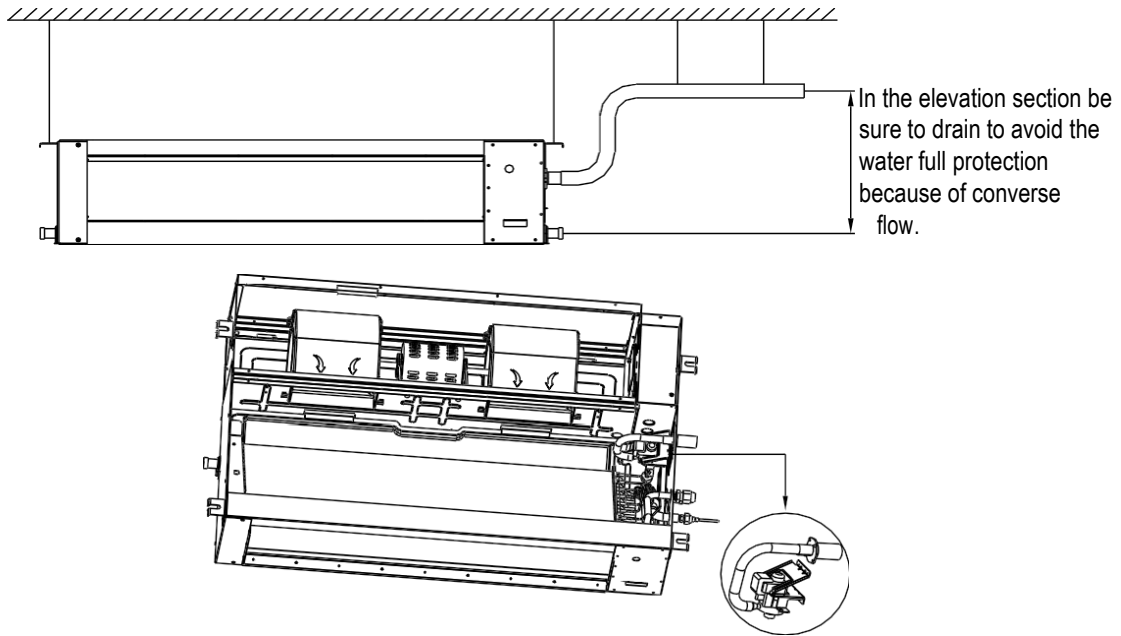

## 4. Electronic Controller Introduction

### 4.1 Remote Controller

Remote control DISPLAY

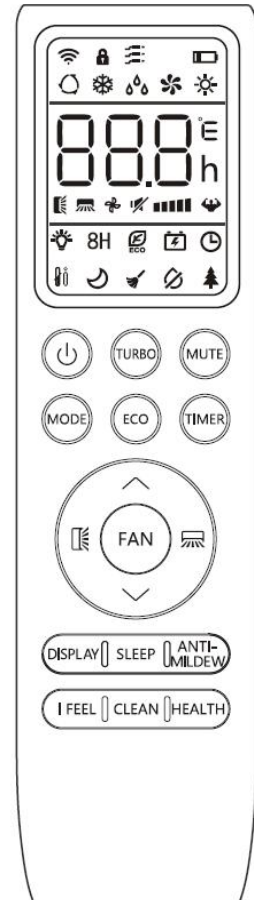

Meaning of symbols on the liquid crystal display.

No.	Symbols	Meaning
1		Battery indicator
2		Auto Mode
3		Cooling Mode
4		Dry Mode
5		Fan only Mode
6		Heating Mode
7		ECO Mode
8		Timer
9		Temperature indicator
10		Fan speed: Auto/ low/ low- mid/ mid/ mid- high/ high
11		Mute function
12		TURBO function
13		Up-down auto swing
14		Left-right auto swing
15		SLEEP function
16		Health function
17		I FEEL function
18	8H	8oC heating function
19		Signal indicator
20		Gentle wind
21		Child-Lock
22		Display ON/OFF
23		GEN function
24		Self-Clean function
25		Anti-Mildew



The display and some functions of the remote controller may vary according to the model.



No.	Button	Function
1		To turn on/off the air conditioner.
2	^	To increase temperature, or Timer setting hours.
3	v	To decrease temperature, or Timer setting hours.
4	MODE	To select the mode of operation (AUTO, COOL, DRY, FAN, HEAT).
5	ECO	To activate/deactivate the ECO function.
		Long press to activate/deactivate the 8oC heating function (depending on models).
6	TURBO	To activate/deactivate the TURBO function.
7	FAN	To select the fan speed of auto/mute/low/low-mid/mid/mid-high/high/turbo.
8	TIMER	To set the time for timer on/off.
9	SLEEP	To switch-on/off the function SLEEP.
10	DISPLAY	To switch-on/off the LED display.
11		To stop or start horizontal louver movement or set the desired up/down air flow direction.
12		To stop or start horizontal louver movement or set the desired left/right air flow direction.
13	I FEEL	To switch-on/off the I FEEL function.
14	MUTE	To switch-on/off the MUTE function.
		Long press to activate/deactivate the GEN function (depending on models).
15	MODE + TIMER	To activate/deactivate the CHILD-LOCK function.
16	CLEAN	To activate/deactivate the SELF-CLEAN function (depending on models).
17	FAN + MUTE or GENTLE WIND	To activate/deactivate the GENTLE WIND function (depending on models) (The function is not available for this series of products).
18	HEALTH	To activate/deactivate the HEALTH function (depending on models).
19	ANTI-MILDEW	To activate/deactivate the ANTI-MILDEW function.

 The display and some functions of the remote control may vary according to the model.

 The shape and position of buttons and indicators may vary according to the model, but their function is the same.

 The unit confirms the correct reception of each button with the beep.

## 4.2 Wired Remote Controller

### 4.2.1 An Introduction to Wire Controller

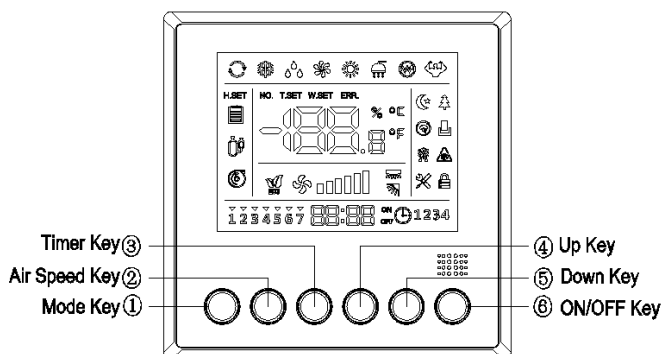

#### ◆ Description of Icons or Symbols

	Sleep		Fresh		Door Card		Defrost
	Anti-freeze		Set		Child Lock		Economic
	Up/Down Swing		Left/Right Swing		Degree centigrade		Fahrenheit
	Electric	<i>ERR.</i>	Error		Water Level		Water Pump Sign
<i>W.</i>	Current Water Temperature	<i>T.</i>	Ambient Temperature	<i>SET</i>	Set Temperature		Compressor
<i>ON</i>	Timer ON	<i>OFF</i>	Timer OFF				

Remark: If an icon goes on, it means “ON”; if such icon goes off, it means “OFF”.

#### ◆ Dial Setting

Definition	SW1-1	SW1-2	Description
Reserve	ON	-	/
	OFF	-	/
Reserve	-	ON	/
	-	OFF	/

### 4.2.2 Initial Power-on

It is necessary to initially power the wire controller on for self-check wherein all the icons or symbols go on for 3 seconds. During such period, all the key and remote controller operations are invalid.

### 4.2.3 Key Description

#### 4.2.3.1 [ON/OFF]

##### Key

#### 4.2.3.1.1

Press the [ON/OFF] key once to start the controller; press the [ON/OFF] key once again to stop the controller.

#### 4.2.3.1.2 Liquid Crystal Self-check:

Press the [ON/OFF] key to power the controller on for 5 seconds and then release such key; the controller enters self-check at the moment. The controller executes the liquid crystal self-check in the following sequence:

After the buzzer short sounds once, the following outputs successively motion (wherein the liquid crystal successively goes on from left to right and then go off.) After that, the controller exits from the self-check.

Notes:



1. The controller exits from the self-check status after it is powered off in the self-check status.
2. All the keys are invalid during the self-check.

#### 4.2.3.2 [Mode] Key

##### 4.2.3.2.1 Mode Switch

On the startup interface, press the [Mode] key once when the selected mode icon normally goes on and other icons go off. The switch sequence is as shown in the right picture.

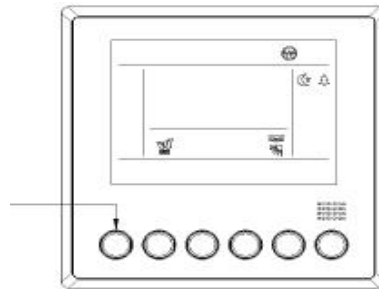

- The refrigeration machine is without the “Heat” icon.

● Automatic Mode: The controller with the power-down memory function can be powered on again after being powered down, re-judge the temperature and then re-execute the automatic mode; if the power-down memory function is not started, the controller will enter the standbymode.

##### 4.2.3.2 Function Setting:

On the startup interface, long press the [Mode] key for over 5 seconds to enter the function setting interface; short press the [Mode] key when the selected function icon twinkles with the frequency of 1Hz and other icons act as per the actual status (if the status is ON, the icons normally go on; otherwise, the icons go off.)

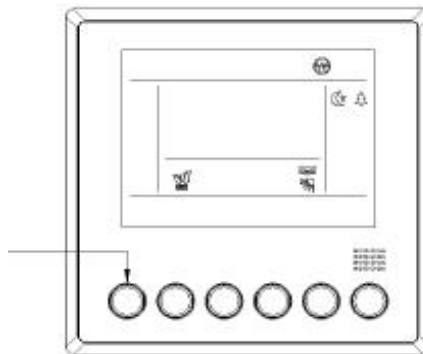

#### 4.2.3.3 [▲]/[▼] Key

4.2.3.3.1 On the startup interface, press the [▲]/[▼] key once to set the temperature increase or decrease by 1°C

/1°F;

Note: The operations of [▲] and [▼] keys of fresh air machine are invalid;

##### 4.2.3.3.2 Forced Defrosting

On the startup interface, set the wire controller to be in the heating mode and at the temperature of 16°C, and then finish the following 6 keys of operations within 5 seconds:

“[▲]→[▼]→[▲]→[▼]→[▲]→[▼]”. At the moment, the system successfully enters the forced defrosting and then the buzzer long beeps once.

#### 4.2.3.4 [Air Speed] Key

On the startup interface, press the [Air Speed] key once, the selected air speed icon normally goes on and other icons go off wherein the air speed switches in the cyclic sequence of low air speed → intermediate air speed → high air speed

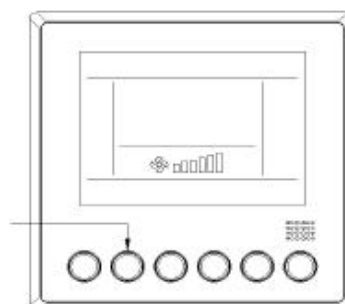

- When the wire controller is initially powered on, its default air speed is low and the icon of low

air speed is displayed.

● When the wire controller is at the time of automatic air, the air speed icon is successively displayed in the dynamic and cyclic sequence of low air speed → intermediate air speed → high air speed → low air speed.

● When the wire controller is at the time of automatic air, the air speed icon is successively displayed in the dynamic and cyclic sequence of low air speed → intermediate air speed → high air speed → idle → low air speed.

● If the air speed is of individual backup, the wire controller will display the last set air speed of the corresponding mode when it enters the same mode next time.

#### 4.2.3.5 [Timer] Key

4.2.3.5.1 Press the [Timer] key once to enter the timer setting interface (See Chapter 4.2.5---Timer Setting for details).

### 4.2.4 Auxiliary Functions=

#### 4.2.4.1 Child Lock

1. On the startup or shutdown interface, simultaneously press the [▲] and [▼] keys for over 5 seconds to enable the child lock when the child lock icon normally goes on.
2. When the child lock is valid, the operations of other keys are invalid but the icons twinkle with the frequency of 1Hz.

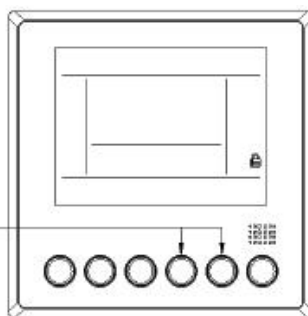

### 4.2.5 Installation

#### Duct Type、 Ceiling & Floor Type :

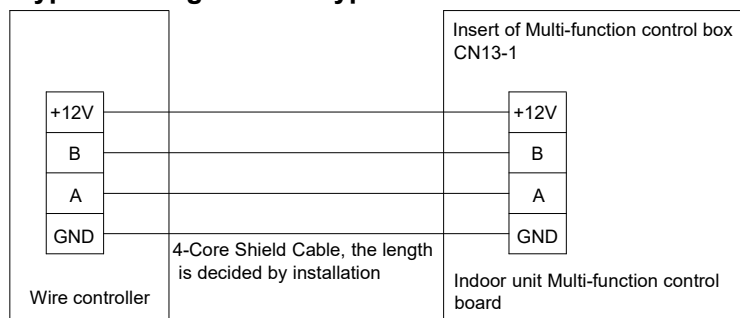

- ◆ Connect the stripping wire side of connective wires group with the terminal of the mainboard.
- ◆ Connect the other side of connective wires group with the female joint of wire controller.

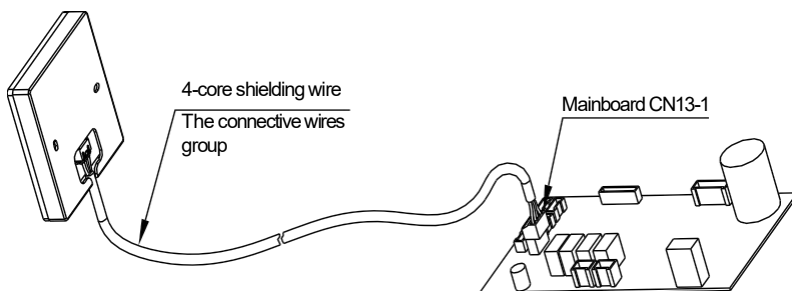

---

## **PART II Installation and Maintenance**

### **1. Notes for Installation and Maintenance**

#### **Safety Precautions**

##### **Important!**

Please read the safety of precautions carefully before installation and maintenance. The following contents are very important for installation and maintenance. Please follow the instructions below.

- The installation or maintenance must accord with the instructions.
- Comply with all national electrical codes and local electrical codes.
- Pay attention to the warnings and cautions in this manual.
- All installation and maintenance shall be performed by distributor or qualified person.
- All electric work must be performed by licensed technician according to local regulations and Instructions given in this manual.
- Be caution during installation and maintenance. Prohibit incorrect operation to prevent electric shock, casualty and other accidents.

#### **Warnings**

##### **Electrical Safety Precautions.**

- 1) Cut off the power supply of air conditioner before checking and maintenance.
- 2) The air conditioner must apply specialized circuit and prohibit share the same circuit with other appliances.
- 3) The air conditioner should be installed in suitable location and ensure the power plug is touchable.
- 4) Make sure each wiring terminal is connected firmly during installation and maintenance.
- 5) Have the unit adequately grounded. The grounding wire can't be used for other purposes.
- 6) Must apply protective accessories such as protective boards, cable-cross loop and wire clip.
- 7) The live wire, neutral wire and grounding wire of power supply must be corresponding to the live wire, neutral wire and grounding wire of the air conditioner.
- 8) The power cord and power connection wires can't be pressed by hard objects.
- 9) If power cord or connection wire is broken, it must be replaced by qualified person.
- 10) If the power cord or connection wire is not long enough, please get the specialized power cord or connection wire from the manufacture or distributor. Prohibit prolong the wire by yourself.
- 11) For the air conditioner without plug, an air switch must be installed in the circuit. The air switch Should be all-pole parting and the contact parting distance should be more then 3mm.
- 12) Make sure all wires and pipes are connected properly and the valves are opened before energizing.
- 13) Check if there is electric leakage on the unit body. If yes, please eliminate the electric leakage.
- 14) Replace the fuse with a new one of the same specification if it is burnt down, don't replace it with a cooper wire or conducting wire.
- 15) If the unit is to be installed in a humid place, the circuit breaker must be installed.

##### **Installation Safety Precaution**

- 1) Select the installation location according to the requirement of this manual. (See the requirements in installation part).
- 2) Handle unit transportation with care, the unit should not be carried by only one person if it is more than 20kg.
- 3) When installing the indoor unit and outdoor unit, a sufficient fixing bolt must be installed, make

---

sure The installation supporter is firm.

- 4) Wear safety belt if the height of working is above 2m.
- 5) Use equipped components or appointed components during installation.
- 6) Make sure no foreign objects are left in the unit after finishing installation.

**Improper installation may lead to fire hazard, explosion, electric shock or injury.**

**Safety precautions for Installing and Relocating the unit.  
To ensure safety, please be mindful of the following precautions.**

## **Warnings**

**1)** When installing or relocating the unit, be sure to keep the refrigerant circuit free from air or substances other than the specified refrigerant.

Any presence of air or other foreign substance in the refrigerant circuit will cause system pressure rise or compressor rupture, resulting in injury.

**2)** When installing or moving this unit, do not charge the refrigerant which is not comply with that on the nameplate or unqualified refrigerant.

Otherwise, it may cause abnormal operation, wrong action, mechanical malfunction or even serious safety accident.

**3)** When refrigerant needs to be recovered during relocating or repairing the unit, be sure that the unit is running in cooling mode. Then, fully close the valve at high pressure side (two-way valve). About 30-40 seconds later, fully close the valve at low pressure side (3-way valve), immediately stop the unit and disconnect power. Please note that the time for refrigerant recovery should not exceed 1 minute.

If refrigerant recovery takes too much time, may be cause compressor overheat, resulting in injury.

**4)** During refrigerant recovery, make sure that two-way valve and 3-way valve are fully closed and power is disconnected before detaching the connecting pipe.

If compressor starts running when the valves is open and connecting pipe is not yet connected, air will be sucked in and cause pressure rise and then compressor overheat or gas leak, resulting in injury.

**5)** When installing the unit, make sure that connecting pipe is securely connected before the compressor starts running.

If compressor starts running when the valves is open and connecting pipe is not yet connected, air will be sucked in and cause pressure rise and then compressor overheat or gas leak, resulting in injury.

**6)** Prohibit installing the unit at the place where there may be leaked corrosive gas or flammable gas.

If there leaked gas around the unit, it may cause explosion and other accidents.

**7)** Do not use extension cords for electrical connections. If the electric wire is not long enough, please contact a local service center authorized and ask for a proper electric wire. Poor connection may lead to electric shock or fire.

**8)** Use the specified types of wires for electrical connections between the indoor and outdoor units. Firmly clamp the wires so that their terminals receive no external stresses.

**Electric wires with insufficient capacity, wrong wire connections and insecure wire terminals may cause electric shock or fire.**

---

# Refrigerant Notice/Concentration

This air conditioner uses R32 refrigerant. The construction area for installation, operation and storage

of the air conditioner must be larger than the minimum construction area. The minimum area for installation is determined by:

1.Refrigerant charging quantity for the entire system (ex-factory charging quantity + additional charging quantity);

2.Checking out in the applicable tables:

- (1) For indoor unit, confirm the model of indoor unit and check the corresponding table.
- (2) For outdoor unit that is installed or placed indoors, select the corresponding table according to the height of the room.

Height of the room	Select the applicable table
< 1.8m	Floor standing type
≥1.8m	Wall mounted type
≥2.2m	Ceiling type

3.Refer to the following table to check out the minimum construction area.

Ceiling type		Wall mounted type		Floor standing type	
Weight (kg)	Area (m <sup>2</sup> )	Weight (kg)	Area (m <sup>2</sup> )	Weight (kg)	Area (m <sup>2</sup> )
< 1.224	—	< 1.224	—	< 1.224	—
1.224	0.956	1.224	1.43	1.224	12.9
1.4	1.25	1.4	1.87	1.4	16.8
1.6	1.63	1.6	2.44	1.6	22.0
1.8	2.07	1.8	3.09	1.8	27.8
2.0	2.55	2.0	3.81	2.0	34.3
2.2	3.09	2.2	4.61	2.2	41.5
2.4	3.68	2.4	5.49	2.4	49.4
2.6	4.31	2.6	6.44	2.6	58.0
2.8	5.00	2.8	7.47	2.8	67.3
3.0	5.74	3.0	8.58	3.0	77.2
3.2	6.54	3.2	9.76	3.2	87.9
3.4	7.38	3.4	11.0	3.4	99.2
3.6	8.27	3.6	12.4	3.6	111
3.8	9.22	3.8	13.8	3.8	124
4.0	10.2	4.0	15.3	4.0	137
4.2	11.3	4.2	16.8	4.2	151
4.4	12.4	4.4	18.5	4.4	166
4.6	13.5	4.6	20.2	4.6	182
4.8	14.7	4.8	22.0	4.8	198
5.0	16.0	5.0	23.8	5.0	215
5.2	17.3	5.2	25.8	5.2	232
5.4	18.6	5.4	27.8	5.4	250
5.6	20.0	5.6	29.9	5.6	269
5.8	21.5	5.8	32.1	5.8	289
6.0	23.0	6.0	34.3	6.0	309
6.2	24.5	6.2	36.6	6.2	330
6.4	26.1	6.4	39.1	6.4	351
6.6	27.8	6.6	41.5	6.6	374
6.8	29.5	6.8	44.1	6.8	397
7.0	31.3	7.0	46.7	7.0	420
7.2	33.1	7.2	49.4	7.2	445
7.4	34.9	7.4	52.2	7.4	470
7.6	36.9	7.6	55.1	7.6	496
7.8	38.8	7.8	58.0	7.8	522
8.0	40.8	8.0	61.0	8.0	549

## Cautions:

- Please contact the nearest after-sale service center when maintenance is necessary. At the time of maintenance, the maintenance personnel must strictly comply with the Operation Manual provided by the corresponding manufacturer and any non-professional is prohibited to maintain the air conditioner.

- It is necessary to comply with the provisions of gas-related national laws and regulations.
- It is necessary to clear away the refrigerant in the system when maintaining or scrapping an air conditioner.

- When filling the combustible refrigerant, any of your rude operations may cause serious injury or injuries to human body or bodies and object or objects.

- A leak test must be done after the installation is completed.
- It is a must to do the safety inspection before maintaining or repairing an air conditioner using combustible refrigerant in order to ensure that the fire risk is reduced to minimum.

## 1 ) Installation Safety

### Installation Safety Principles

#### Site Safety



Open Flames Prohibited



Ventilation Necessary



#### Operation Safety



Mind Static Electricity



Must wear protective clothing and anti-static gloves



Don't use mobile phone

#### Installation Safety

- Refrigerant Leak Detector
- Appropriate Installation Location



The left picture is the schematic diagram of a refrigerant leak detector.

#### Caution:

- The installation should be in a well-ventilated condition location.
- When you installing or maintaining an air conditioner using Refrigerant R32, the location should be free fire from open or any other goods temperature higher than 548°C for R32 which easily produces open fire include welding, smoking, drying oven.
- When installing an air conditioner of R32, it is necessary to take appropriate anti-static measures such as wear anti-static clothing and gloves.
- It is necessary to choose the location for installation or maintenance where in the air inlets and outlets of the indoor and outdoor units should be not surrounded by obstacles or close to any heat source or combustible and/or explosive environment.
- If the indoor unit suffers refrigerant leak during the installation, it is necessary to immediately turn off the valve of the outdoor unit and all the personnel should go out till the refrigerant leaks completely for 15 minutes. If the product is damaged, it is a must to carry such damaged product back to the maintenance station and it is prohibited to weld the refrigerant pipe or conduct other operations on the user's site.
- It is necessary to choose the place where the inlet and outlet air of the indoor unit is even.
- It is necessary to avoid the places where there are other electrical products, power switch plugs

and sockets, kitchen cabinet, bed, sofa and other valuables right under the lines on two sides of the indoor unit.

### Special tools:

Tool Name	Requirement(s) for User
Mini Vacuum Pump	It should be an explosion-proof vacuum pump; can ensure certain precision and its vacuum degree should be lower than 10Pa.
Filling Device	It should be a special explosion-proof filling device; have certain precision and its filling deviation should be less than 5g.
Leak Detector	It should be calibrated regularly; and its annual leak rate should not exceed 10g.
Concentration Detector	A) The maintenance site should be equipped with a fixed-type combustible refrigerant concentration detector and connected to a safeguard alarm system; its error must be not more than 5%. B) The installation site should be equipped with a portable combustible refrigerant concentration detector which can realize two-level audible and visual alarm; its error must be not more than 10%. C) The concentration detectors should be calibrated regularly. D) It is necessary to check and confirm the functions before using the concentration detectors.
Pressure Gauge	A) The pressure gauges should be calibrated regularly. B) The pressure gauge used for Refrigerant 22 can be used for Refrigerants R290 and R161; the pressure gauge used for R410A can be used for Refrigerant 32.
Fire Extinguisher	It is necessary to carry fire extinguisher(s) when installing and maintaining an air conditioner. On the maintenance site, there should be two or more kinds of dry powder, carbon dioxide and foam fire extinguishers and that such fire extinguishers should be placed at stipulated positions, with eye-catching labels and in handy places.

## Maintenance

### 1). Inspections before maintenance.

#### (1) Inspection of maintenance environment

- There should be no leaked refrigerant in the room before operation.
- It is only allowed to operate in a room which meets the area requirement on the nameplate.
- It is necessary to make the room keep a continuous ventilation state at the time of maintenance.
- The room in the maintenance should be free from fire or welding, smoking, drying oven or any other goods temperature higher than 548°C (R32) which easily produces fire.
- During the maintenance, it is necessary to ensure that any person's any mobile phone or any electronic product with radiation in the room is powered off.
- The maintenance area should be equipped with a drying powder or carbon dioxide fire extinguisher and that such fire extinguisher can work.

#### (2) Inspection of maintenance equipment

- Check the maintenance equipment is applicable to the refrigerant or not and it is only allowed to use the professional equipment recommended by the air conditioner manufacturer.
- Check the refrigerant leak detector whether has been calibrated. The set maximum alarm concentration of the refrigerant leak detector should not exceed 25% of the lower explosion limit



---

(LEL), the refrigerant leak detector must be working during maintenance.

## **2). Inspection of air conditioner**

- It is necessary to ensure that the air conditioner is in reliable ground connection before maintenance.

- Make sure powered supply to air conditioner is off. Before maintenance, it is necessary to cut off the power and discharge the capacitor power which used in the air conditioner. If it is a must to need the power supply during the maintenance, it is necessary to do ongoing leak detection at the most dangerous position/point in order to avoid potential danger.

- Check the warning labels on the air conditioner whether are in good condition. It is necessary to replace the damaged or smeared warning labels.

## **3). Leak inspection before maintenance**

Before maintenance, use the leak detector or concentration detector (pump-type) recommended by the corresponding air conditioner manufacturer to check the air conditioner leak or not.

### **Warning**

If leak may exist, it is necessary to move all the fire out from the site or extinguish fire and then immediately shut off the air conditioner. Meanwhile, it is necessary to make sure well-ventilated.

## **4). Safety principles during the maintenance**

- At the time of maintenance, it is necessary to ensure well-ventilation on the site.
- It is prohibited to use fire including welding, smoking or other purposes. It is prohibited to use mobile phones.

- At the time of maintenance, if the relative humidity is lower than 40%, it is necessary to wear anti-static clothing and gloves.

- If the combustible refrigerant is found leaking during the maintenance, it is a must to immediately take forced ventilation and plug up the leak source.

- If the product is damaged to the extent that it is a must to open the refrigerating system for maintenance, it is a must to carry the product back to the maintenance station for maintenance. (It is prohibited to weld the refrigerant pipe and do other operations on the user's site.)

- It is necessary to return the air conditioner to its initial state if it is necessary to provide visiting service again due to lacking spare part during the maintenance. Moreover, it is a must to ensure that the refrigerating system is in secure ground connection.

- If it is necessary to provide visiting service with a refrigerant cylinder, the volume of refrigerant filled in such refrigerant cylinder should not exceed the stipulated value. When such cylinder is stored in a vehicle or placed on the installation or maintenance site, it is necessary to place it vertically and securely and keep it away from any place where there is any heat source, combustion source, radiation source or electrical equipment.

## **5). Requirements for the site of maintenance-station**

- The maintenance location should be well-ventilated, with leveled ground and not in a basement.

- The maintenance should be divided into welding and non-welding areas both of which should be labeled clearly. There should be a certain safety distance between the two areas. The maintenance location should be equipped with ventilating and air-exhausting equipment to prevent the refrigerant gas from aggregating.

---

- It is necessary to provide some relevant instruments such as combustible refrigerant leak detector and have a leak detecting instrument management system. It is necessary to confirm that the leak detector can work normally before maintenance.

- The main power switch should be set outside the maintenance location and equipped with protective (explosion-proof) devices.

- It is necessary to provide firefighting devices such as dry powder or carbon dioxide fire extinguisher appropriate for extinguishing the electrical fire and keep such firefighting devices in a usable condition.

- Temporary wires and sockets are prohibited on the maintenance location.

#### **6). Requirements for fill the refrigerants**

- It is necessary to use nitrogen to clear the cyclic system before operating the refrigerating system and vacuumize the outdoor unit for 30 minutes at least.

- It is necessary to ensure that there is no cross contamination among different refrigerants when the refrigerant filling device is used. The total length including the refrigerant pipeline should be as short as possible in order to reduce the residual refrigerant inside such pipeline.

- It is necessary to vertically place the refrigerant storage tanks.

- It is necessary to ensure that the refrigerating system is in ground connection before the refrigerant is filled.

- When filling the refrigerant, it is necessary to fill corresponding type and volume of refrigerant as per the requirements on the product nameplate and overfilling is prohibited.

- It is necessary to seal the system in a safe sealing way after maintaining the refrigerating system.

- It is necessary to ensure that the maintenance will not damage or reduce the safety protection grade of the original system.

#### **7). In-maintenance welding**

- It is necessary to ensure that the maintenance location is well-ventilated.

- Before welding the outdoor unit, it is a must to confirm that the refrigerating system has been drained and the system has been cleaned and ensure that there has been no refrigerant in the outdoor unit.

- It is necessary to close the stop valve of the outdoor unit when using a welding gun to do the maintenance work such as cutting and welding.

#### **8). Maintenance of electrical components**

- It is necessary to use a special leak detector to check whether the maintained electrical parts location have the leak refrigerant.

- It is not allowed to refit, remove or cancel any component with the safety protection function after finishing the maintenance process.

- When maintaining the sealed parts, it is necessary to turn off the power of air conditioner before opening the sealing cover. When power supply is needed, it is necessary to do the ongoing leak detection at the most dangerous position in order to prevent potential danger.

- It is necessary to specially note that the maintenance of electrical components will not affect the replacement of protective cover.

---

- In order to ensure that the sealing function is not damaged after maintenance or the sealing material will not lose the effect of preventing the combustible gas leak due to ageing. So the substitute components should meet the requirements recommended by the air conditioner manufacturer.

## **Warning**

Before doing the trial operation after finishing the maintenance, it is a must to use a practical leak detector to inspect the leakage and reliability of ground connection in order to ensure that no refrigerant leakage and reliable ground connection.

The refrigerant storage tanks should be separately placed in a well-ventilated place at the temperature ranging from -10°C to 50°C and label them with warning labels.

### **9). Emergency Accident Handling**

A maintenance station should establish emergency handling plans. It is necessary to take appropriate precautionary measures in work. For example, it is prohibited to enter the location with any kindling material and it is prohibited to wear clothing or shoes which easily produce static.

Handling suggestions when a large amount of combustible refrigerant leaks:

- It is necessary to immediately operate the ventilating equipment while cutting off other power supply and evacuating the affected personnel urgently from the location.

- It is necessary to inform near residents of evacuating for over 20 meters from the location, make an alarm call, set the emergency area and prohibit irrelevant personnel and vehicles from approaching.

- The professional firefighters should wear anti-static clothing to handle the emergency on the site and cut off the source of leak.

- It is necessary to use nitrogen for blowing the site, especially the low-lying positions, clear away the residual combustible refrigerant gas from any area nearby and surrounding the leak point and use a handheld detector for detection and not clear the alarm until the concentration of refrigerant is zero.

## 2 Installation

### 2.1 Location Selection

#### 2.1.1 Indoor Unit Location Selection

- The place shall easily support the indoor unit's weight.
- The place can ensure the indoor unit installation and inspection.
- The place can ensure the indoor unit horizontally installed.
- The place shall allow easy waterdrainage.
- The place shall easily connect with the outdoor unit.
- The place where air circulation in the room should be good.
- There should not be any heat source or steam near the unit.
- There should not be any oil gas near the unit
- There should not be any corrosive gas near the unit
- There should not be any salty air near the unit
- There should not be strong electromagnetic wave near the unit
- There should not be inflammable materials or gas near the unit
- There should not be strong voltage vibration.

#### 2.1.2 Outdoor Unit Location Selection

- The place shall easily support the outdoor unit's weight.
- Locate the outdoor unit as close to indoor unit as possible
- The piping length and height drop can not exceed the allowable value.
- The place where the noise, vibration and outlet air do not disturb the neighbors.
- There is enough room for installation and maintenance.
- The air outlet and the air inlet are not impeded, and not face the strong wind.
- It is easy to install the connecting pipes and cables.
- There is no danger of fire due to leakage of inflammable gas.
- It should be a dry and well ventilation place
- The support should be flat and horizontal
- Do not install the outdoor unit in a dirty or severely polluted place, so as to avoid blockage of the heat exchanger in the outdoor unit.
- If it is built over the unit to prevent direct sunlight, rain exposure, direct strong wind, snow and other scraps accumulation, make sure that heat radiation from the condenser is not restricted.

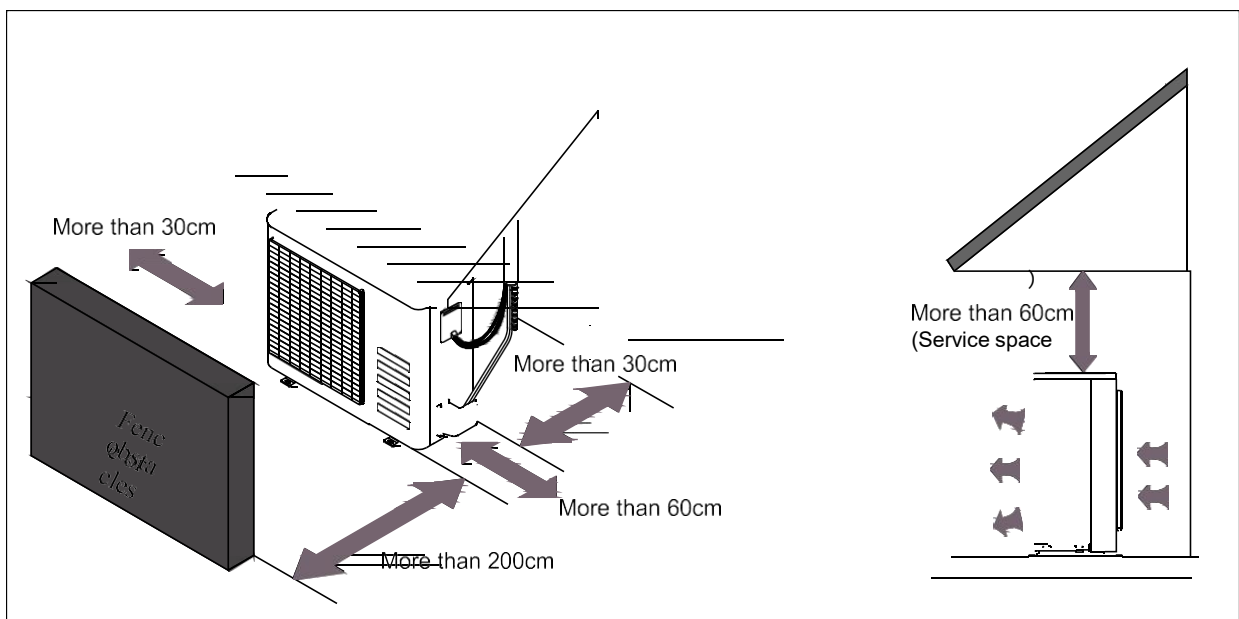

### 2.2 Indoor Unit Installation

## 2.2.2 Installation of Duct Type

### 2.2.2.1 Service Space for Indoor Unit

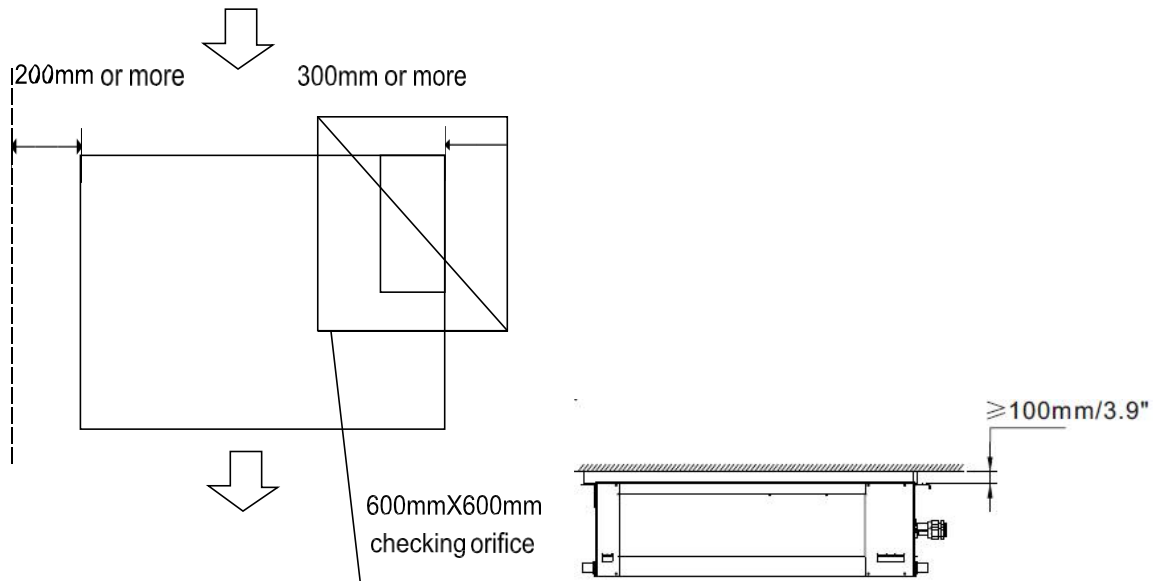

**Note:** Install the indoor unit at a height of more than 2.5m (8') above the floor.

### 2.2.2.2 Hang Indoor Unit

1. Please refer to the part of 3.4.2 to locate the four positioning screw bolt hole on the ceiling. Be sure to mark the areas where ceiling hook holes will be drilled.
2. Install and fit pipes and wires after you have finished installing the main body. When choosing where to start, determine the direction of the pipes to be drawn out. Especially in cases where there is a ceiling involved, align the refrigerant pipes, drain pipes, and indoor and outdoor lines with their connection points before mounting the unit.
3. Install hanging screw bolts
  - Cut off the roof beam.
  - Strengthen the place that has been cut off, and consolidate the roof beam.
4. After you select an installation location, align the refrigerant pipes, drain pipes, as well as indoor and outdoor wires with their connection points before mounting the unit.
5. Drill 4 holes 10cm (4") deep at the ceiling hook positions in the internal ceiling. Be sure to hold the drill at a 90° angle to the ceiling.
6. Secure the bolt using the washers and nuts provided.
7. Install the four suspension bolts.
8. Mount the indoor unit with at least two people to lift and secure it. Insert suspension bolts into the unit's hanging holes. Fasten them using the washers and nuts provided.

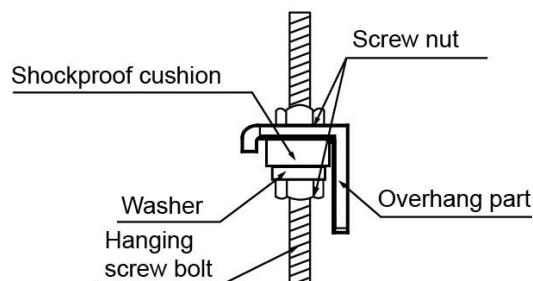

**Note:** Hang the nut inside the U slot of the installation panel. To confirm level degree with gradienter . Leaning downside toward non-draining side is prohibited. (see below)

**Note:** Confirm the minimum drain tilt is 1/100 or more.

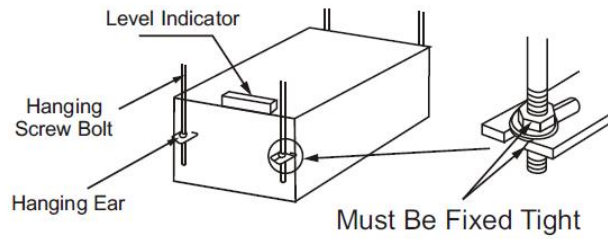

### 2.2.2.3 Choice of Air Return Ways

This indoor unit is fitted with downward air return, which can be changed to its backward counterpart if necessary. Please follow the steps below to change it into the mode of air return backward.

Air return downward

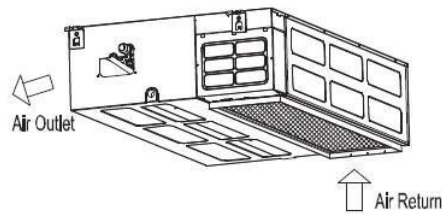

Loose the nut and dismantle flannel plate and filter; Loose the nut dismantle the back over

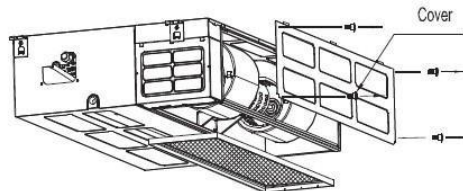

Install the flannel plate and filter at the backside; Install the cover to the downside.

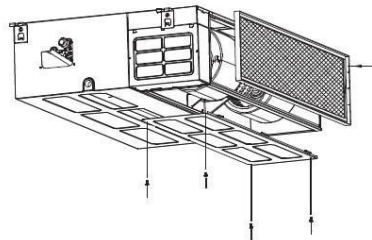

Air return backward

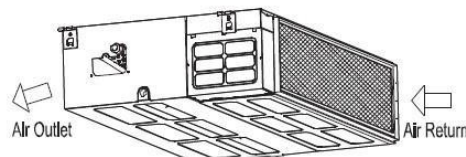

### 2.2.2.4 Duct Installation

#### 2.2.2.4.1 Outlet Air Pipe Installation

● Generally, we have two types of outlet pipe available, i.e. rectangular or round ones.

## 2.2.2.4 Duct Installation

### 2.2.2.4.1 Outlet Air Pipe Installation

- Generally, we have two types of outlet pipe available, i.e. rectangular or round ones.
- Rectangular air conduit can be directly connected to air outlet of indoor unit by rivets. For outlet Dimensions, see outline drawing of the unit.

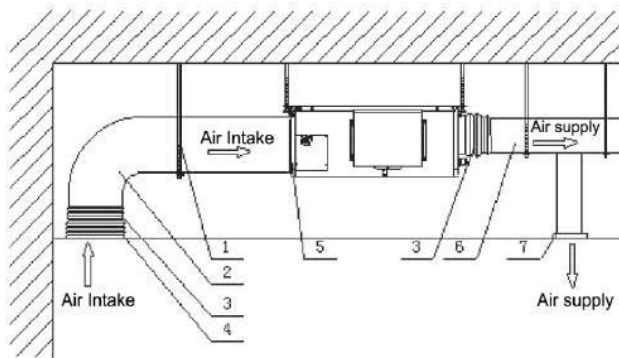

No.	Name	No.	Name
1	Hanger	5	Filter
2	Air Intake Pipe	6	Main Air Supply Pipe
3	Canvas Air Pipe	7	Air Supply Outlet
4	Air Intake		

- Round air conduit should be connected to a piece of transitional air conduit before it is connected to air outlet of indoor unit, the other end of it can be separately connected to air conduit window or connected to air conduit window after air flow diversion, and the total length should not be over 6m. As shown in figure below, air speeds at all air outlets should be set to basically consistent so as to meet the room air-conditioning requirements.

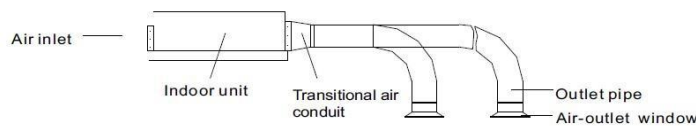

### 2.2.2.4.2 Return Air Pipe Installation

- In case sidewise air intake is adopted, return air pipe should be fabricated and rivet-connected to return air orifice, and the other end of it should be connected to return air window.
- In case of underside air intake, purchase or fabricate a section of pleated canvas air conduit serving as transition joint for return air orifice and return air window. in this way, it can be freely adjusted according to height of indoor ceiling board; in addition, during operation of the unit, canvas air conduit may avoid vibration of ceiling board, as shown in figure below.

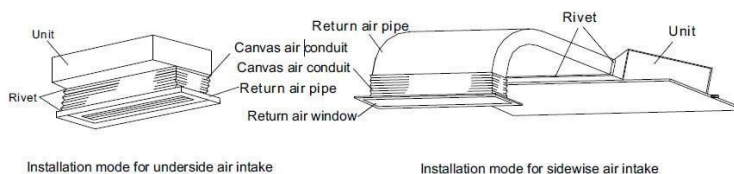

### 2.2.2.4.2 Tips for Installation of Return Air Pipe and Outlet Pipe

To minimize energy loss occurring in transmission process and condensed water during heating operation, return air pipe and outlet pipe should be equipped with heat-insulating layer as shown in figure below.

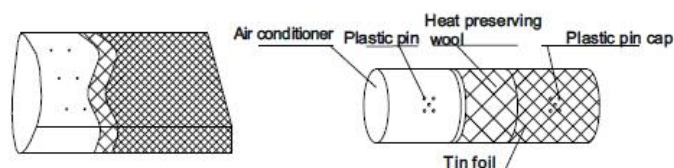

**NOTE:** Ensure sufficient space for installation and repair. (see the picture for details)

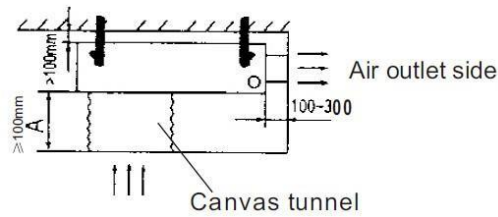

- Return air pipe and outlet pipe should be fixed to floor precast slabs by iron stand; in addition, all ports of the air conduit should be tightly sealed by gasket cement, and it is advisable that the edge clearance of return air pipe should be 150mm at least.
- Drain pipe for condensed water should be installed with minimum gradient of 1 , and the drain pipe should be insulated with heat-preserving pipe casing as well.

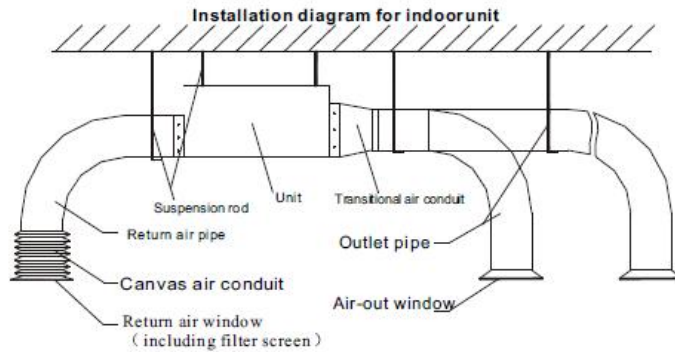
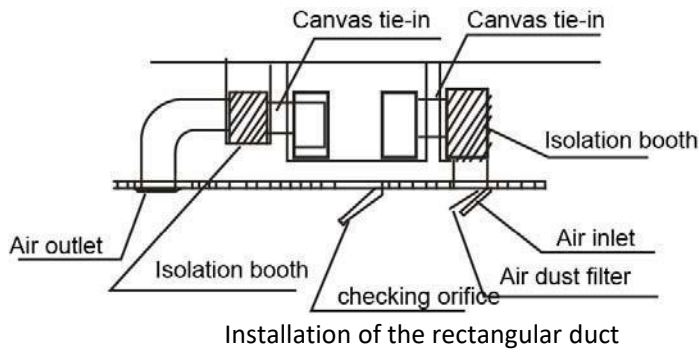

Installation of the round duct

## 2.3 Outdoor Unit Installation

### 2.3.1 Service Space for Outdoor Unit

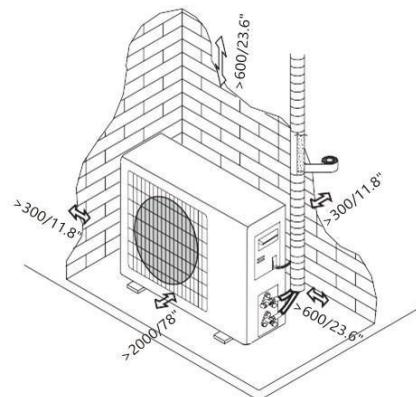

Unit: mm

**NOTE:** The minimum distance between the outdoor unit and walls described in the installation guide does not apply to airtight rooms. Be sure to keep the unit unobstructed in at least two of the



three directions (Front, Left, Right). (As shown on the right)

### 2.3.2 Install the Unit

Bolt pitch refers to the part of 3.4.3

Since the gravity center of the unit is not at its physical center, so please be careful when lifting it with a sling.

Never hold the inlet of the outdoor unit to prevent it from deforming.

Do not touch the fan with hands or other objects.

Do not lean it more than 45° , and do not lay it sidelong.

Make concrete foundation according to the specifications of the outdoor units.

Fasten the feet of this unit with bolts firmly to prevent it from collapsing in case of earthquake or strong wind.

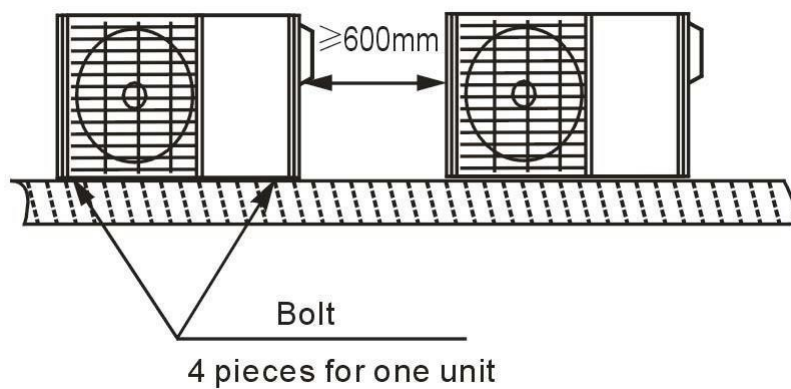

### 2.3.3 Outdoor Unit Condensed Water Drainage (Optional)

The condensed water and the ice formed in the outdoor unit during heating operation can be drained away through the drain pipe

1. Fasten the drain port in the 25mm hole placed in the part of the unit as shown in the picture.
2. Connect the drain port and the drain pipe. Pay attention that water is drained in a suitable place.

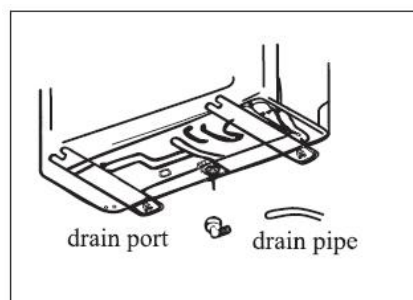

## 2.4 Drainage Pipe Installation

Install the drainage pipe as shown below and take measures against condensation. Improperly installation could lead to leakage and eventually wet furniture and belongings.

### 2.4.1 Installation Principle

- Ensure at least 1/100 slope of the drainage pipe
- Adopt suitable pipe diameter
- Adopt nearby condensate water discharge

---

## 2.5 Vacuum Drying and Leakage Detection

### 25.1 Safety Precautions

- Use a vacuum pump with a gauge reading lower than -0.1 MPa and an air discharge capacity above 40L/min.
- The outdoor unit does not need vacuuming. DO NOT open the outdoor unit's gas and liquid stop valves.
- Ensure that the Compound Meter reads -0.1 MPa or below after 2 hours. If after three hours of operation and the gauge reading is still above -0.1 MPa, check if there is a gas leak or water inside

the pipe. If there is no leakage, perform another evacuation for 1 or 2 hours.

- DO NOT use refrigerant gas to evacuate the system.

### 2.5.2 Evacuation Instructions

**NOTE:** Before using manifold pressure gauge and vacuum pump, please read their operating instructions and be familiar with how to use the manual correctly

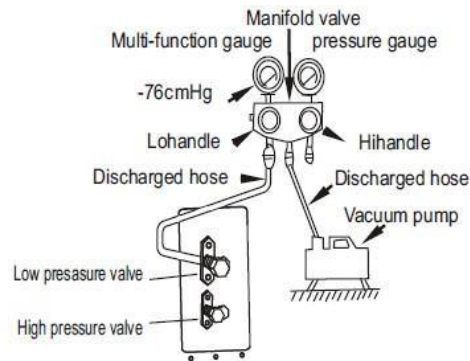

1. Connect the hose of manifold pressure gauge to the maintenance port on the low pressure valve of outdoor unit.
2. Connect another hose from manifold pressure gauge to vacuum pump.
3. Open the Low Pressure side of the manifold gauge. Keep the High Pressure side closed.
4. Turn on the vacuum pump to empty the gas in the system.
5. Run the vacuum pump for at least 15 minutes, or until the compound meter reads - 76cmhg (- 1 X10<sup>5</sup>pa).
6. Close the low pressure side of the manifold pressure gauge and close the vacuum pump.
7. Wait for 5 minutes and check whether the system pressure changes.

**NOTE:** If there is no change in system pressure, unscrew the cap from the high pressure valve. If there is a change in system pressure, there may be a gas leak.

8. Insert a hex wrench into the high-pressure valve and open the valve by turning the wrench in a 1/4 counter clockwise turn. Listen for any gas coming out of the system and close the valve after 5 seconds.

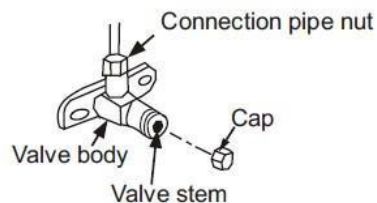

9. Observe the pressure gauge for one minute to make sure that the pressure does not change. The pressure gauge should read slightly above atmospheric pressure

10. Remove the charge hose from the service port.
11. Using hexagonal wrench, fully open both the high pressure and low pressure valves.
12. Tighten valve caps by hand, then tighten it using the proper tool.

**NOTE:** When opening valve stems, turn the hexagonal wrench until it hits against the stopper. DO NOT try to force the valve to open further.

### 2.5.3 Leakage Detection

- 1). With leakage detection.

Check if there is leakage with leakage detection.

2). With soap water. If leakage detection is not available, please use soap water for leakage detection. Apply soap water at the suspected position and keep the soap water for more than 3min. If there are air bubbles coming out of this position, there is a leakage.

---

## 2.6 Additional Refrigerant Charge

### Note:

- Refrigerant charging must be done after wiring, vacuuming and leak testing.
- Use electronic scale or fluid infusion apparatus to weight refrigerant to be recharged. Be sure to avoid extra refrigerant charged, it may cause liquid hammer of the compressor or protections.
- Charging with mismatched refrigerant can cause an explosion or an accident. Make sure that a suitable refrigerant is used.
- The refrigerant container must be opened slowly. Always use guards when charging the system.
- Do not mix refrigerant types. For R32 refrigerant models, when adding refrigerant to the air conditioner, ensure the safety of the conditions in the area by controlling flammable materials
- Always use gloves and glasses to protect your hands and eyes during the charge work.
- Use supplementing flexible pipe to connect refrigerant cylinder, pressure gauge and outdoor unit. And The refrigerant should be charged in liquid state. Before recharging, The air in the flexible pipe and manifold gauge should be exhausted.
- After finished refrigerant recharge process, check whether there is refrigerant leakage at the connection joint part.(Using gas leakage detector or soap water to detect).

Some systems require additional refrigerant charge depending on the length of the pipe. The standard pipe length of this air conditioner is 5 meters (16 feet). The following table can be used to calculate the additional refrigerant to be charged:

Liquid pipe diameter	6.35(1/4")	9.52(3/8")	12.7(1/2")
Additional charge for 1m/ft (R32)	12g/0.13oz	24g/0.26oz	40g/0.42oz

## 2.7 Engineering of Insulation

### 2.7.1 Insulation of Refrigerant Pipe

#### 2.7.1.1 Operational Procedure of Refrigerant Pipe Insulation

Cut the suitable pipe → insulation (except joint section) → flare the pipe → piping layout and connection → vacuum drying → insulate the joint parts

#### 2.7.1.2 Purpose of Refrigerant Pipe Insulation

- During operation, temperature of gas pipe and liquid pipe shall be over-heating or over-cooling extremely. Therefore, it is necessary to carry out insulation; otherwise it shall debase the performance of unit and burn compressor.
- Gas pipe temperature is very low during cooling. If insulation is not enough, it shall form dew and cause leakage.
- Temperature of gas pipe is very high (generally 50-100°C) during heating. Insulation work must be carried out to prevent hurt by carelessness touching.

#### 2.7.1.3 Insulation Material Selection for Refrigerant Pipe

- The burning performance should over 120°C
- According to the local law to choose insulation materials
- The thickness of insulation layer shall be above 10mm. If in hot or wet environment place, the layer of insulation should be thicker accordingly.

#### 2.7.1.4 Installation Highlights of Insulation Construction

- Gas pipe and liquid pipe shall be insulated separately, if the gas pipe and liquid pipe were insulated together; it will decrease the performance of air conditioner.

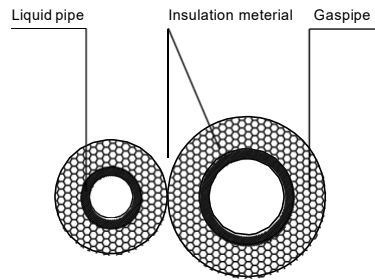

- The insulation material at the joint pipe shall be 5~10cm longer than the gap of the insulation material.
- The insulation material at the joint pipe shall be inserted into the gap of the insulation material.
- The insulation material at the joint pipe shall be banded to the gas pipe and liquid pipe tightly.
- The linking part should be use glue to paste together
- Be sure not bind the insulation material over-tight, it may extrude out the air in the material to cause bad insulation and cause easy aging of the material.

## 2.7.2 Insulation of Drainage Pipe

### 2.7.2.1 Operational Procedure of Refrigerant Pipe Insulation

Select the suitable pipe → insulation (except joint section) → piping layout and connection → drainage test → insulate the joint parts

### 2.7.2.2 Purpose of Drainage Pipe Insulation

The temperature of condensate drainage water is very low. If insulation is not enough, it shall form dew and cause leakage to damage the house decoration.

### 2.7.2.3 Insulation Material Selection for Drainage Pipe

- The insulation material should be flame retardant material, the flame retardancy of the material should be selected according to the local law.
- Thickness of insulation layer is usually above 10mm.
- Use specific glue to paste the seam of insulation material, and then bind with adhesive tape. The width of tape shall not be less than 5cm. Make sure it is firm and avoid dew.

### 2.7.2.4 Installation and Highlights of Insulation Construction

- The single pipe should be insulated before connecting to another pipe, the joint part should be insulated after the drainage test.
- There should be no insulation gap between the insulation material.

## 2.8 Engineering of Electrical Wiring

### 2.8.1 Safety Precaution

- Always disconnect the power supply before working on the unit.
- All electrical wiring must be done according to local and national regulations.
- The wiring must be carried out by a certified technician. Improper connection may cause electrical failure, personal injury and fire.
- This unit must use independent circuit and single outlet. Please DO NOT plug other equipment or chargers into the same outlet. If the circuit capacity is insufficient or the electrical system fails, it will cause electric shock, fire, unit and property loss.
- Connect the power cord to the terminal and secure it with the wiring clamp. Improper connections may cause fire.
- Make sure all wiring is correct and the control box cover is installed correctly. Otherwise, may cause overheating at the connection points, fire, and electrical shock.
- Ensure that main supply connection is made through a switch that disconnects all poles, with contact gap of a least 3mm (0.118").
- DO NOT modify the length of the power cord or use an extension cord.
- Connect the outdoor wires before connecting the indoor wires.
- Be sure to ground the equipment. The grounding wire shall be away from gas pipeline, water

pipe, lightning rod, telephone or other grounding wire. Improper grounding may cause electric shock.

- DO NOT connect the unit with the power source until all wiring and piping is completed.
- Please make sure not to cross the wire with the signal wire, which will cause distortion and interference.
- The unit must be connected to the main outlet. Normally, the power supply must have a low output impedance of 32 ohms.
- No other equipment should be connected to the same power circuit.

**NOTE:** The type of fuse for controller of indoor unit is 50CT/524 rated specification is T 5A,250VAC. Fuse for the whole unit is not supplied by the manufacturer, so the installer must employ a suitable fuse or other over-current protective device for the power supply circuit according to the maximum power input as required.

### 2.8.2 For Solid Core Wiring

- 1) Cut the wire end with a wire cutter or wire-cutting pliers, then strip the insulation about 25mm (1 inch).
- 2) Using a screwdriver, remove the terminal screw(s) on the terminal board.
- 3) Using pliers, bend the solid wire to form a loop suitable for the terminal screw.
- 4) Shape the loop wire properly, place it on the terminal board and tighten securely with the terminal screw using a screwdriver.

### 2.8.3 For Strand Wiring

- 1) Cut the wire end with a wire cutter or wire-cutting pliers, then strip the insulation about 10mm (3/8 inch).
- 2) Using a screwdriver, remove the terminal screw (s) on the terminal board.
- 3) Using a round terminal fastener or pliers, securely clamp a round terminal to each stripped wire end.
- 4) Position the round terminal wire, and replace and tighten the terminal screw with a screwdriver.

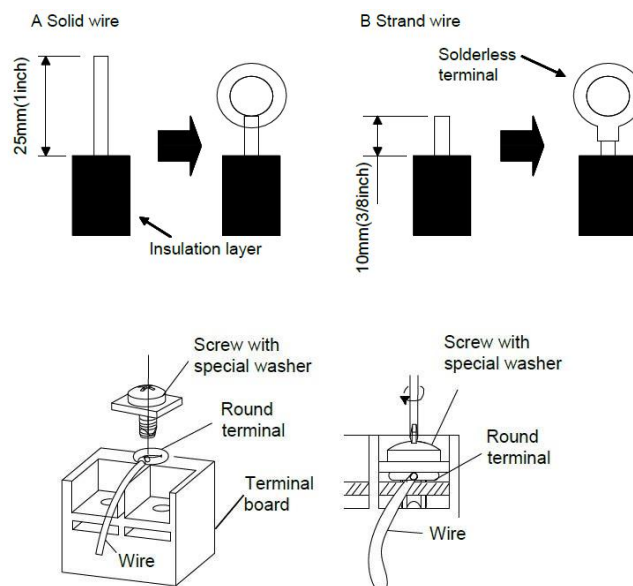

### 2.8.4 How to Fix Connection Cord and Power Cord by Cord Clamp

After passing the connection cord and power cord through the insulation tube, fasten it with the cord clamp

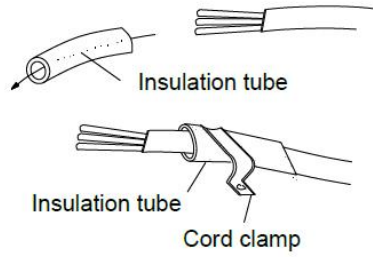

## 2.8.5 Electric Wiring between the Indoor and Outdoor Units

Duct Type Unit: 1-  
phase:TCHB136J0T-LTL105:

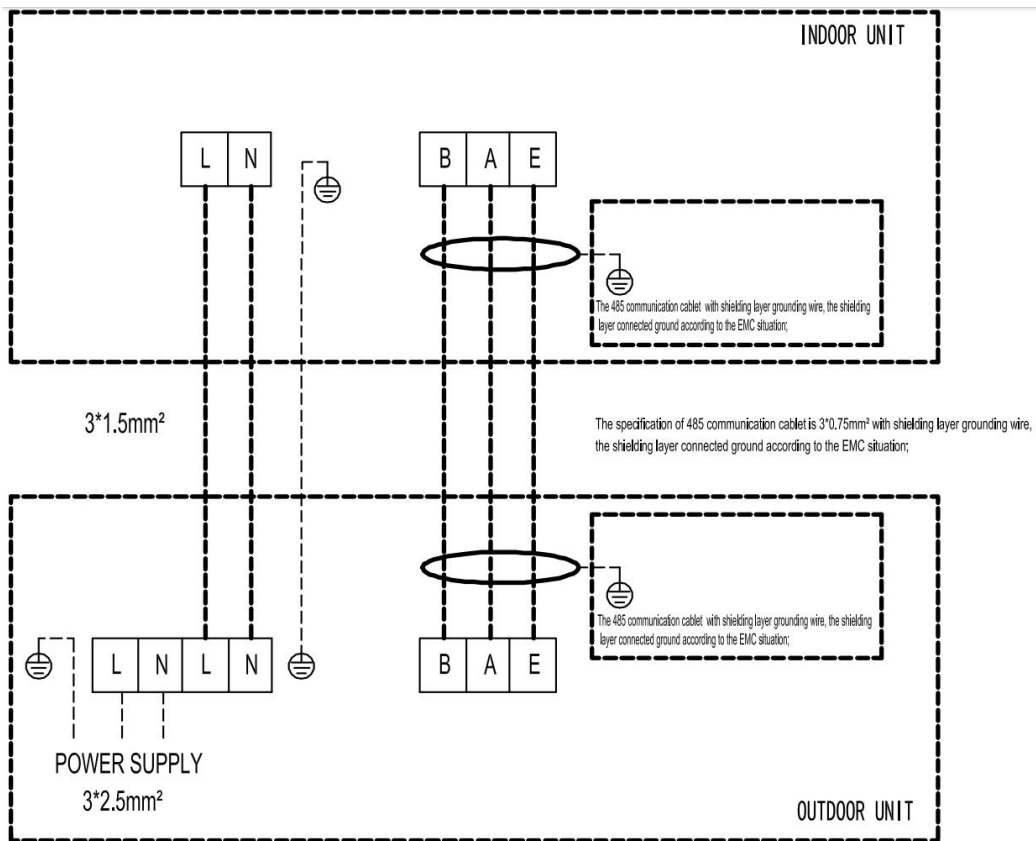

Duct Type Unit:  
3-phase:48K/55K:

Duct Type Unit: 3-  
phase:TCHB160J7T-LTL160:

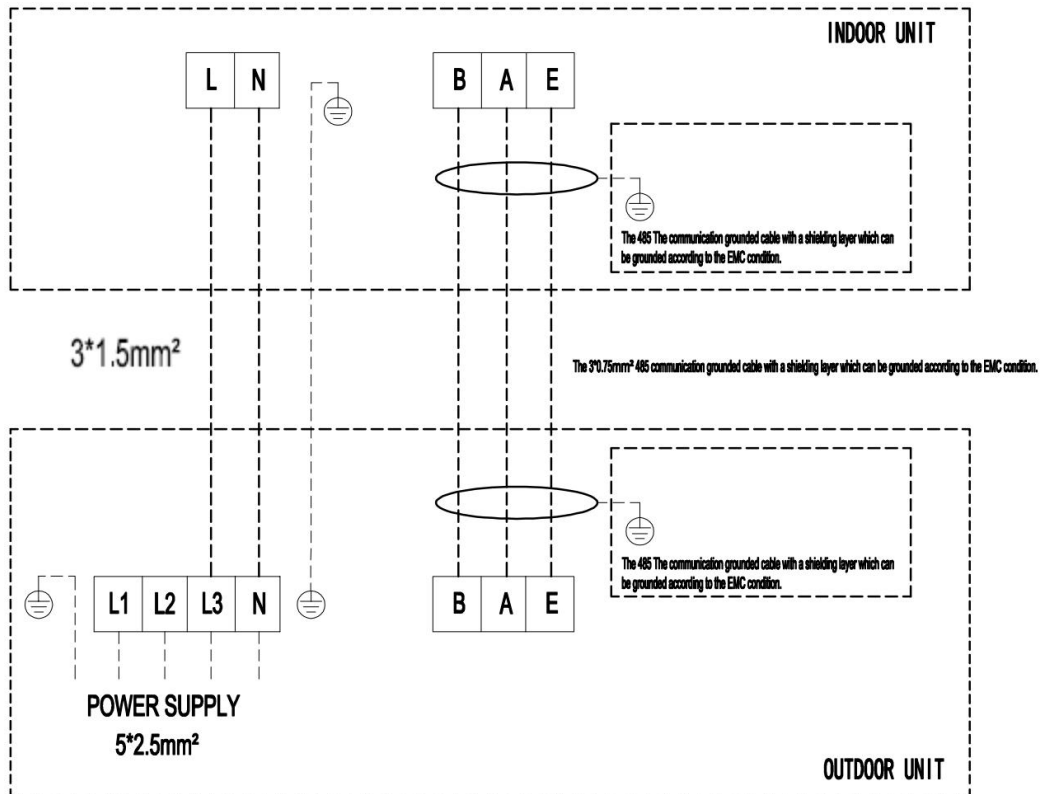



## 2.8.6 Electric Wiring of Outdoor Unit Side

- 1) Remove the electric cover of the outdoor unit.
- 2) Connect the power connection cord to the terminal board. Wiring should fit that of indoor unit.
- 3) Fix the power connection cord with wire clamp.
- 4) Confirm if the wire has been fixed properly.
- 5) An efficient earth connection must be ensured.
- 6) Recover the control box cover.

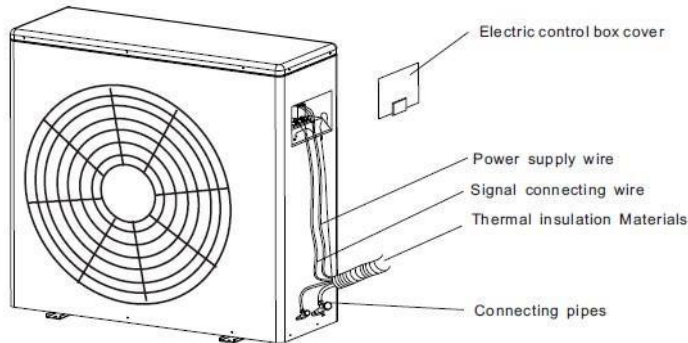

**NOTICE:** When connecting the power supply cord, make sure that the phase of the power supply matches with the exact terminal board. If not, the compressor will rotate reversely and run improperly.

## 2.8.7 Electric Wiring of Indoor Unit Side

### 2.8.7.1 Prepare The Cable For Connection

- 1) Using wire strippers, strip the rubber jacket from both ends of signal cable to reveal about 15cm (5.9") of the wires inside.
- 2) Strip the insulation from the ends of the wires.
- 3) Using a wire crimper, crimp u-lugs on the ends of the wires.

### 2.8.7.2 Wiring Instructions

#### Duct Type Unit:

- 1) Remove the electric cover of the outdoor unit.
- 2) Thread the power cable and the signal cable through the wire outlet rubber ring of the box.
- 3) Connect the power connection cord to the terminal board. Wiring should fit that of outdoor unit.
- 4) Fix the power connection cord with wire clamp.
- 5) Confirm if the wire has been fixed properly.
- 6) An efficient earth connection must be ensured.
- 7) Reinstall the electric cover of the indoor unit.
- 8) Wrap the power cable, signal cable and the piping together with binding tape.

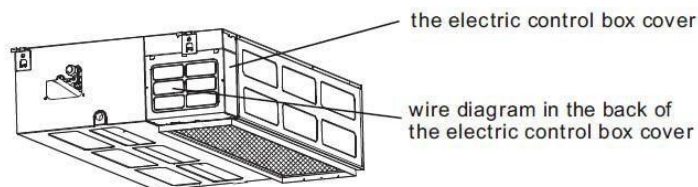

## 2.9 Test Operation

### 2.9.1 Precaution

The test run needs to be performed after the entire system is completely installed. Before performing the test, please confirm the following points:

- 1)The indoor unit and outdoor unit are installed correctly according to the instructions.
- 2)The electrical wiring is properly connected.
- 3)Make sure there are no obstacles near the air conditioner. These obstacles may cause the air conditioner to malfunction or degrade performance.
- 4)The refrigeration system has no leakage.
- 5)The drain pipe has been installed as required.

**Note:** Failure to perform the test run may result in unit damage, property damage or even personal injury.

### 2.9.2 Test Run Instructions

- 1) Open both the liquid and gas stop valves.
- 2) Turn on the main power switch and allow the unit to warm up.
- 3) Set the air conditioner to COOL mode.
- 4) For the Indoor Unit
  - Ensure the remote control and its buttons work properly.
  - Double check to see if the room temperature is being registered correctly.
  - Ensure the indicators on the remote control and the remote controller receiver work properly.
  - Ensure the manual buttons on the indoor unit works properly.
  - Check to see that the drainage system is unimpeded and draining smoothly.
  - Ensure there is no vibration or abnormal noise during operation.
- 5) For the Outdoor Unit
  - Check to see if the refrigeration system is leaking.
  - Make sure there is no vibration or abnormal noise during operation.
  - Ensure the wind, noise, and water generated by the unit do not disturb your neighbors or pose a safety hazard.

**NOTE:** If the unit malfunctions or does not operate according to your expectations, please refer to the Troubleshooting section of the Owner's Manual before calling customer service.

## 3. Maintenance

### 3.1 Display Board

#### 3.1.1 Icon Explanation on Indoor Display Board (Cassette Type)

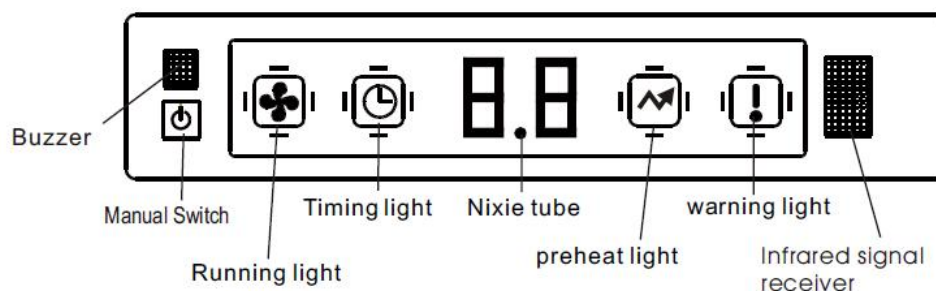

#### 3.1.2 Icon Explanation on Indoor Display Board (Duct Type)

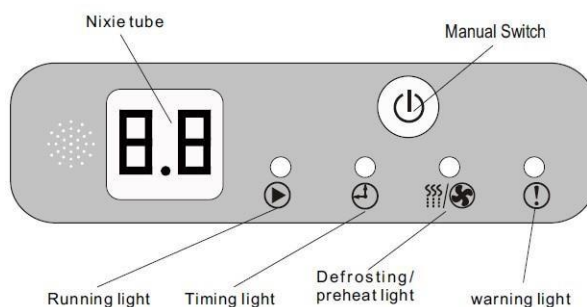

### 3.2 Failure code

Error Code	Error Content	Error History Times	Error Definition and Protection
E0	Indoor and outdoor communication failure	1	Hardware Error
E1	Indoor ambient temperature sensor failure	2	Hardware Error
E2	Indoor fan coil temperature sensor failure	3	Hardware Error
E3	Outdoor fan coil temperature sensor failure	4	Hardware Error
E4	Abnormal system malfunction (lack of fluorine) <sup>5</sup>	5	Hardware Error
E5	Model configuration error	6	Hardware Error
E6	Indoor PG/DC fan failure	7	Hardware Error
E7	Outdoor ambient temperature sensor failure	8	Hardware Error
E8	Outdoor exhaust temperature sensor failure	9	Hardware Error
E9	Outdoor IPM module failure/compressor drive failure	10	Hardware Error
EA	Outdoor current sensor failure	11	Hardware Error
Eb	PCB and display screen communication failure	12	Hardware Error
EC	Outdoor modules Communication failure	13	Hardware Error
EE	Outdoor EEPROM fault	14	Hardware Error
EF	Outdoor DC fan failure	15	Hardware Error
EH	Outdoor suction sensor failure	16	Hardware Error
EP	Outdoor compressor casing top failure	17	Hardware Error
EU	Outdoor voltage sensor failure	18	Hardware Error
Ej	Outdoor central coil temperature sensor failure	30	Hardware Error
En	Outdoor air pipe temperature sensor failure	31	Hardware Error
Ey	Outdoor liquid pipe temperature sensor failure	32	Hardware Error
P0	IPM module protection	19	Others Error
P1	Overvoltage and undervoltage protection	20	Others Error
P2	Overcurrent protection	21	Others Error
P3	Other protections	22	Others Error
P4	Protection against excessive outdoor exhaust temperature	23	Others Error
P5	Cooling protection against overcooling	24	Others Error
P6	Cooling and anti overheating protection	25	Others Error

p7	Heating and anti overheating protection	26	Others Error
p8	Protection against high or low outdoor temperature	27	Remote control display adjustment
p9	Compressor drive protection (abnormal load)	28	Others Error
PA	Communication failure/ mode conflict	29	Others Error
F0	Infrared human sensing sensor failure	33	Remote control display adjustment
F1	Battery module failure	34	Remote control display adjustment
F2	Exhaust temperature sensor failure protection	35	Others Error
F3	Failure protection of outer tube temperature sensor	36	Others Error
F4	Abnormal protection of refrigerant circulation	37	Others Error
F5	PFC protection	38	Others Error
F6	Compressor missing/ reverse phase protection	39	Others Error
F7	Module temperature protection	40	Others Error
F8	Abnormal commutation of four-way valve	41	Others Error
F9	Module temperature sensor circuit malfunction	42	Hardware Error
FA	Compressor phase current detection fault	43	Hardware Error
Fb	Cooling and heating overload protection limit frequency reduction	44	Remote control display adjustment
FC	High power protection limit/frequency reduction	45	Remote control display adjustment
FE	Module current (compressor phase current) protection limit/frequency reduction	46	Remote control display adjustment
FF	Module temperature protection limit/ frequency reduction	47	Remote control display adjustment
FH	Drive protection limit/frequency reduction	48	Remote control display adjustment
FP	Anti condensation protection limit/frequency reduction	49	Remote control display adjustment
FU	Anti freezing protection limit/frequency reduction	50	Remote control display adjustment
Fj	Exhaust protection limit/ frequency reduction	51	Remote control display adjustment
Fn	External AC current protection limit/frequency reduction	52	Remote control display adjustment
Fy	Fluorine deficiency protection	53	Others Error
H1	High pressure switch malfunction	54	Hardware Error
H2	Low pressure switch malfunction	55	Hardware Error
bf	TVOC sensor failure	56	Remote control display adjustment

bc	PM2.5 sensor failure	57	Remote control display adjustment
bj	Humidity sensor failure	58	Remote control display adjustment
bE	CO2 sensor malfunction	59	Hardware Erro
bd	Fresh air fan failure	60	Hardware Erro
d4	Water full protection	61	Others Erro
d5	Access control protection	62	Hardware Erro

### 3.3 Trouble Shooting

#### 3.3.1 E0 --IDU & ODU communication failure

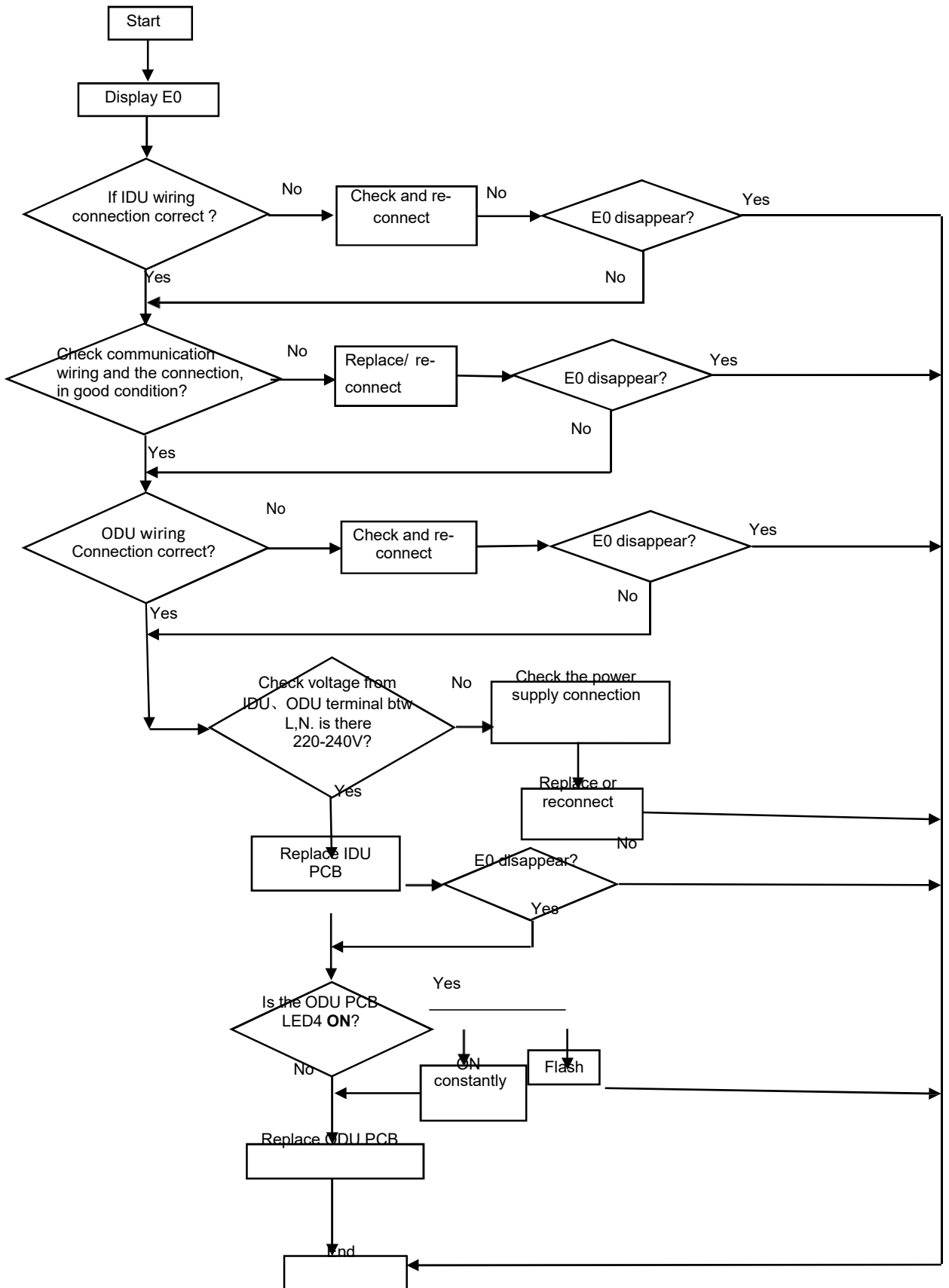

3.3.2E1, E2 ---IDU Room temperature sensor and/or coil temperature sensor failure.

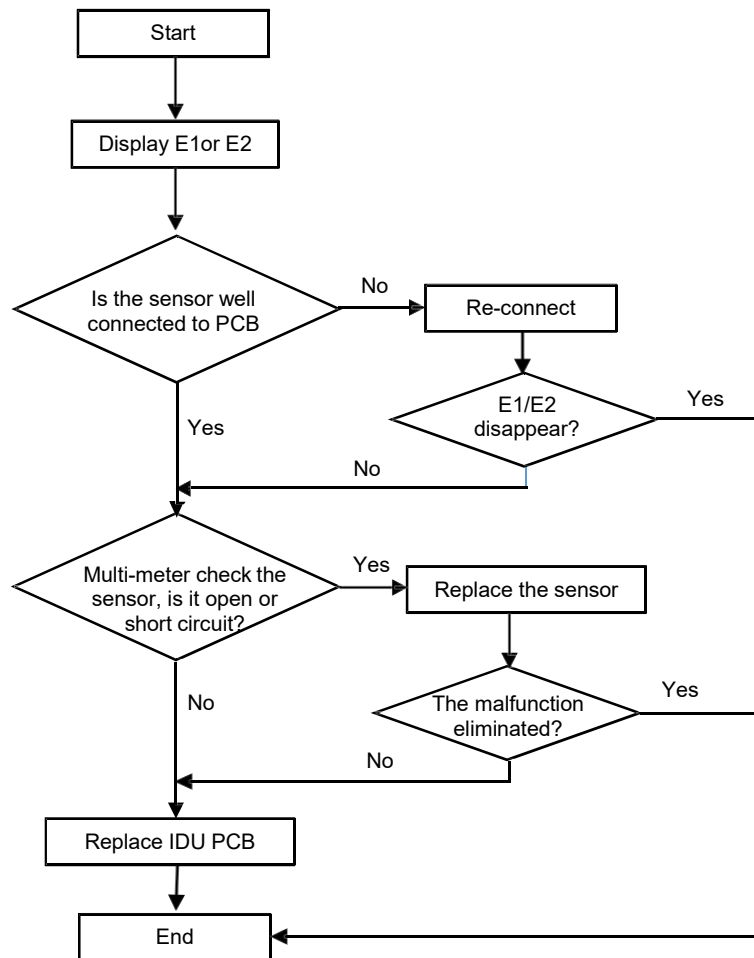

**3.3.3E6----IDU ventilation failure (PG and DC fan motor only)**

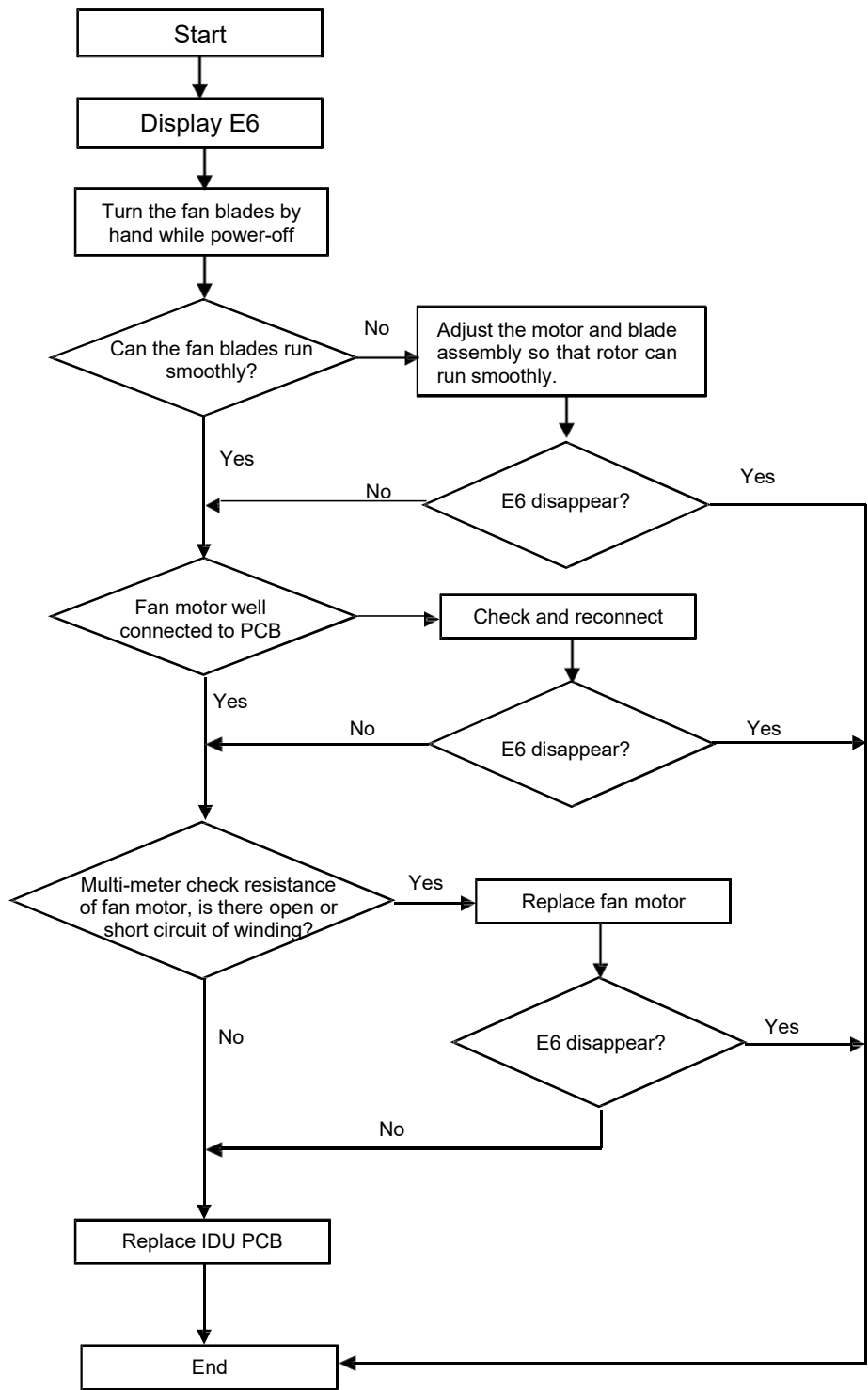



### 3.3.4 E3, E7 or E8---ODU Coil temperature sensor, Ambient temperature sensor or Discharge temperature sensor failure.

When any of the sensor resistance open or short circuit , unit will display failure code as E3/E7 or E8, IDU and ODU turns off. When the sensor resistance recovery, unit revert to be standby, customer can switch on the unit directly.

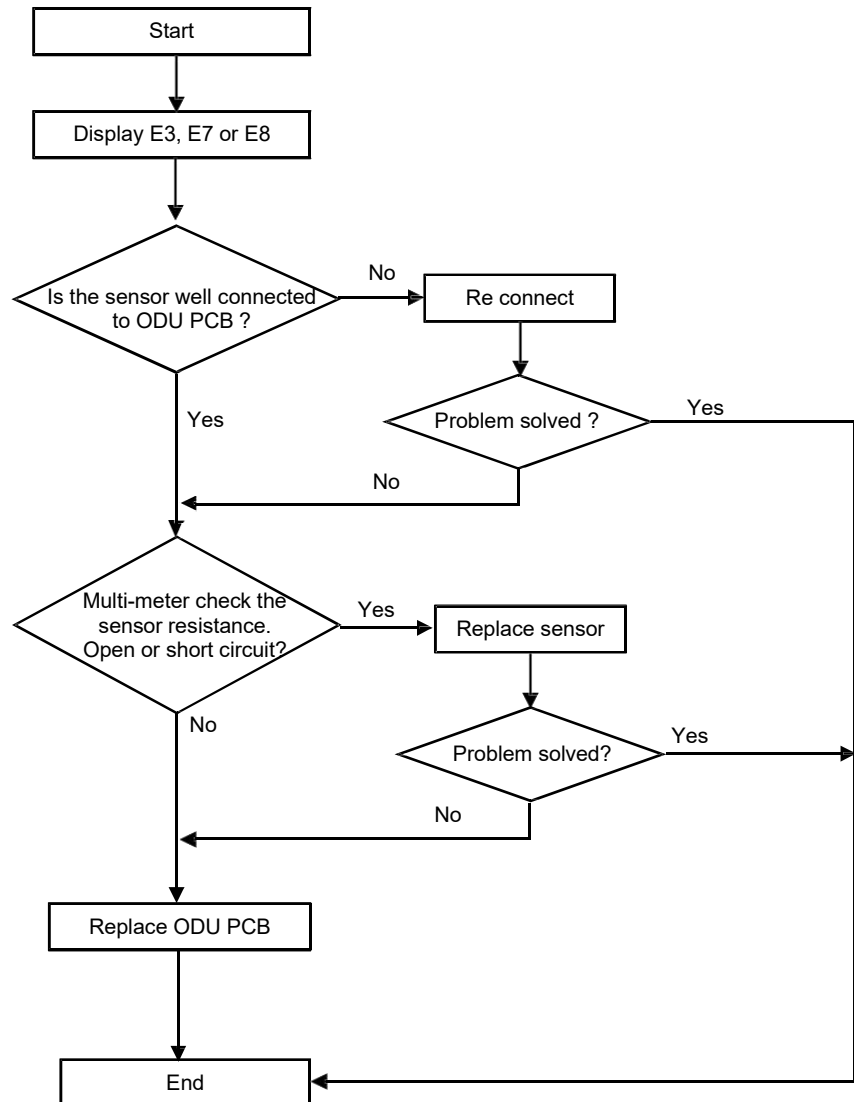

### 3.3.5 EF---ODU DC fan motor failure

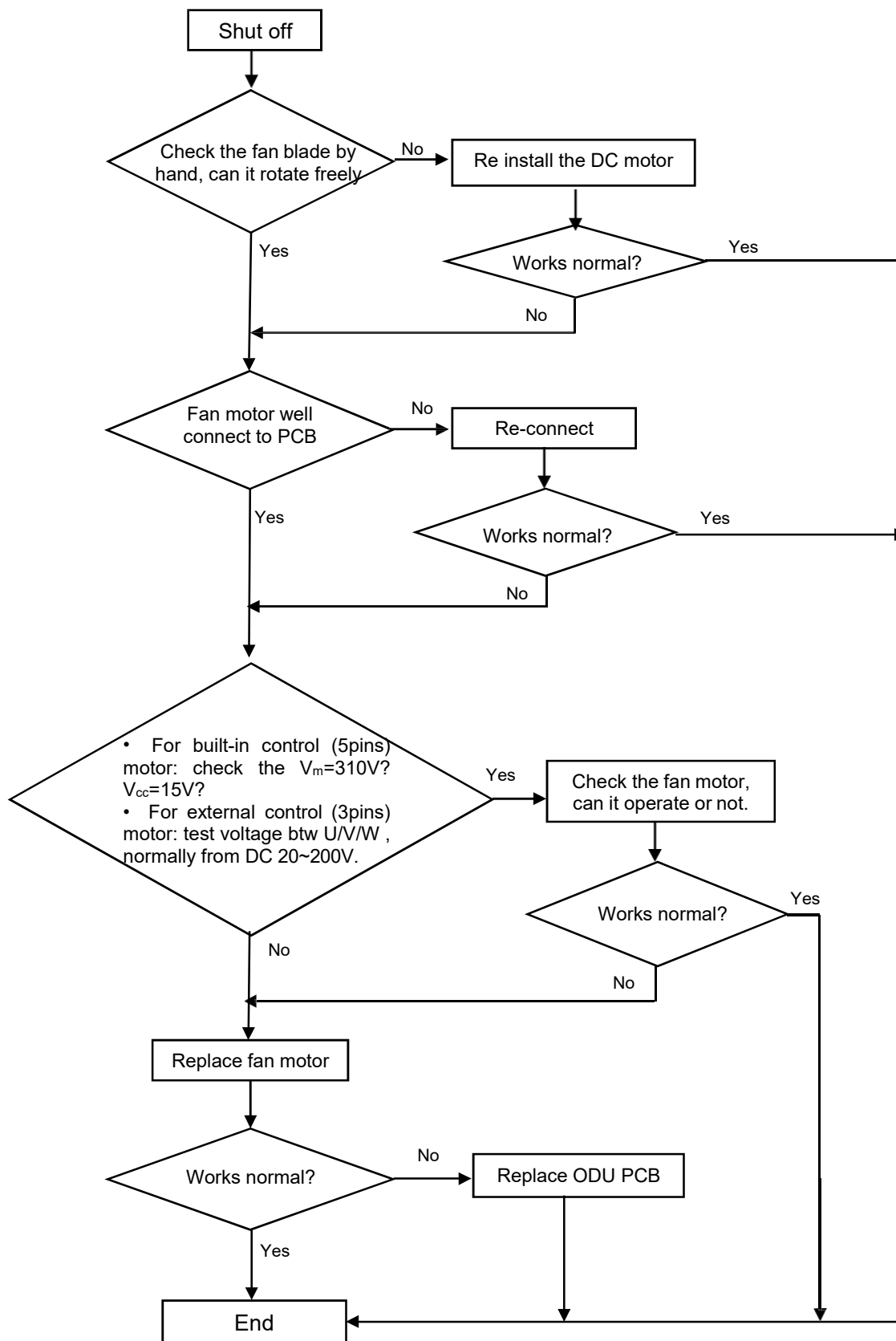

### 3.3.6 P0---IPM protection

When overheat or overcurrent for IPM, AC unit will display P0 protection.

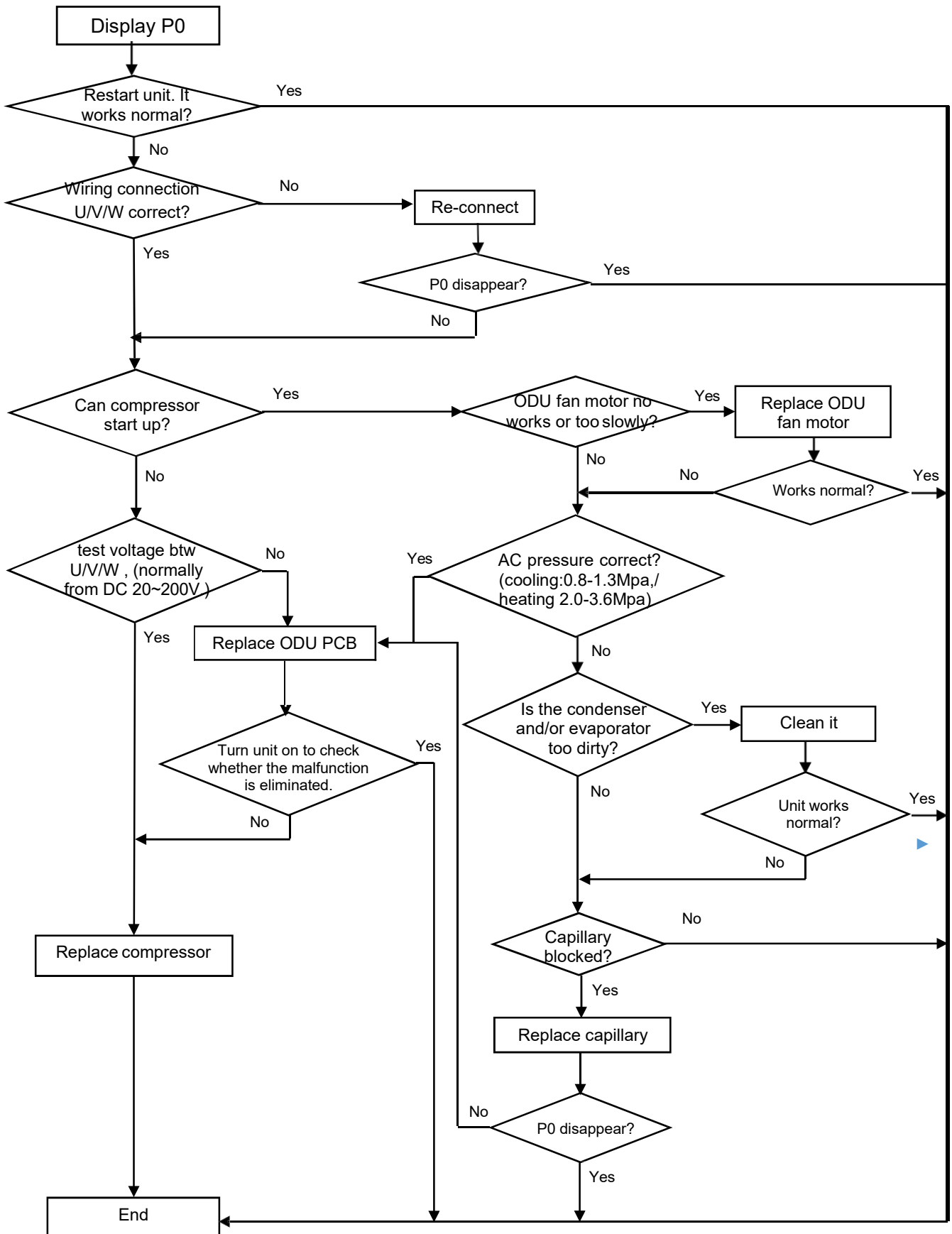

### 3.3.7 J8,J9--- Over / under voltage protection

- Test voltage between L &N, When the power supply  $V > AC260V$  or  $V < AC150V$ , AC will display J8 or J9 protection, unit will recover back to previous status while  $V > AC155V$ .
- Test voltage on the big size electrolytic capacitor of ODU PCB, When DC busbar voltage  $V > DC420V$  or  $V < DC150V$ , unit will recover back to previous status while  $DC190V < V < DC410V$

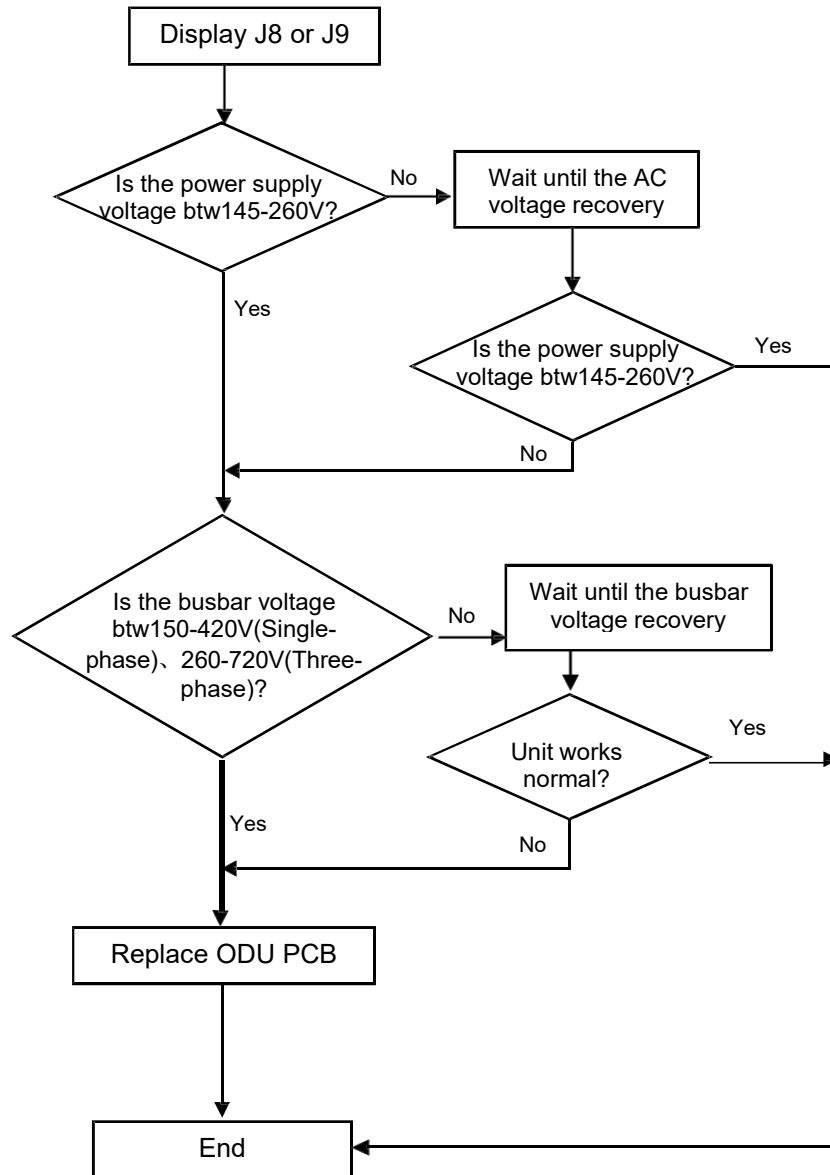

### 3.3.8 P2---Over Current protection

When the AC unit running current more than  $I_{max}$ , it will stop and display P2 protection.

Note: for different AC model,  $I_{max}$  has difference value.

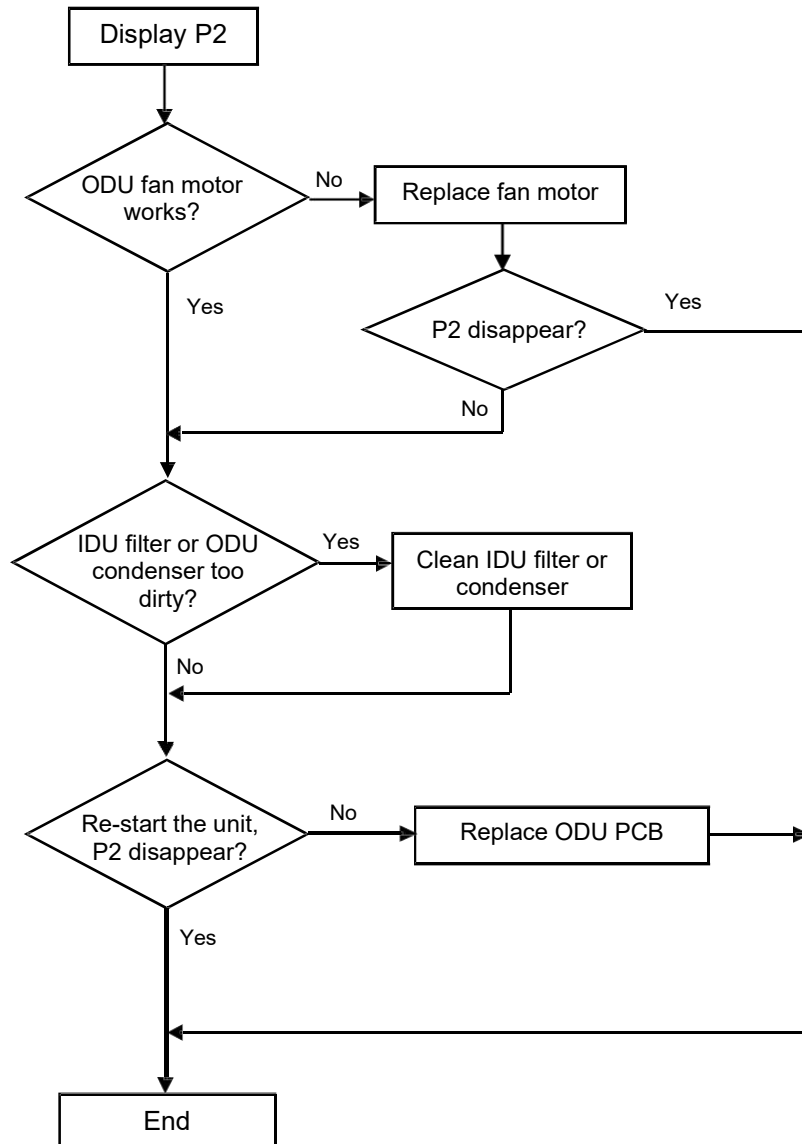

### 3.3.9 P4 ---ODU Discharge temperature overheating protection

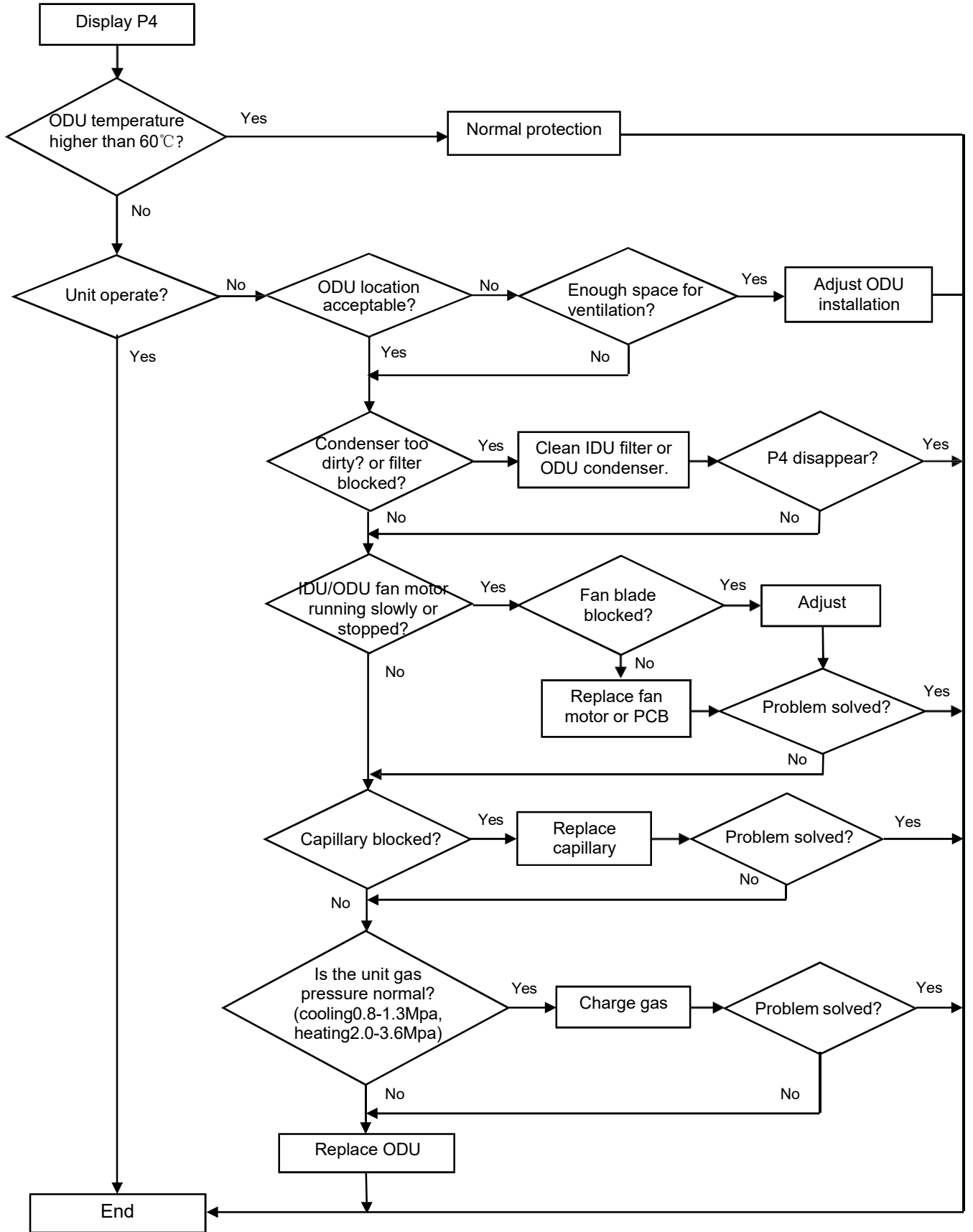

### 3.3.10 P5---Sub-cooling protection on Cooling/Dry mode

On Cooling or Dry mode, when IDU evaporator coil temperature IPT < 1°C continuously for 3 min after compressor start up for 6 min, CPU will switch off outdoor unit and show P5 failure code.

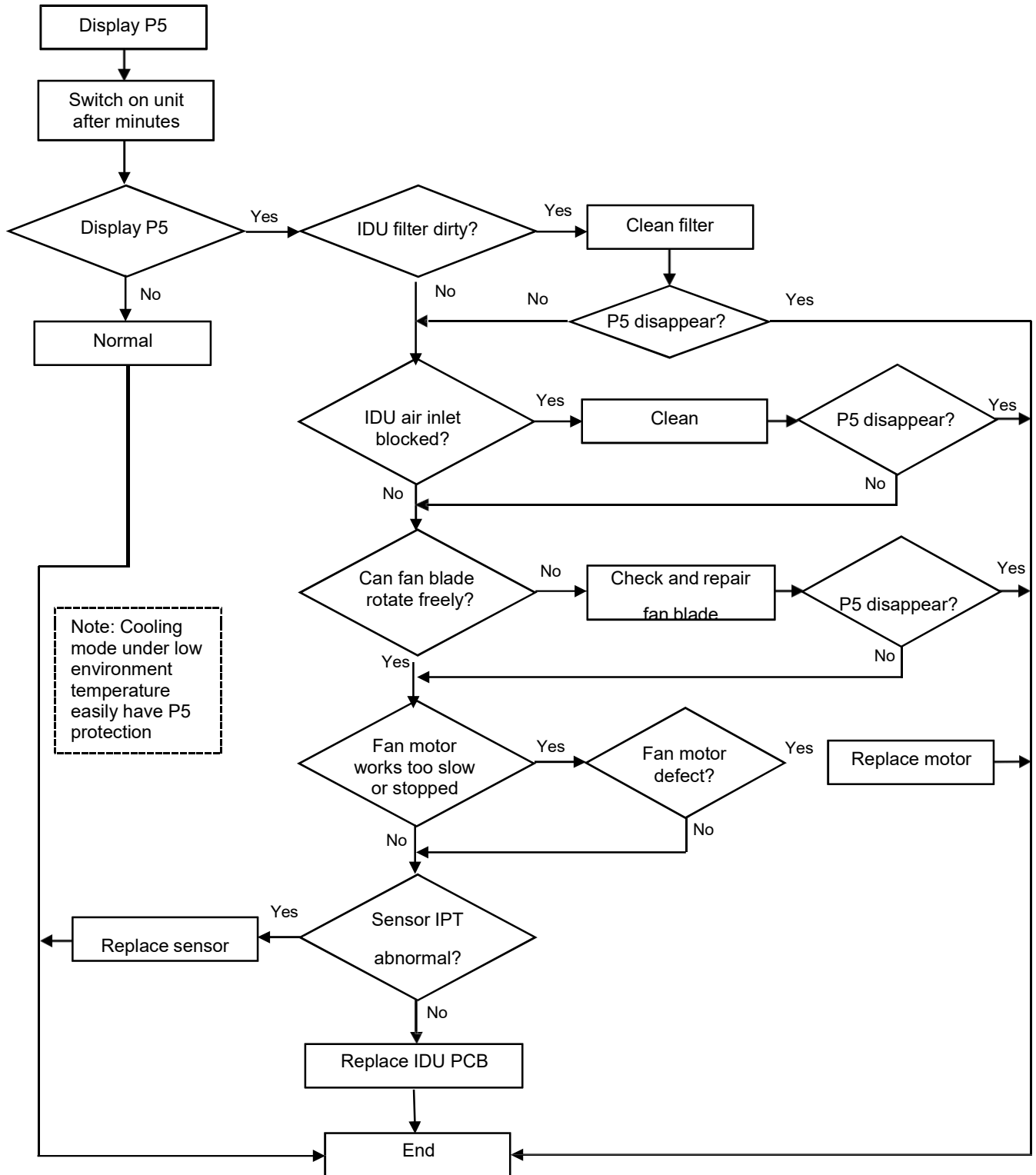

### 3.3.11 P6---Overheating protection on Cooling mode

On Cooling or Dry mode, when ODU condenser coil temperature  $OPT \geq 65^{\circ}\text{C}$  ( $149^{\circ}\text{F}$ ) , MCU will switch off outdoor unit and show P6 failure code.

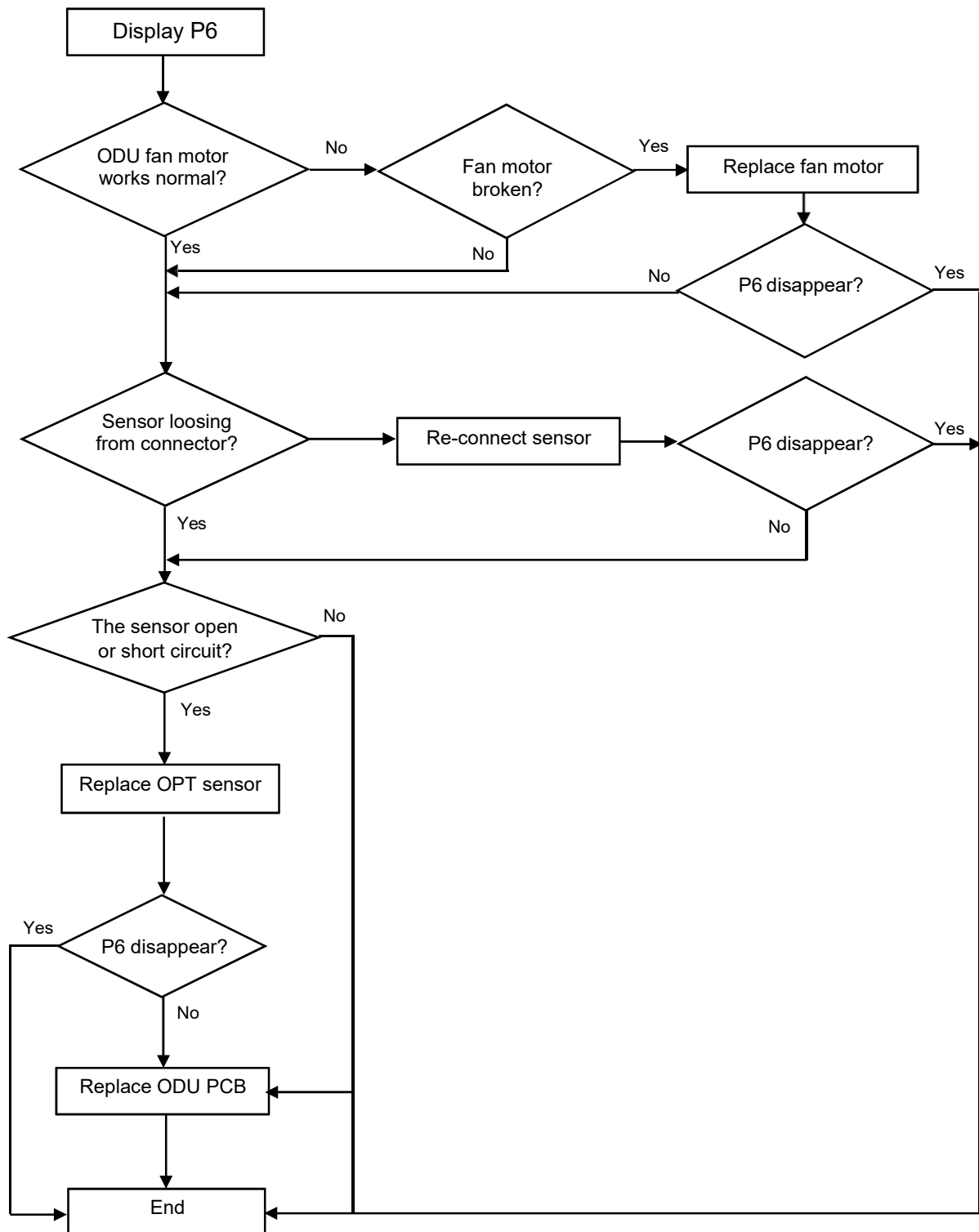



### 3.3.12 P7---Overheating protection on Coolingmode

On heating mode, when IDU evaporator coil temperature  $IPT \geq 64^{\circ}\text{C}$  ( $147.2^{\circ}\text{F}$ ), ODU PCB will switch off outdoor unit and show P7 failure code.

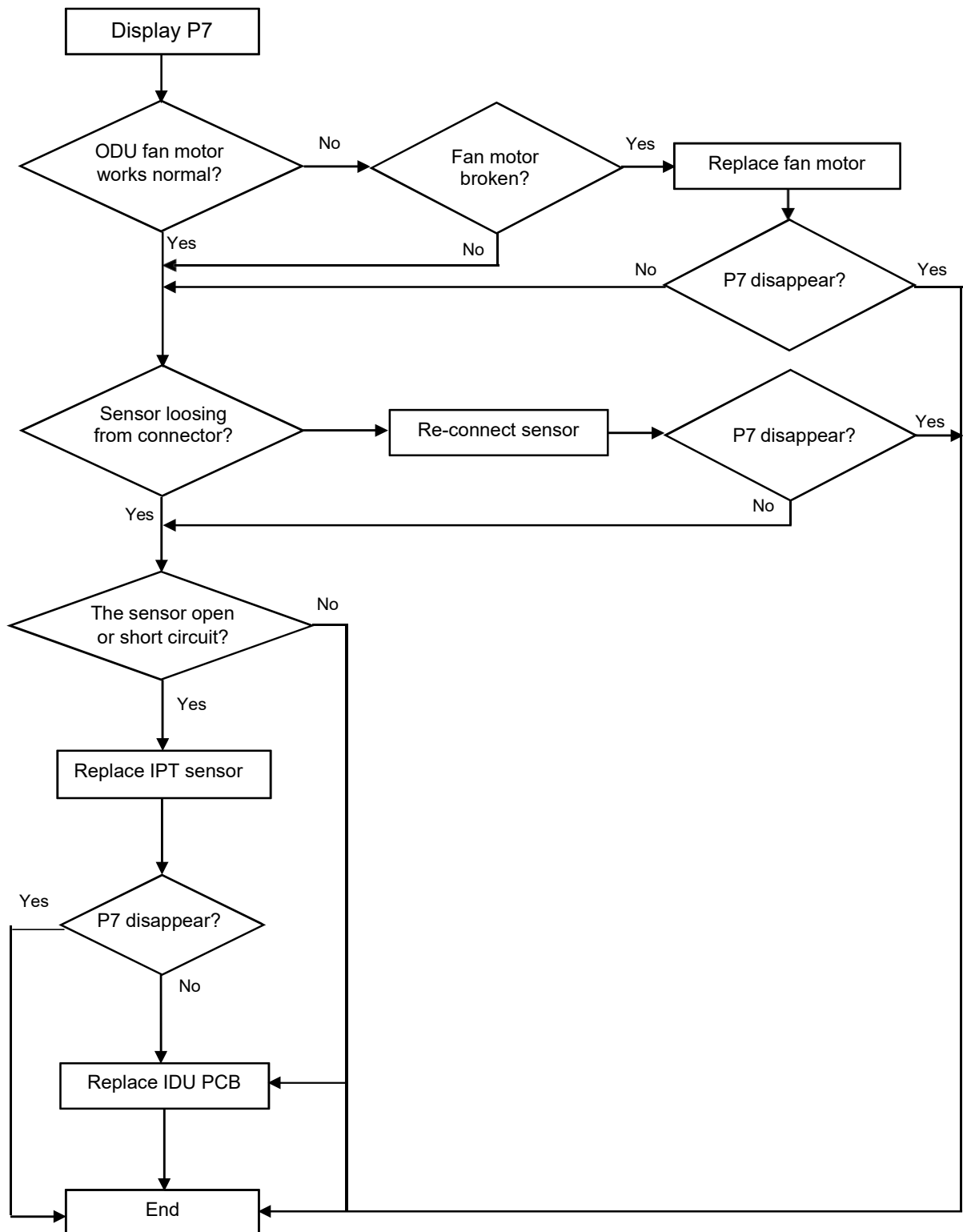

### 3.3.13 P8---Outdoor Overtemperature/Under-temperature protection

When environment temperature as below condition, the compressor will stop working, after 200s delay, the IDU will show P8 failure code.

- (1). **On Cooling or Dry mode:** ODU ambient temperature:  $OAT < -15^{\circ}\text{C}$  ( $5^{\circ}\text{F}$ ) or  $OAT > 60^{\circ}\text{C}$  ( $140^{\circ}\text{F}$ );
- (2). **On Heating mode:**  
 $OAT \geq 40^{\circ}\text{C}$  ( $104^{\circ}\text{F}$ )

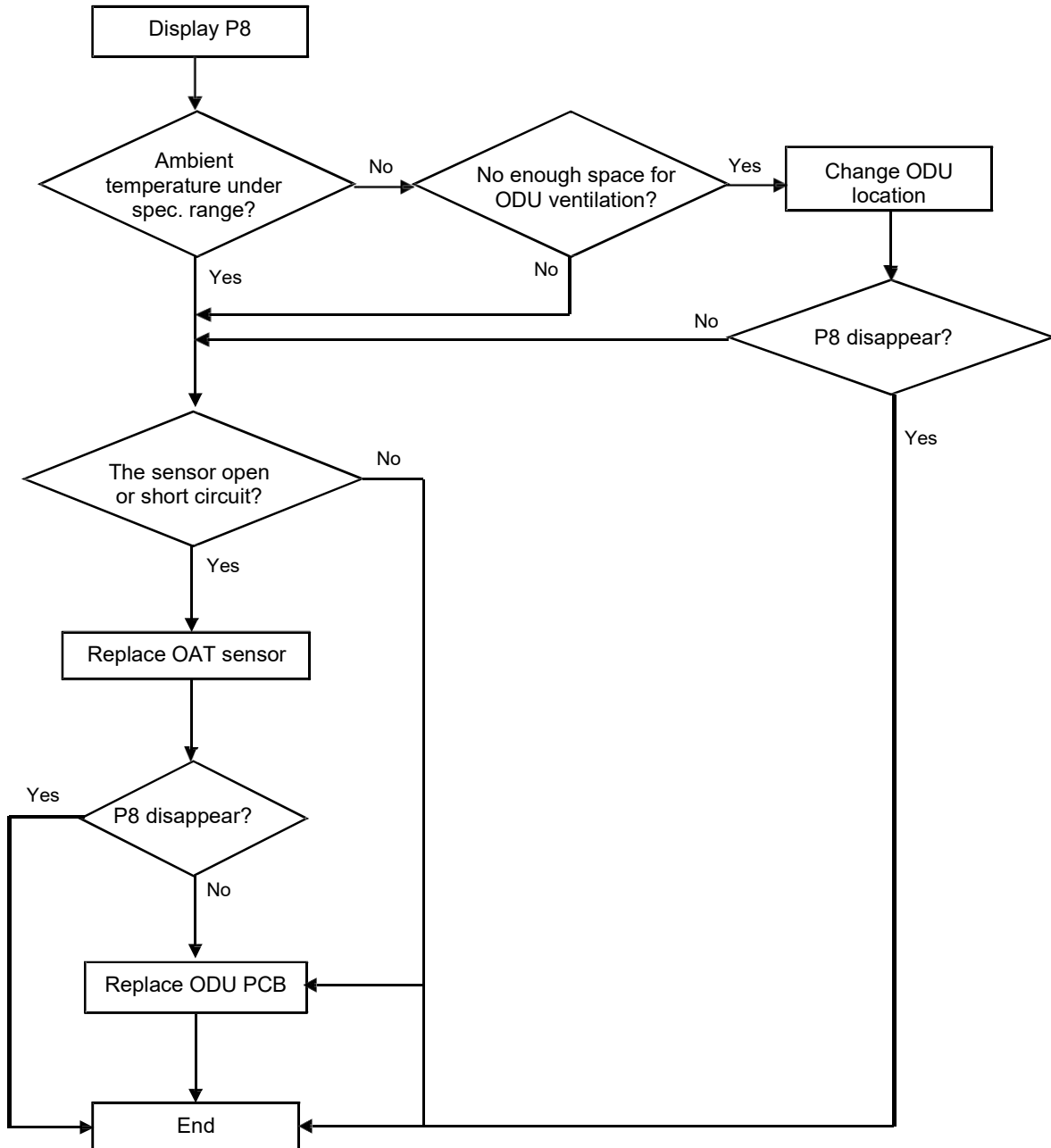

### 3.3.14 HE The Compressor Lack of phase / Anti-phase protection.

If ODU PCB can't test one, or even three phase of compressor current, it will show HE protection.

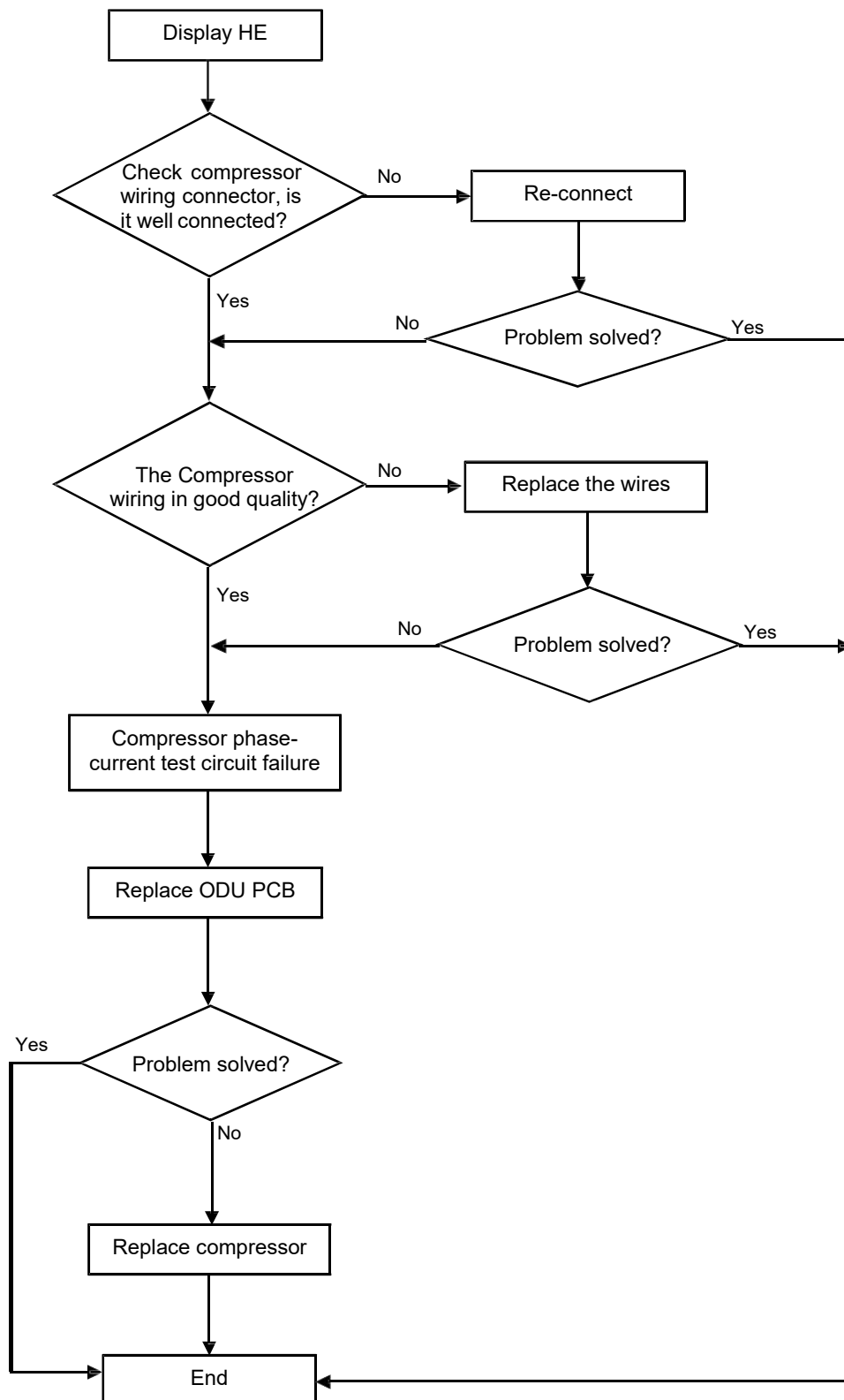

### 3.3.15 J6---Module temperature protection.

IPM overtemperature protection, when IPM temperature more than 95°C, it will show J6.

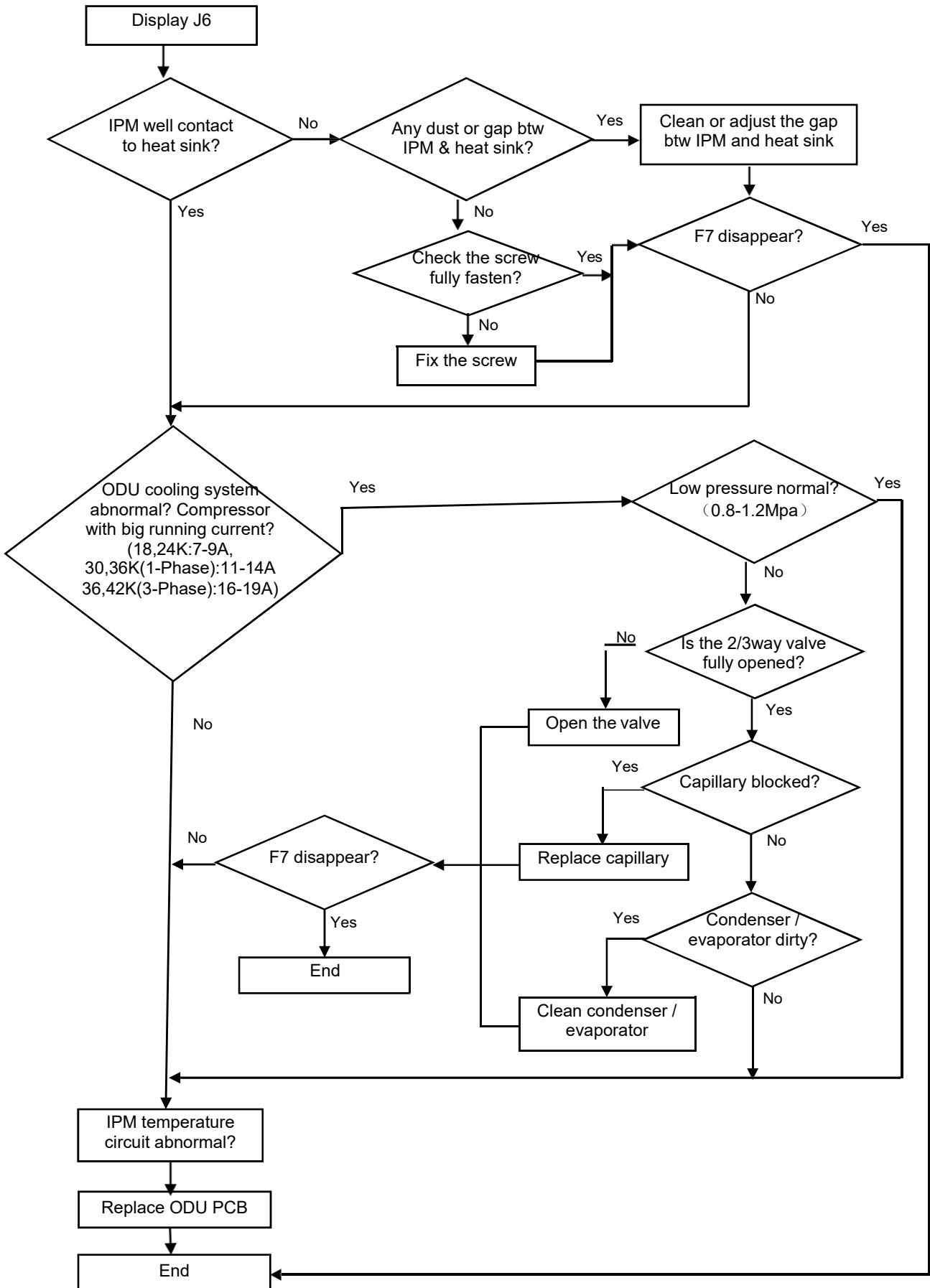

### 3.3.16 H6--- Gas leakage protection

After compressor works in high frequency for 9 min, if the temperature on IDU evaporator & ODU condenser has only a little variation comparing previous, but, the compressor discharge temperature on high level, then the unit will show H6 failure code.

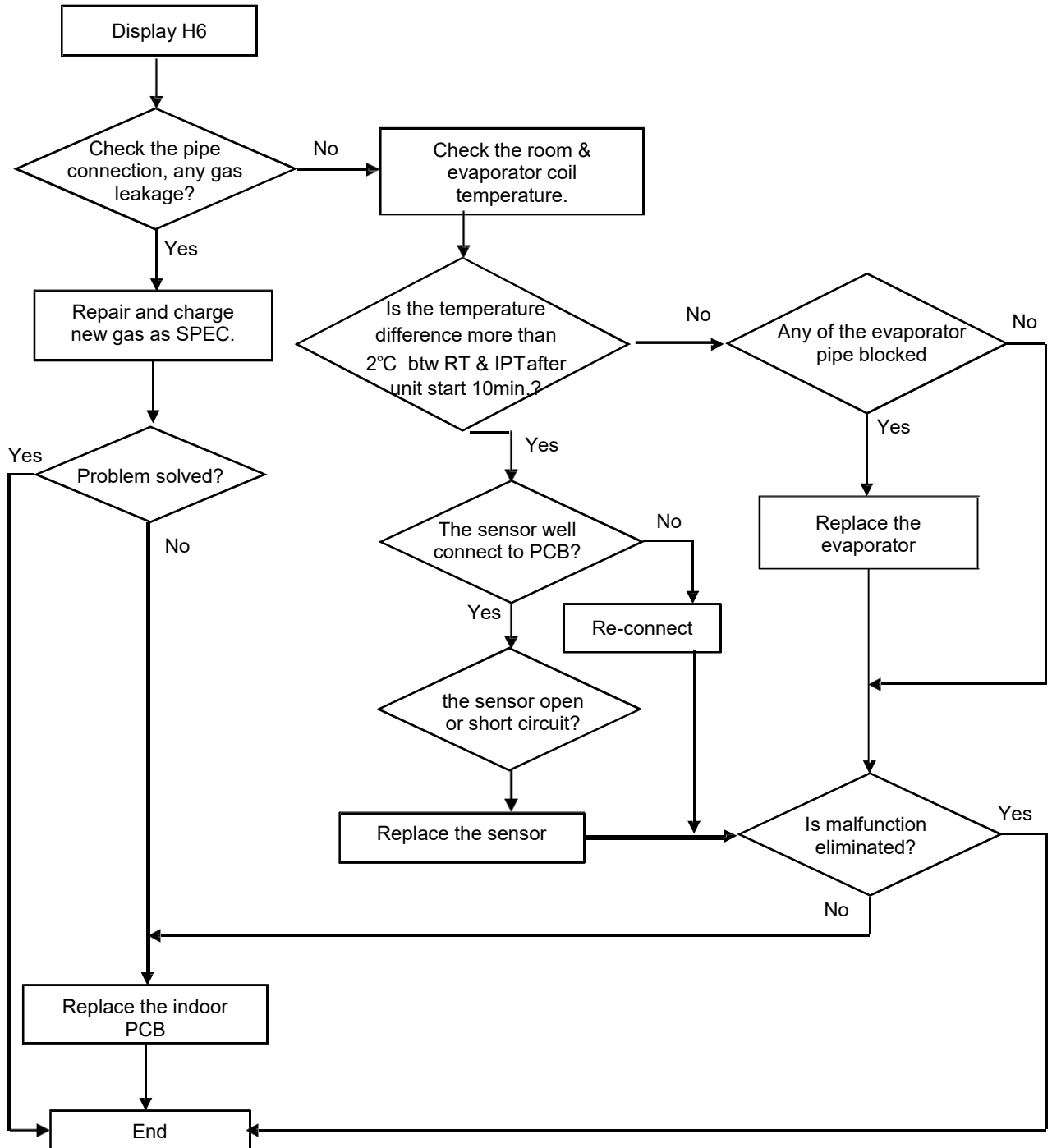

## APPENDIX

### Appendix 1 The Comparison Table of Celsius-Fahrenheit Temperature

Fahrenheit display temperature (°F)	Fahrenheit(°F)	Celsius (°C)	Fahrenheit display temperature (°F)	Fahrenheit (°F)	Celsius (°C)	Fahrenheit display temperature (°F)	Fahrenheit(°F)	Celsius (°C)
61	60.8	16	69/70	69.8	21	78/79	78.8	26
62/63	62.6	17	71/72	71.6	22	80/81	80.6	27
64/65	64.4	18	73/74	73.4	23	82/83	82.4	28
66/67	66.2	19	75/76	75.2	24	84/85	84.2	29
68	68	20	77	77	25	86	86	30

### Appendix 2 Temperature Sensor Resistance Value Table (°C--K)

°C	K Ohm	°C	K Ohm	°C	K Ohm	°C	K Ohm
-20	115.266	20	12.6431	60	2.35774	100	0.62973
-19	108.146	21	12.0561	61	2.27249	101	0.61148
-18	101.517	22	11.5000	62	2.19073	102	0.59386
-17	96.3423	23	10.9731	63	2.11241	103	0.57683
-16	89.5865	24	10.4736	64	2.03732	104	0.56038
-15	84.2190	25	10.0000	65	1.96532	105	0.54448
-14	79.3110	26	9.55074	66	1.89627	106	0.52912
-13	74.5360	27	9.12445	67	1.83003	107	0.51426
-12	70.1698	28	8.71983	68	1.76647	108	0.49989
-11	66.0898	29	8.33566	69	1.70547	109	0.48600
-10	62.2756	30	7.97078	70	1.64691	110	0.47256
-9	58.7079	31	7.62411	71	1.59068	111	0.45957
-8	56.3694	32	7.29464	72	1.53668	112	0.44699
-7	52.2438	33	6.98142	73	1.48481	113	0.43482
-6	49.3161	34	6.68355	74	1.43498	114	0.42304
-5	46.5725	35	6.40021	75	1.38703	115	0.41164
-4	44.0000	36	6.13059	76	1.34105	116	0.40060
-3	41.5878	37	5.87359	77	1.29078	117	0.38991
-2	39.8239	38	5.62961	78	1.25423	118	0.37956
-1	37.1988	39	5.39689	79	1.21330	119	0.36954
0	35.2024	40	5.17519	80	1.17393	120	0.35982
1	33.3269	41	4.96392	81	1.13604	121	0.35042
2	31.5635	42	4.76253	82	1.09958	122	0.3413

3	29.9058	43	4.57050	83	1.06448	123	0.33246
4	28.3459	44	4.38736	84	1.03069	124	0.32390
5	26.8778	45	4.21263	85	0.99815	125	0.31559
6	25.4954	46	4.04589	86	0.96681	126	0.30754
7	24.1932	47	3.88673	87	0.93662	127	0.29974
8	22.5662	48	3.73476	88	0.90753	128	0.29216
9	21.8094	49	3.58962	89	0.87950	129	0.28482
10	20.7184	50	3.45097	90	0.85248	130	0.27770
11	19.6891	51	3.31847	91	0.82643	131	0.27078
12	18.7177	52	3.19183	92	0.80132	132	0.26408
13	17.8005	53	3.07075	93	0.77709	133	0.25757
14	16.9341	54	2.95896	94	0.75373	134	0.25125
15	16.1156	55	2.84421	95	0.73119	135	0.24512
16	15.3418	56	2.73823	96	0.70944	136	0.23916
17	14.6181	57	2.63682	97	0.68844	137	0.23338
18	13.9180	58	2.53973	98	0.66818	138	0.22776
19	13.2631	59	2.44677	99	0.64862	139	0.22231

### Appendix 3

Unit: °C---K		Discharge temperature sensortable					
-20	542.7	20	68.66	60	13.59	100	3.702
-19	511.9	21	65.62	61	13.11	101	3.595
-18	483	22	62.73	62	12.65	102	3.492
-17	455.9	23	59.98	63	12.21	103	3.392
-16	430.5	24	57.37	64	11.79	104	3.296
-15	406.7	25	54.89	65	11.38	105	3.203
-14	384.3	26	52.53	66	10.99	106	3.113
-13	363.3	27	50.28	67	10.61	107	3.025
-12	343.6	28	48.14	68	10.25	108	2.941
-11	325.1	29	46.11	69	9.902	109	2.86
-10	307.7	30	44.17	70	9.569	110	2.781
-9	291.3	31	42.33	71	9.248	111	2.704
-8	275.9	32	40.57	72	8.94	112	2.63
-7	261.4	33	38.89	73	8.643	113	2.559
-6	247.8	34	37.3	74	8.358	114	2.489
-5	234.9	35	35.78	75	8.084	115	2.422
-4	222.8	36	34.32	76	7.82	116	2.357
-3	211.4	37	32.94	77	7.566	117	2.294
-2	200.7	38	31.62	78	7.321	118	2.233
-1	190.5	39	30.36	79	7.086	119	2.174
0	180.9	40	29.15	80	6.859	120	2.117
1	171.9	41	28	81	6.641	121	2.061
2	163.3	42	26.9	82	6.43	122	2.007
3	155.2	43	25.86	83	6.228	123	1.955
4	147.6	44	24.85	84	6.033	124	1.905
5	140.4	45	23.89	85	5.844	125	1.856
6	133.5	46	22.89	86	5.663	126	1.808
7	127.1	47	22.1	87	5.488	127	1.762
8	121	48	21.26	88	5.32	128	1.717

9	115.2	49	20.46	89	5.157	129	1.674
10	109.8	50	19.69	90	5	130	1.632
11	104.6	51	18.96	91	4.849		
12	99.69	52	18.26	92	4.703		
13	95.05	53	17.58	93	4.562		
14	90.66	54	16.94	94	4.426		
15	86.49	55	16.32	95	4.294	B(25/50)=3950K	
16	82.54	56	15.73	96	4.167		
17	78.79	57	15.16	97	4.045	R(90°C)=5KΩ±3%	
18	75.24	58	14.62	98	3.927		
19	71.86	59	14.09	99	3.812		

#### Appendix 4

Normal voltage of P and N			
208-240V(1-phase,3-phase)		380-415V(3-phase)	
In standby			
around 310VDC		around 530VDC	
In operation			
With passive PFC module	With partial active PFC module	With fully active PFC module	/
>200VDC	>310VDC	>370VDC	>450VDC





**OMEGA**  
ENVIRONMENTAL  
TECHNOLOGIES LLC.

17702 Mitchell North, #101  
Irvine, CA. 92614 .USA  
Tel: 714 795 2830  
Fax: 714 966 1646  
info@omegavrf.com  
www.omegavrf.com

**OTEC**<sup>TM</sup>  
AIR CONDITIONING

**Showroom & Technology Center**  
11380 Interchange Circle North  
Miramar, FL 33025 .USA  
Tel: 305 901 1270  
Fax: 954 212 8280  
info@otecomega.com  
www.otecomega.com

TELP(MP)T0A-LM1D0724