

# VNMF Series MINI VRF Service Manual

**220-240V/1/50-60Hz**

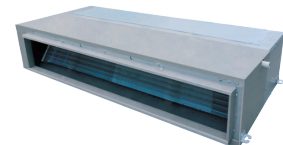
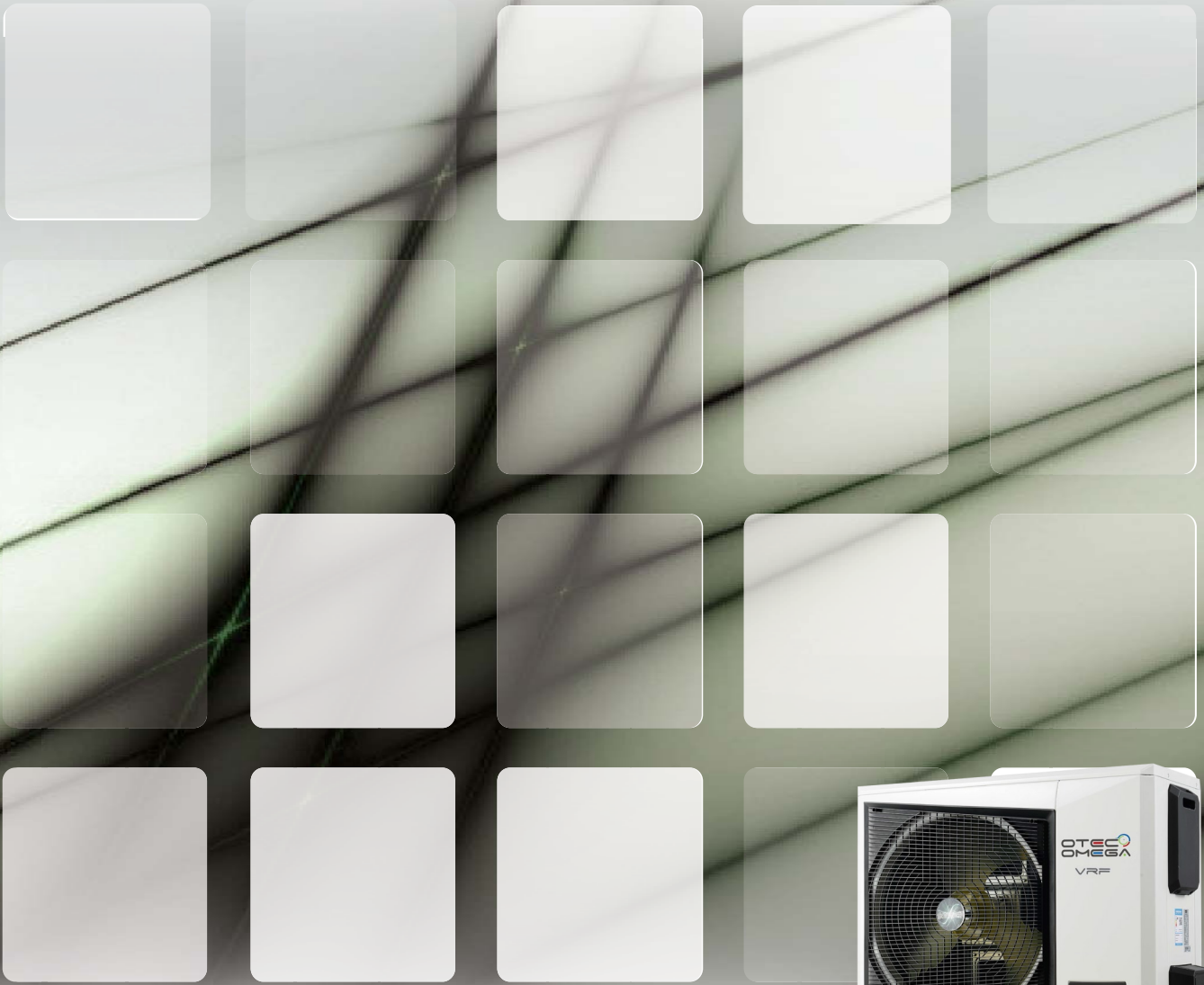

# CONTENTS

Part 1 General Information .....	3
Part 2 Outdoor Units .....	12
Part 3 Installation .....	65
Part 4 Troubleshooting .....	81

# Part 1

## General Information

- 1 Indoor and Outdoor Unit Capacities ..... 4
- 2 External Appearance..... 5
- 3 Nomenclature..... 7
- 4 Combination Ratio..... 7
- 5 Features..... 8

Part 1 - General Information

# VNMF Mini VRF 50/60Hz

## 1.

### 1.1 Outdoor Units

Table 1-1.3: Outdoor unit capacity range

Capacity	8kW	10kW	12.5kW	14kW	16kW
Model	VNMF002Q0A-G04V080	VNMF253Q0A-G05V100	VNMF003Q0A-G06V125	VNMF004Q0A-G07V140	VNMF345Q0A-G08V160



## 2. External Appearance

### 2.1 Indoor Units

Table 1-2.1: Standard indoor unit appearance

<p>One-way Cassette VECW</p> 	<p>Two-way Cassette VECT</p> 
<p>Compact Four-way Cassette VECM</p> 	<p>Four-way Cassette VECS</p> 
<p>Round-flow Cassette VECR</p> 	<p>Floor Standing VEFS</p> 
<p>Wall-mounted VEWP</p> 	<p>Floor &amp; Ceiling VEFC</p> 
<p>Low ESP Short Ducted VELP</p> 	<p>Medium ESP Ducted VEMP</p> 
<p>High ESP Ducted VEHP</p> 	

# VNMF Mini VRF 50/60Hz

## 2.2 Outdoor Units *Table 1-2.2: Outdoor unit*

*appearance*

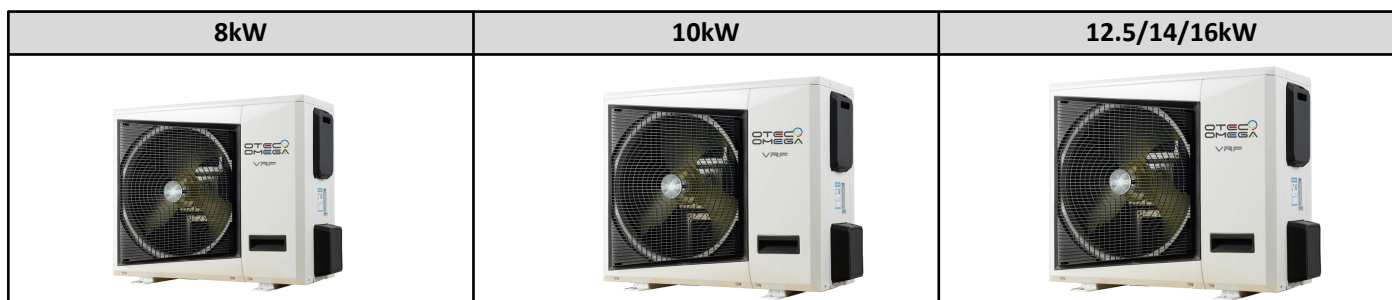

*Table 1-2.3: Outdoor unit specification*

Model name	Net dimension(mm)	Net/Gross weight (kg)	Power supply
VNMF002Q0A-G04V080	Width: 935 Height: 702 Depth: 383	47/50	220~240V/1N/50-60Hz
VNMF253Q0A-G05V100	Width: 1032 Height: 810 Depth: 445	60/65	220~240V/1N/50-60Hz
VNMF003Q0A-G06V125	Width: 1100 Height: 870 Depth: 528	85/95	220~240V/1N/50-60Hz
VNMF004Q0A-G07V140	Width: 1100 Height: 870 Depth: 528	90/100	220~240V/1N/50-60Hz
VNMF345Q0A-G08V160	Width: 1100 Height: 870 Depth: 528	90/100	220~240V/1N/50-60Hz

## 5. Features

### 5.1 Wide application

The All DC Inverter Mini VRF system is a highly efficient solution for small commercial buildings requiring heating and cooling of up to 9 zones with one outdoor unit. Such as villa, restaurant, school etc.

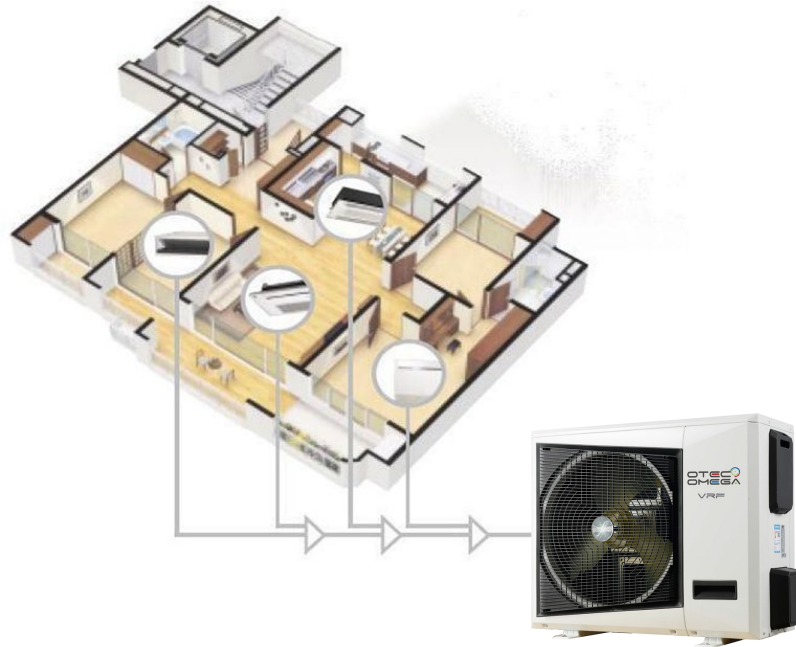

### 5.2 High efficient DC inverter compressor

All DC inverter Mini VRF adopts highly intelligent inverter-driven compressor. This advanced technology enables the output of the outdoor unit to be modulated by the real heat load demands. This advanced system ensures precise temperature regulation and highly efficient energy usage, making a significant contribution to the limiting the impact on the environment.

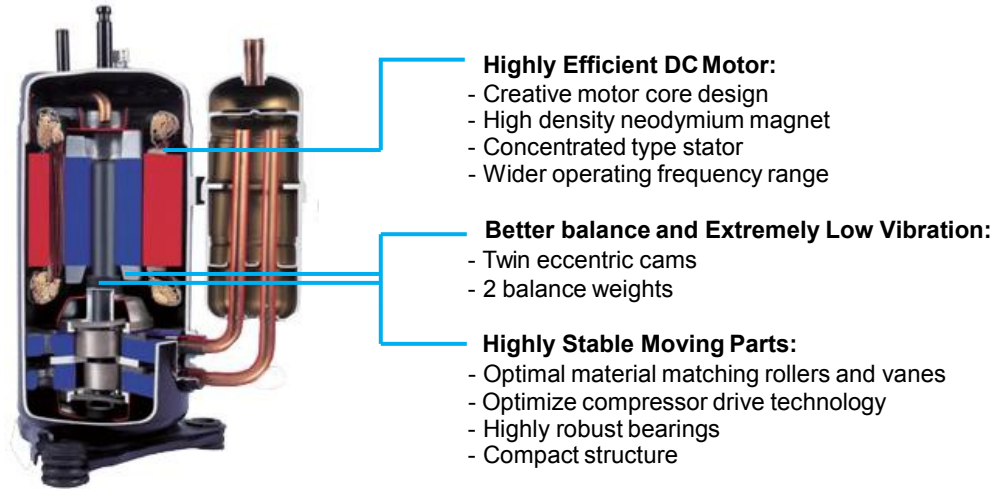

### 5.3 High performance heat exchanger

The new designed window fins enlarge the heat-exchanging area, which decrease the air resistance, save more power and enhance heat exchange performance. Hydrophilic film fins and inner-grooved copper pipes optimize heat exchange efficiency.

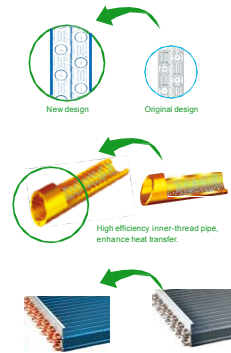

### 5.4 Low-operating sound design

Optimally design fan shape and new designed discharge air grille and air deflector, auxiliary with DC fan motor and world-famous compressor, making higher air volume and lower operation sound.

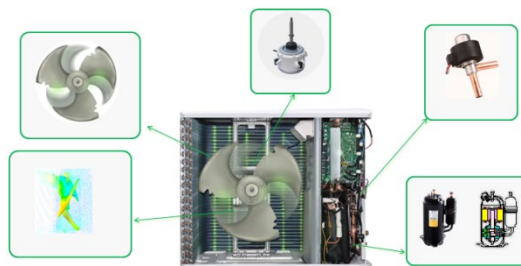

### 5.5 Quick warm-up & cool-down design and less temperature fluctuation

Utilizing the inverter compressor benefits, the system can reach All load quickly and shorten warm-up or cool-down time for an immediate comfortable air solution. Less temperature fluctuation will create a better living environment.

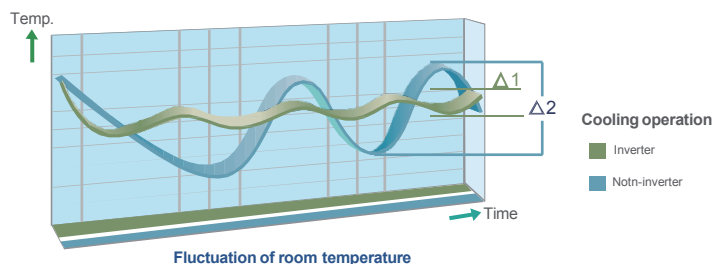

# VNMF Mini VRF 50/60Hz

## 5.6 Wide operation temperature range

No matter in extremely cold winter when outdoor temperature gets as low as -15°C or in hot summer when temperature is up to 55°C, the Mini VRF system will keep stable performance.

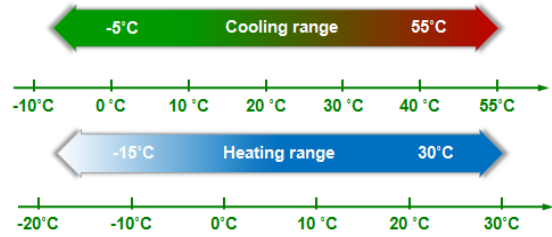

## 5.7 Flexible piping design

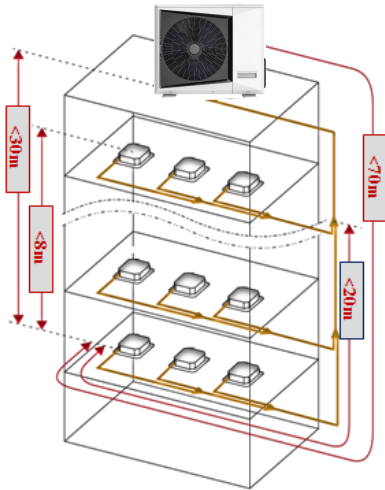
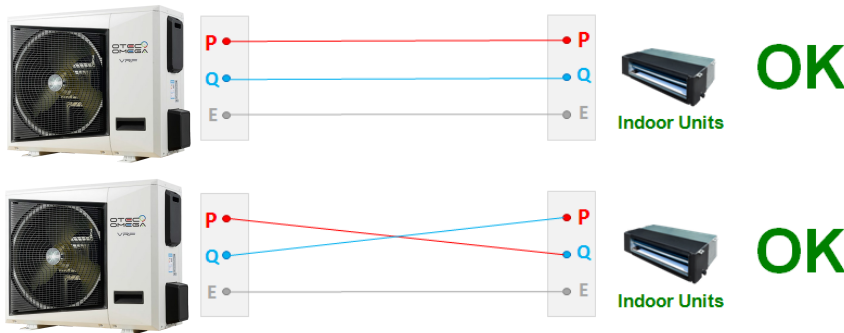

Table 1-5.1: Piping parameters

Piping Length		Permitted Value
Total pipe length		100/120m
Longest pipe length	Actual	60m
	Equivalent	70m
The first distributor to the last IDU		20m
Height difference between IDU~ODU	ODU above	30m
	ODU below	20m
Height difference between IDU~IDU		8m

## 5.8 Simple signal line connection

Installation is much easier as the communication wiring between indoor & outdoor units can be shared. The P and the Q are non-polarity terminals, this is capable to reduce the risk of communication problems and simplify the connecting operation.



## 5.9 Auto address setting function

The addresses of indoor units can be set automatically by outdoor unit. It has capability to reduce artificial faults and manual works.

Wireless controller can enquire and modify the address of each indoor unit.

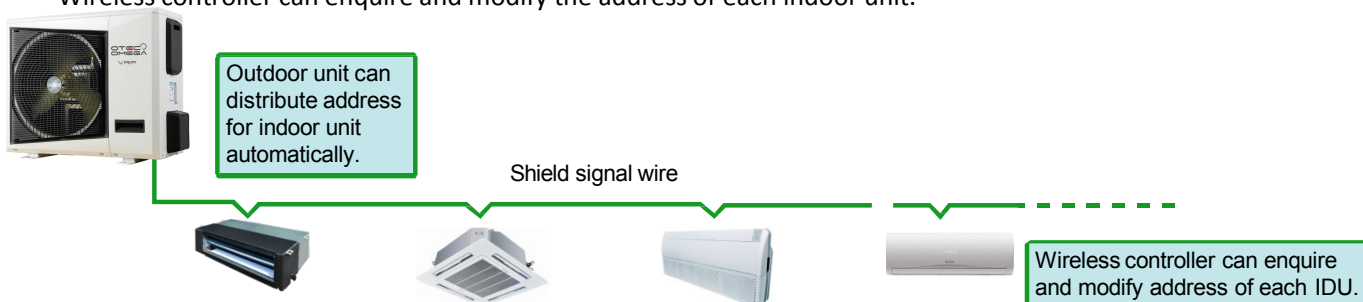

### 5.10 Smart electronic control design

The radiation fin is made of aluminum panels fitting together seamlessly. This helps to cool down the IPM, it has better performance compared to air cooling for PCB.

With PFC(Power Factor Corrector) module, the power utilization rate is increased, the power factor is capable to be 98%, lead to higher efficiency.

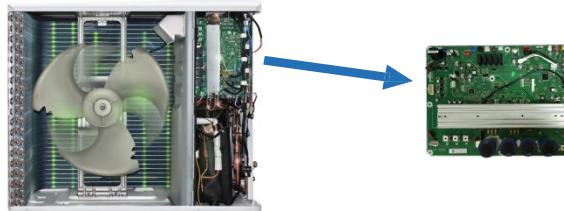

### 5.11 Easy piping connection

Offering four directions to connect pipes and wirings to meet various installation requests.

Also there is a cover protecting the valves.

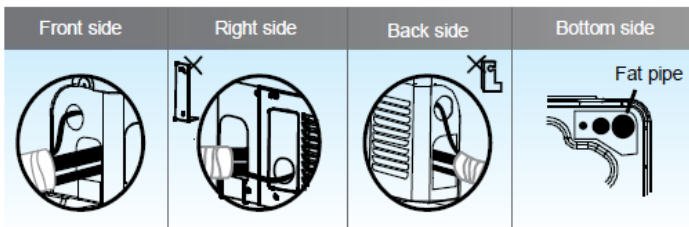
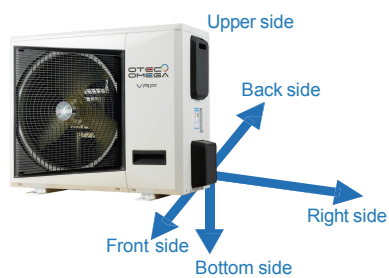

### 5.12 Easy installation

The Mini VRF can be transported by elevator which makes installation dramatically easy, and effectively reduces time and labor thanks to the small size.

The Mini VRF units are more compact, resulting in significant savings in installation space. It is particularly suitable for small offices, villas, shops, etc.

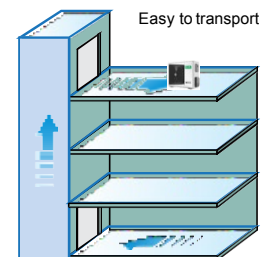

### 5.13 Easy maintenance

Forced cooling button makes outdoor unit run in cooling mode at any condition, so it is very easy for you to charge refrigerant to the system when it needs to be done. The self-diagnosis function detects malfunctions in major locations in the system and displays the type of malfunction and location. This allows service and maintenance to be performed more efficiently.



# Part 2

## Outdoor Units

1	Specifications .....	14
2	Dimensions .....	16
3	Service Space .....	17
4	Piping Diagrams .....	18
5	Wiring Diagrams .....	19
6	Field Wiring .....	21
7	Capacity Tables .....	22
8	Electric Characteristics .....	62
9	Sound Levels .....	63
10	Operation Limits .....	64



# VNMF Mini VRF 50/60Hz

## 1. Specifications

Model name		VNMF002Q0A-G04V080		VNMF253Q0A-G05V100		
Power supply		220~240V/1N/50Hz		220~240V/1N/50Hz		
Condition		T1		T3		
<b>Performance data</b>						
Cooling	Capacity	HP	3		3.6	
		kW	8	7.2	10	9
		Btu/h	27300	24570	34100	30690
		RT	2.27	2.04	2.84	2.56
	Power input	kW	2.60	2.81	3.00	3.25
	Rated current	A	11.8	14.2	13.6	16.4
EER	W/W	3.08	2.56	3.33	2.77	
Heating	Capacity	kW	9		11	
		Btu/h	30700		37500	
		RT	2.56		3.13	
	Power input	kW	2.65		3.10	
	Rated current	A	12.0		14.0	
	COP	W/W	3.39		3.55	
Max. input consumption	kW	3.96		4.40		
Max. current	A	18		20		
Capacity adjustment range		50%~130%		50%~130%		
<b>Compressor data</b>						
DC Inverter compressor	Quantity		1		1	
	Type		Twin-rotary Compressor		Twin-rotary Compressor	
	Brand		Mitsubishi		GMCC	
	Model		SNB200FGMMC		ATM240D57UMT	
	frequency range	Hz	10~120		10~120	
	Crankcase heater	W	25		35	
Compressor oil	Model		FV50S		VG74	
	Original oil volume	ml	400		670	
<b>Fan data</b>						
Fan motor	Type		DC		DC	
	Brand		Yongan		Yongan	
	Model		DRN-310-75-8		DRN-310-90-8	
	Quantity		1		1	
	Insulation class		B		B	
	Protection class		IPX4		IPX4	
	Power output	W	75		90	
Fan blade	Material		ASG20		ASG20	
	Type		Axial		Axial	
	Drive		Direct-driven		Direct-driven	
	Fan Quantity		1		1	
	Air flow	m <sup>3</sup> /h	3300		4000	
<b>Physical data</b>						
Outdoor coil	Fin type		Hydrophilic Aluminum		Hydrophilic Aluminum	
	Tube diameter	mm	Ø7		Ø9.52	
	Number of rows		3		2	
	Coil length x height x width	mm	784×630×40.11		1003×750×43.3	
	Tube type		Inner-grooved copper tube		Inner-grooved copper tube	
Refrigerant	Type		R410a		R410a	
	Volume	kg	2.0		2.6	
	Throttle type		EXV		EXV	
Dimension (W*H*D)	Net	mm	935×702×383		1032x810x445	
	Packing	mm	975×770×420		1075×875×495	
Weight	Net	kg	47		60	
	Gross	kg	50		65	
Outdoor sound level	dB(A)	≤54		≤56		
Maximum operating pressure	MPa	4.5		4.5		
<b>Piping &amp; wiring data</b>						
Pipe size	Liquid pipe	mm	Ø9.52		Ø9.52	
	Gas pipe	mm	Ø15.88		Ø15.88	
Connection wire	Power wire size	mm <sup>2</sup>	3×4.0		3×4.0	
	Signal wire type		3-core shielded cable		3-core shielded cable	
	Signal wire size	mm <sup>2</sup>	1.0		1.0	
<b>Operation temperature range</b>						
Cooling	Outdoor side	°C	-5~55		-5~55	
	Indoor side	°C	16~32		16~32	
Heating	Outdoor side	°C	-15~30		-15~30	
	Indoor side	°C	16~32		16~32	



# VNMF Mini VRF 50/60Hz

Model name		VNMF003Q0A-G06V125		VNMF004Q0A-G07V140		VNMF345Q0A-G08V160		
		220~240V/1N/50Hz		220~240V/1N/50Hz		220~240V/1N/50Hz		
Power supply		220~240V/1N/60Hz		220~240V/1N/60Hz		220~240V/1N/60Hz		
Condition		T1	T3	T1	T3	T1	T3	
<b>Performance data</b>								
Cooling	Capacity	HP	4.5		5		5.7	
		kW	12.5	11.3	14	12.7	16	14.5
		Btu/h	42600	38340	47800	43020	54600	49140
		RT	3.55	3.20	3.98	3.58	4.55	4.10
	Power input	kW	3.20	3.46	3.75	4.06	4.75	5.14
	Rated current	A	14.5	17.5	17.0	20.5	21.8	25.96
EER	W/W	3.74	3.27	3.55	3.13	3.5	2.82	
Heating	Capacity	kW	14		16		17	
		Btu/h	47800		54600		58000	
		RT	3.98		4.55		4.83	
	Power input	kW	3.52		4.00		4.40	
	Rated current	A	16.1		18.2		20.0	
	COP	W/W	3.83		3.72		3.61	
Max. input consumption	kW	7.48		7.48		7.48		
Max. current	A	34		34		34		
Capacity adjustment range		50%~130%		50%~130%		50%~130%		
<b>Compressor data</b>								
DC Inverter compressor	Quantity		1		1		1	
	Type		Twin-rotary Compressor		Twin-rotary Compressor		Twin-rotary Compressor	
	Brand		Mitsubishi		Mitsubishi		Mitsubishi	
	Model		MNB40FEQMC		MNB40FEQMC		MNB40FEQMC	
	frequency range	Hz	10~120		10~120		10~120	
	Crankcase heater	W	35		35		35	
Compressor oil	Model		FV50S		FV50S		FV50S	
	Original oil volume	ml	1100		1100		1100	
<b>Fan data</b>								
Fan motor	Type		DC		DC		DC	
	Brand		Nidec		Nidec		Nidec	
	Model		DR-310-180-8		DR-310-180-8		DR-310-180-8	
	Quantity		1		1		1	
	Insulation class		E		E		E	
	Protection class		IP44		IP44		IP44	
	Power output	W	180		180		180	
Fan blade	Material		ASG20		ASG20		ASG20	
	Type		Axial		Axial		Axial	
	Drive		Direct-driven		Direct-driven		Direct-driven	
	Fan Quantity		1		1		1	
	Air flow	m <sup>3</sup> /h	8000		8000		8000	
<b>Physical data</b>								
Outdoor coil	Fin type		Hydrophilic Aluminum		Hydrophilic Aluminum		Hydrophilic Aluminum	
	Tube diameter	mm	Ø7		Ø7		Ø7	
	Number of rows		2		3		3	
	Coil length x height x width	mm	1145×798×38.8		1145×798×58.2		1145×798×58.2	
Tube type		Inner-grooved copper		Inner-grooved copper		Inner-grooved copper		
Refrigerant	Type		R410a		R410a		R410a	
	Volume	kg	3.0		3.8		3.8	
	Throttle type		EXV		EXV		EXV	
Dimension (W*H*D)	Net	mm	1100×870×528		1100×870×528		1100×870×528	
	Packing	mm	1140×965×540		1140×965×540		1140×965×540	
Weight	Net	kg	85		90		90	
	Gross	kg	95		100		100	
Outdoor sound level	dB(A)	≤56		≤57		≤57		
Maximum operating pressure	MPa	4.5		4.5		4.5		
<b>Piping &amp; wiring data</b>								
Pipe size	Liquid pipe	mm	Ø9.52		Ø9.52		Ø9.52	
	Gas pipe	mm	Ø15.88		Ø15.88		Ø15.88	
Connection wire	Power wire size	mm <sup>2</sup>	3×6.0		3×6.0		3×6.0	
	Signal wire type		3-core shielded cable		3-core shielded cable		3-core shielded cable	
	Signal wire size	mm <sup>2</sup>	1.0		1.0		1.0	
<b>Operation temperature range</b>								
Cooling	Outdoor side	°C	-5~55		-5~55		-5~55	
	Indoor side	°C	16~32		16~32		16~32	
Heating	Outdoor side	°C	-15~30		-15~30		-15~30	
	Indoor side	°C	16~32		16~32		16~32	

## Notes:

- The cooling conditions: indoor side 27°C(80.6°F) DB, 19°C(60°F)WB outdoor side 35°C(95°F) DB.
- The heating conditions: indoor side 20°C(68°F) DB, 15°C(44.6°F)WB outdoor side 7°C(42.8°F)DB.
- Sound level: measured at a point 1 m in front of the unit at a height of 1.5 m. During actual operation, these values are normally somewhat higher as a result of ambient conditions.
- The company reserves the right to revise product technical parameter without having to notify the clients individually.

2. Dimensions

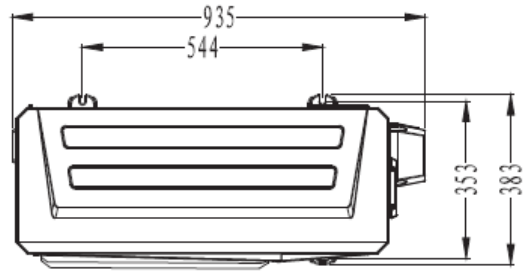
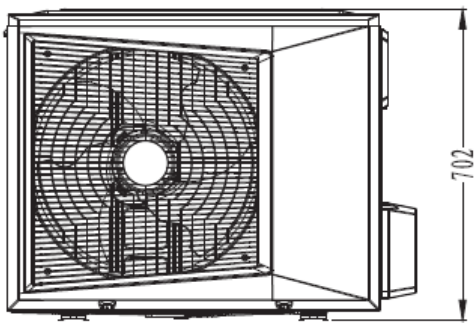

VNMF002Q0A-G04V080

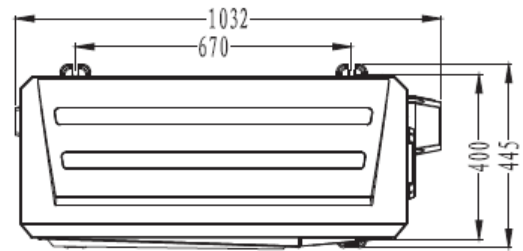
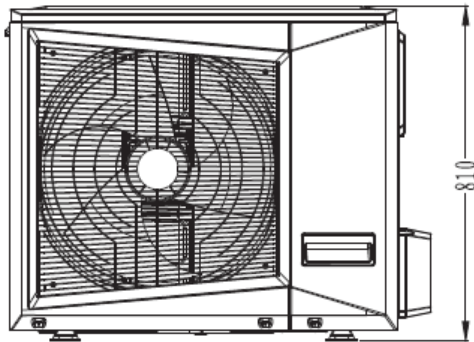

VNMF253Q0A-G05V100

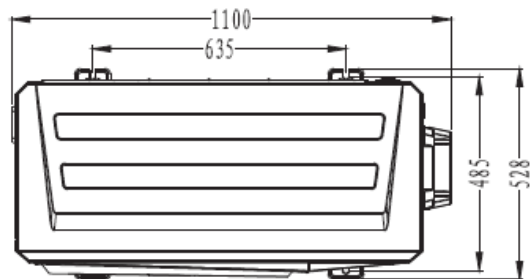
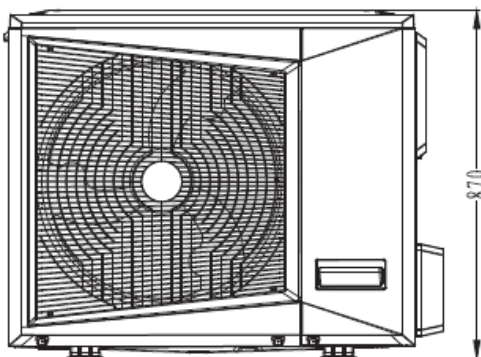

VNMF003Q0A-G06V125  
VNMF004Q0A-G07V140  
VNMF345Q0A-G08V160

### 3. Service Space

#### 3.1 Single unit installation

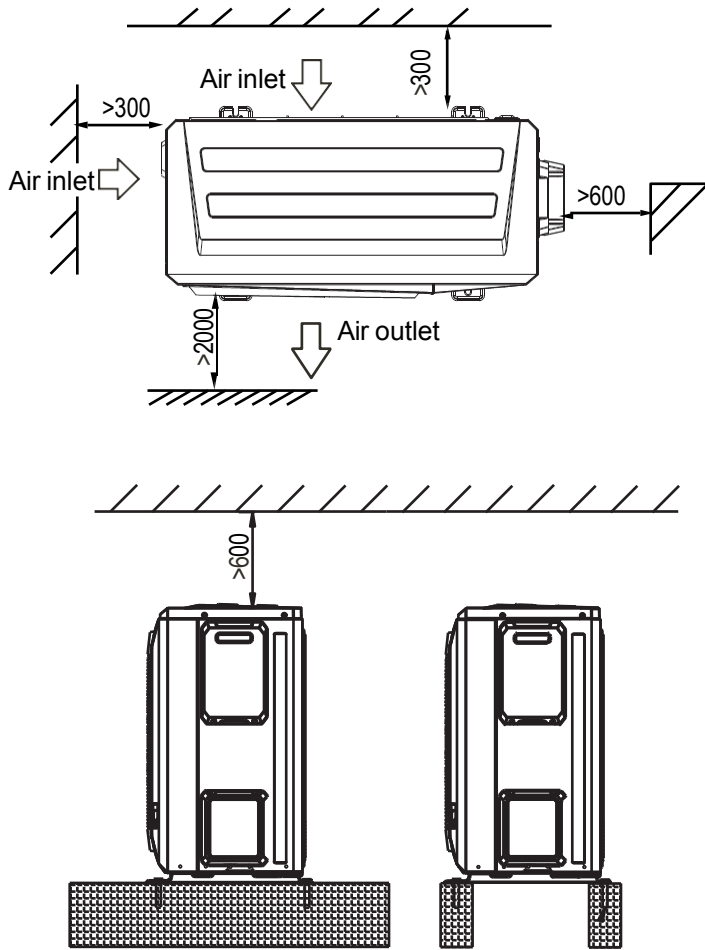

#### 3.2 Parallel connect the two units or above

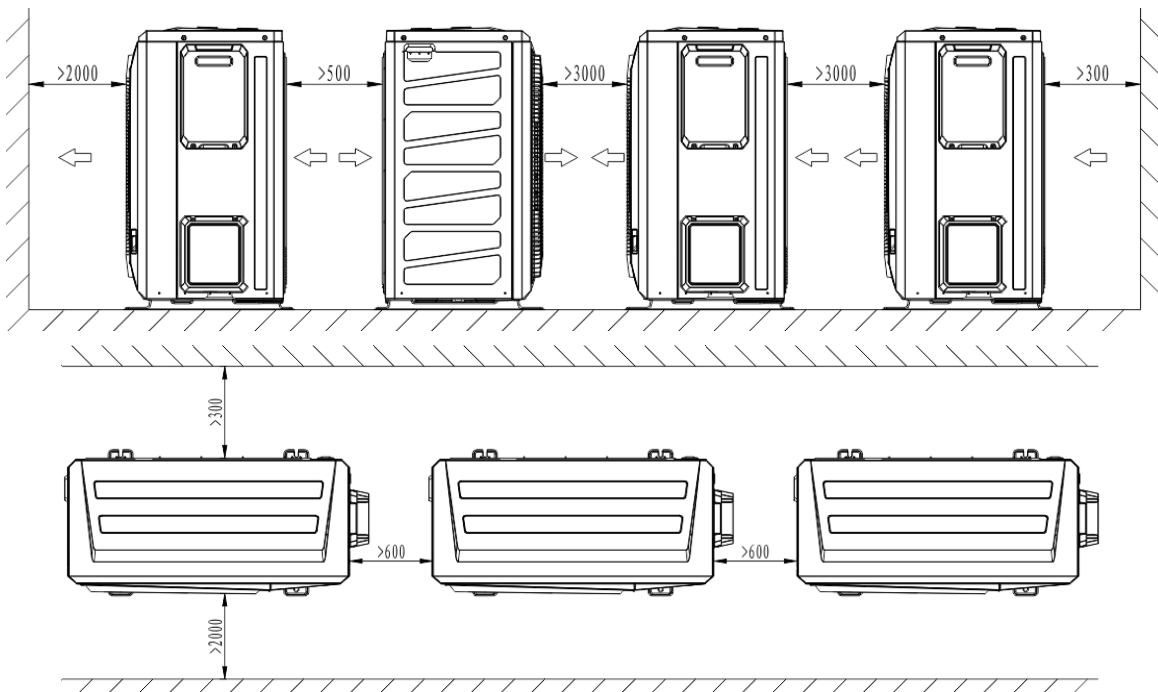

## 4. Piping Diagrams

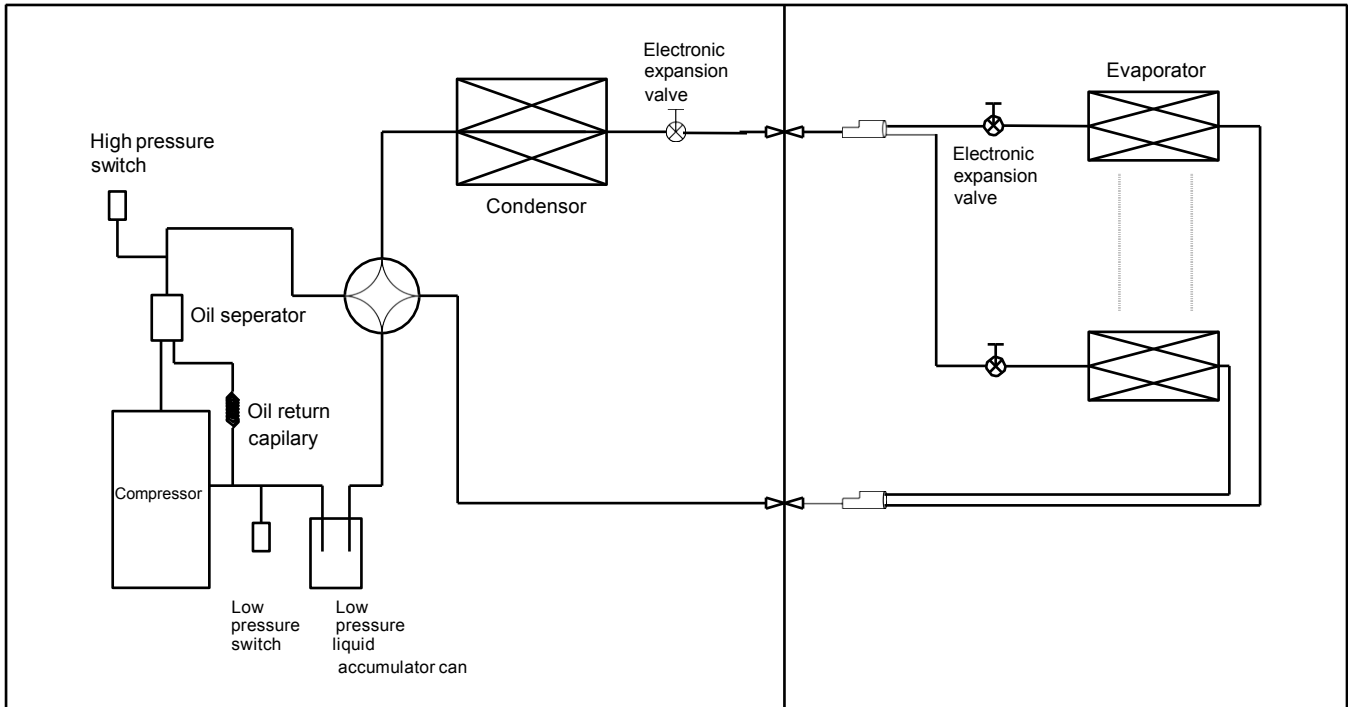

**Oil separator:** It is used to separate oil from high pressure & temperature gas refrigerant that is pumped out from compressor. The separation efficiency is up to 99%, it makes the oil return back to each compressor very soon.

**Gas-liquid separator:** It is used to store the liquid refrigerant and oil, it can protect the compressor from liquid hammer.

**4-way valve:** Closed in cooling mode and open in heating mode.

**Electronic expansion valve:** The opening of the valve is regulated according to the discharge air temperature of compressor, used to regulating refrigerant flow.

**High Pressure Switch:** When the discharge pressure of compressor is 4.5Mpa or higher, the protection switch will be triggered, and if the discharge pressure is down to 3.5MPa, the protection switch will be recovered.

**Low Pressure Switch:** When the gas pressure back to compressor is 0.05Mpa or lower, the protection switch will be triggered, and if the discharge pressure is down to 0.15MPa, the protection switch will be recovered.

# 5. Wiring Diagrams

## 5.1 For 8/10kW

### ELECTRICAL WIRING DIAGRAM

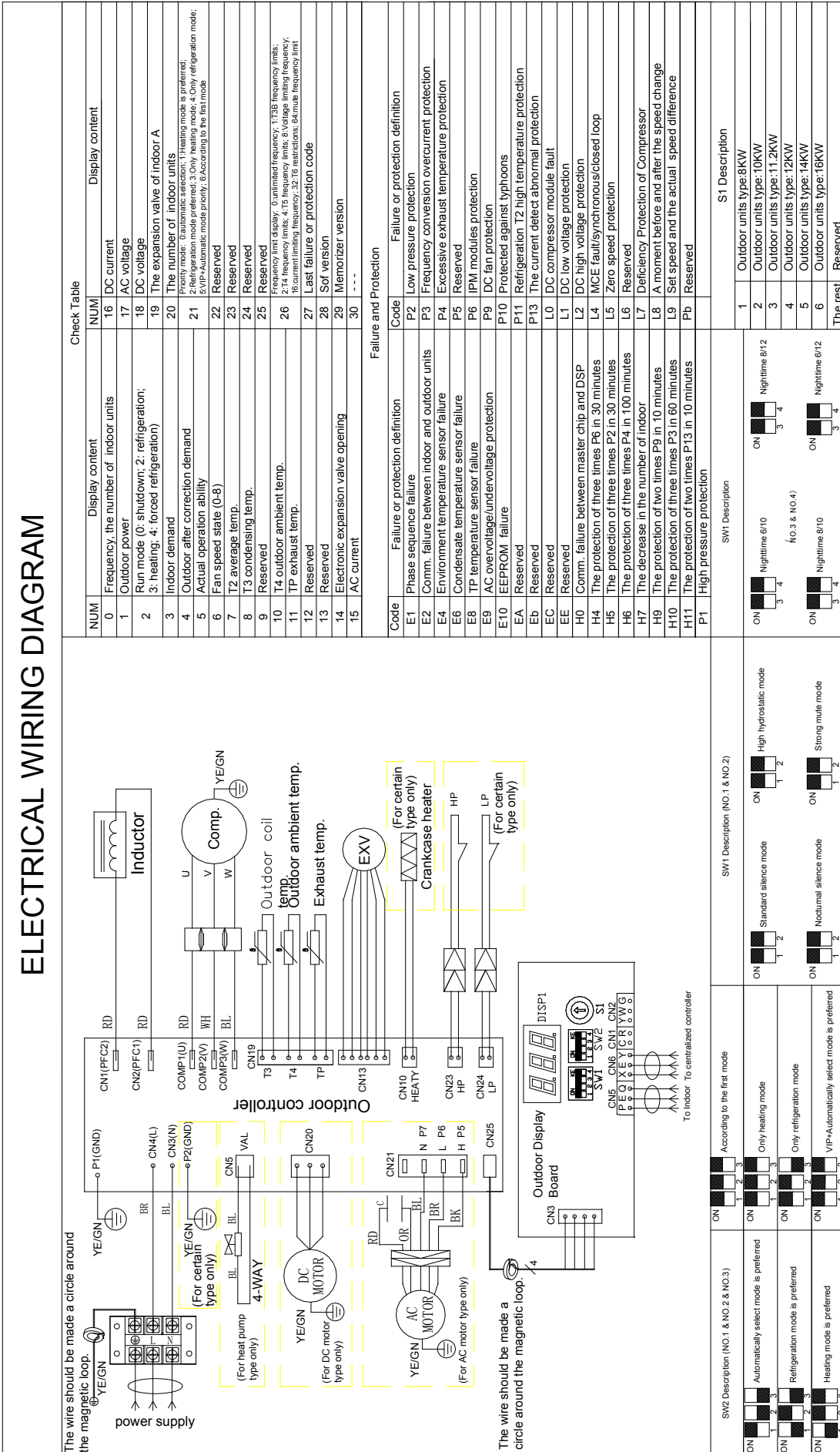

# VNMF Mini VRF 50/60Hz

## 5.2 For 12.5/14/16kW

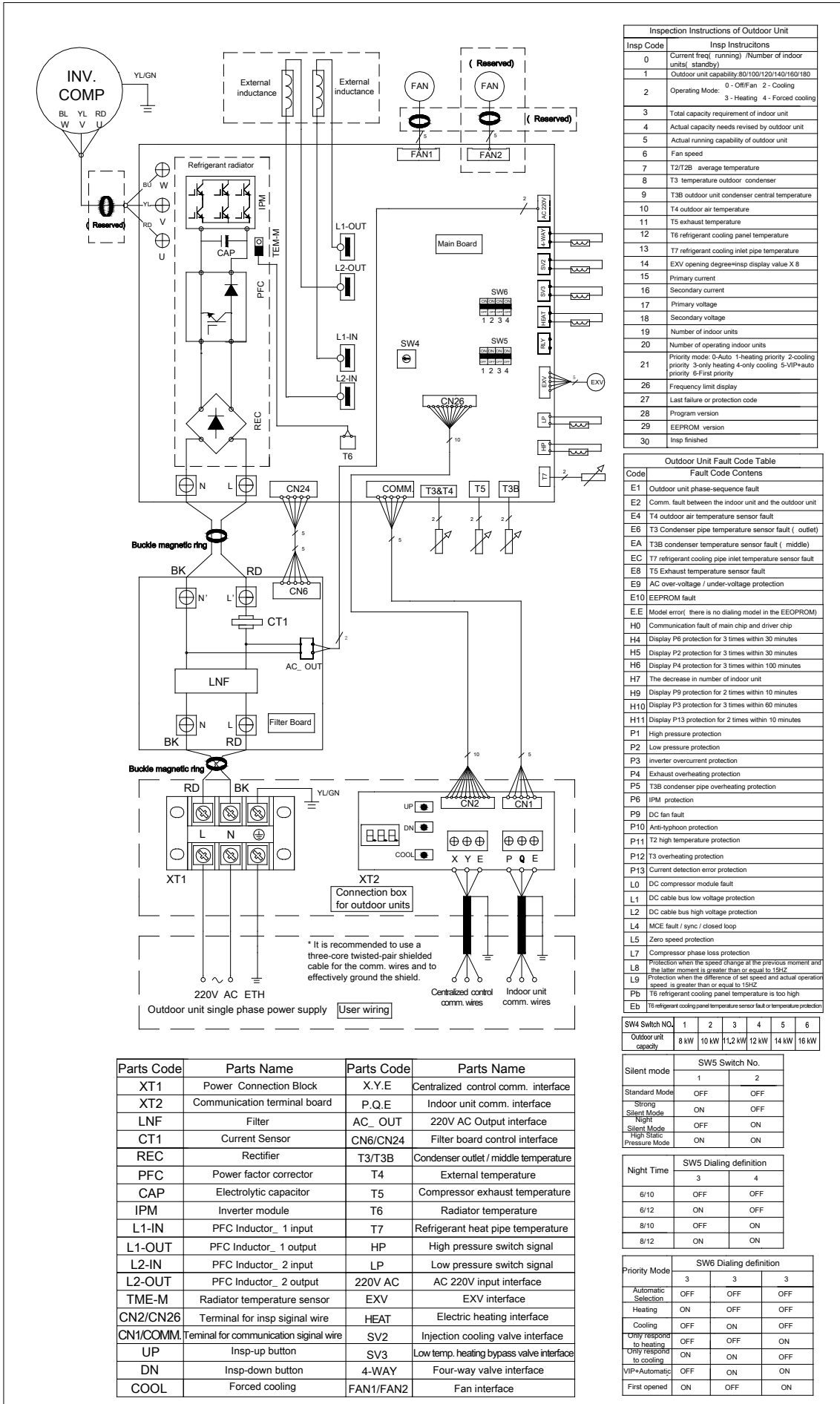

Parts Code	Parts Name	Parts Code	Parts Name
XT1	Power Connection Block	X.Y.E	Centralized control comm. interface
XT2	Communication terminal board	P.Q.E	Indoor unit comm. interface
LNF	Filter	AC_OUT	220V AC Output interface
CT1	Current Sensor	CN6/CN24	Filter board control interface
REC	Rectifier	T3/T3B	Condenser outlet / middle temperature
PFC	Power factor corrector	T4	External temperature
CAP	Electrolytic capacitor	T5	Compressor exhaust temperature
IPM	Inverter module	T6	Radiator temperature
L1-IN	PFC Inductor_1 input	T7	Refrigerant heat pipe temperature
L1-OUT	PFC Inductor_1 output	HP	High pressure switch signal
L2-IN	PFC Inductor_2 input	LP	Low pressure switch signal
L2-OUT	PFC Inductor_2 output	220V AC	AC 220V input interface
TME-M	Radiator temperature sensor	EXV	EXV interface
CN2/CN26	Terminal for insp signal wire	HEAT	Electric heating interface
CN1/COMM.	Terminal for communication signal wire	SV2	Injection cooling valve interface
UP	Insp-up button	SV3	Low temp. heating bypass valve interface
DN	Insp-down button	4-WAY	Four-way valve interface
COOL	Forced cooling	FAN1/FAN2	Fan interface

Inspection Instructions of Outdoor Unit	
Insp Code	Insp Instructions
0	Current freq( running) /Number of indoor units( standby)
1	Outdoor unit capacity: 80/100/120/140/160/180
2	Operating Mode: 0 - Off/Flag 2 - Cooling 3 - Heating 4 - Forced cooling
3	Total capacity requirement of indoor unit
4	Actual capacity needs revised by outdoor unit
5	Actual running capability of outdoor unit
6	Fan speed
7	T2/T2B average temperature
8	T3 temperature outdoor condenser
9	T3B outdoor unit condenser central temperature
10	T4 outdoor air temperature
11	T5 exhaust temperature
12	T6 refrigerant cooling panel temperature
13	T7 refrigerant cooling inlet pipe temperature
14	EXV opening degree=insp display value X 8
15	Primary current
16	Secondary current
17	Primary voltage
18	Secondary voltage
19	Number of indoor units
20	Number of operating indoor units
21	Priority mode: 0-Auto 1-heating priority 2-cooling priority 3-only heating 4-only cooling 5-VIP+auto priority 6-First priority
26	Frequency limit display
27	Last failure or protection code
28	Program version
29	EEPROM version
30	Insp finished

Outdoor Unit Fault Code Table	
Code	Fault Code Contents
E1	Outdoor unit phase-sequence fault
E2	Comm. fault between the indoor unit and the outdoor unit
E4	T4 outdoor air temperature sensor fault
E6	T3 Condenser pipe temperature sensor fault ( outlet)
EA	T3B condenser temperature sensor fault ( middle)
EC	T7 refrigerant cooling inlet pipe temperature sensor fault
E8	T5 Exhaust temperature sensor fault
E9	AC over-voltage / under-voltage protection
E10	EEPROM fault
E.E	Model error ( there is no dialing model in the EEPROM)
H0	Communication fault of main chip and driver chip
H4	Display P6 protection for 3 times within 30 minutes
H5	Display P2 protection for 3 times within 30 minutes
H6	Display P4 protection for 3 times within 100 minutes
H7	The decrease in number of indoor unit
H9	Display P9 protection for 2 times within 10 minutes
H10	Display P3 protection for 3 times within 60 minutes
H11	Display P13 protection for 2 times within 10 minutes
P1	High pressure protection
P2	Low pressure protection
P3	inverter overcurrent protection
P4	Exhaust overheating protection
P5	T3B condenser pipe overheating protection
P6	IPM protection
P9	DC fan fault
P10	Anti-typhoon protection
P11	T2 high temperature protection
P12	T3 overheating protection
P13	Current detection error protection
L0	DC compressor module fault
L1	DC cable bus low voltage protection
L2	DC cable bus high voltage protection
L4	MCE fault / sync / closed loop
L5	Zero speed protection
L7	Compressor phase loss protection
L8	Protection when the speed change at the previous moment and the latter moment is greater than or equal to 15Hz
L9	Protection when the difference of set speed and actual operation speed is greater than or equal to 15Hz
Pb	T6 refrigerant cooling panel temperature is too high
Eb	T6 refrigerant cooling panel temperature sensor fault or temperature protection

SW4 Switch NO.	1	2	3	4	5	6
Outdoor unit capacity	8 kW	10 kW	11,2 kW	12 kW	14 kW	16 kW

Silent mode	SW5 Switch No.	
	1	2
Standard Mode	OFF	OFF
Strong Silent Mode	ON	OFF
Night Silent Mode	OFF	ON
High Static Pressure Mode	ON	ON

Night Time	SW5 Dialing definition	
	3	4
6/10	OFF	OFF
6/12	ON	OFF
8/10	OFF	ON
8/12	ON	ON

Priority Mode	SW6 Dialing definition		
	3	3	3
Automatic Selection	OFF	OFF	OFF
Heating	ON	OFF	OFF
Cooling	OFF	ON	OFF
Only responds to heating	OFF	OFF	ON
Only responds to cooling	ON	ON	OFF
VIP+Automatic	OFF	ON	ON
First opened	ON	OFF	ON

### 6. Field Wiring

If needed, the user can purchase a centralized controller, as shown in the dashed box. For the specific method of installation, please contact your local supplier.

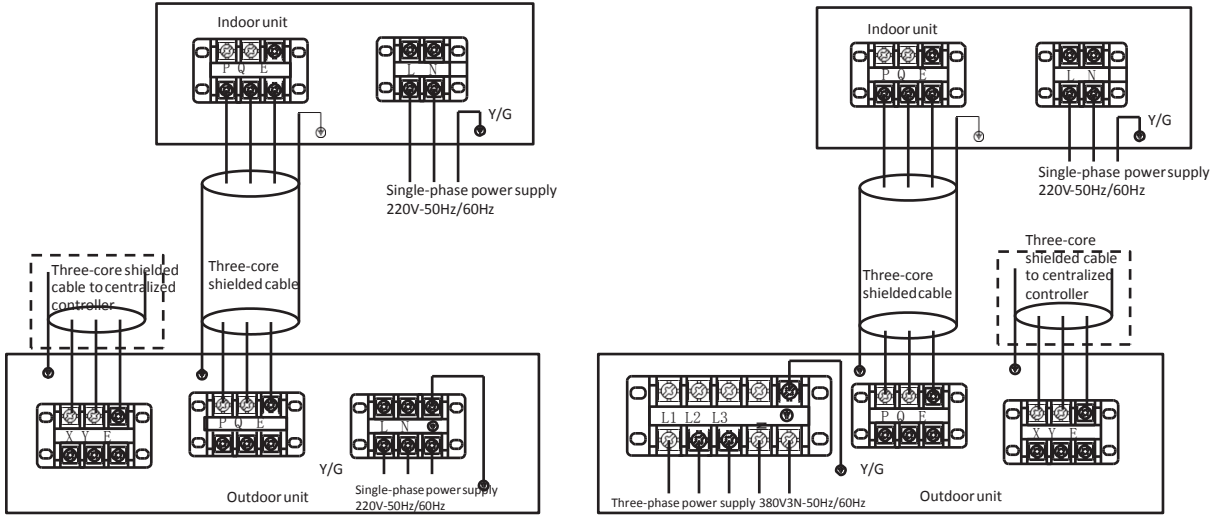
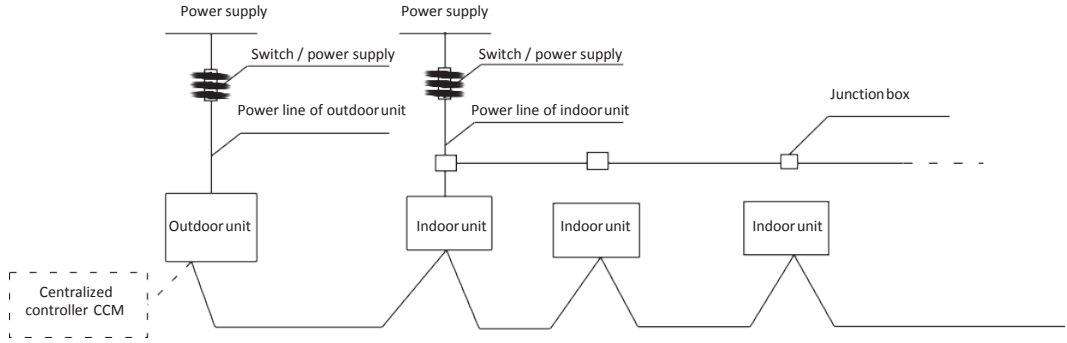

# VNMF Mini VRF 50/60Hz

## 7. Capacity Tables

### 7.1 Cooling

VNMF002Q0A-G04V080

TC: Total Capacity (kW); PI: Power Input (kW) (Compressor + Outdoor fan motor)

Combination (%) (Capacity index)	Outdoor Air temperature (° C DB)	Indoor temperature (° C WB)													
		DB: 20.8, WB: 14		DB: 23.3, WB: 16		DB: 25.8, WB: 18		DB: 27, WB: 19		DB: 28.2, WB: 20		DB: 30.7, WB: 22		DB: 32, WB: 24	
		TC kW	PI kW	TC kW	PI kW	TC kW	PI kW	TC kW	PI kW	TC kW	PI kW	TC kW	PI kW	TC kW	PI kW
130%	-5	5.6	1.01	6.0	1.06	6.1	1.10	6.3	1.12	6.4	1.14	6.6	1.18	6.8	1.21
	-2	5.5	1.02	5.8	1.07	6.0	1.11	6.1	1.13	6.3	1.15	6.5	1.19	6.6	1.22
	0	5.4	1.03	5.7	1.09	5.9	1.12	6.0	1.14	6.1	1.17	6.3	1.20	6.5	1.23
	2	5.3	1.04	5.6	1.10	5.8	1.13	5.9	1.15	6.0	1.18	6.2	1.21	6.4	1.25
	4	5.2	1.05	5.5	1.11	5.7	1.14	5.8	1.17	5.9	1.19	6.1	1.22	6.3	1.26
	6	5.1	1.06	5.4	1.12	5.6	1.15	5.7	1.18	5.8	1.20	6.0	1.24	6.1	1.27
	8	5.0	1.07	5.3	1.13	5.5	1.17	5.6	1.19	5.7	1.21	5.8	1.25	6.0	1.28
	10	6.7	1.42	7.1	1.50	7.3	1.55	7.4	1.58	7.6	1.61	7.8	1.66	8.0	1.71
	12	6.6	1.48	6.9	1.56	7.2	1.61	7.3	1.64	7.4	1.68	7.7	1.73	7.9	1.78
	14	6.4	1.54	6.8	1.63	7.0	1.68	7.2	1.71	7.3	1.75	7.5	1.80	7.7	1.85
	16	6.3	1.61	6.7	1.70	6.9	1.75	7.0	1.78	7.2	1.82	7.4	1.87	7.6	1.93
	18	7.3	1.80	7.7	1.90	8.0	1.96	8.2	2.00	8.3	2.04	8.6	2.10	8.8	2.16
	20	7.2	1.82	7.6	1.92	7.8	1.98	8.0	2.02	8.2	2.06	8.4	2.12	8.6	2.18
	21	7.1	1.84	7.4	1.94	7.7	2.00	7.8	2.04	8.0	2.08	8.2	2.14	8.5	2.20
	23	6.9	1.86	7.3	1.96	7.5	2.02	7.7	2.06	7.8	2.10	8.1	2.16	8.3	2.23
	25	6.8	1.87	7.2	1.98	7.4	2.04	7.5	2.08	7.7	2.12	7.9	2.19	8.1	2.25
	27	8.3	2.34	8.8	2.47	9.1	2.55	9.3	2.60	9.5	2.65	9.7	2.73	10.0	2.81
	29	8.2	2.36	8.6	2.49	8.9	2.57	9.1	2.62	9.3	2.68	9.5	2.75	9.8	2.83
	31	8.0	2.39	8.5	2.52	8.7	2.60	8.9	2.65	9.1	2.70	9.4	2.78	9.6	2.86
	33	7.9	2.41	8.3	2.54	8.6	2.62	8.7	2.68	8.9	2.73	9.2	2.81	9.4	2.89
	35	7.7	2.43	8.1	2.57	8.4	2.65	8.6	2.70	8.7	2.76	9.0	2.84	9.2	2.92
	37	7.5	2.45	8.0	2.58	8.2	2.66	8.4	2.72	8.6	2.77	8.8	2.85	9.1	2.93
39	7.2	2.40	7.6	2.53	7.8	2.61	8.0	2.66	8.1	2.72	8.4	2.80	8.6	2.88	
41	6.8	2.35	7.2	2.48	7.4	2.56	7.6	2.61	7.7	2.66	7.9	2.74	8.2	2.82	
43	6.5	2.30	6.8	2.43	7.0	2.51	7.2	2.56	7.3	2.61	7.6	2.69	7.8	2.76	
45	6.1	2.23	6.5	2.36	6.7	2.43	6.8	2.48	7.0	2.53	7.2	2.61	7.4	2.68	
48	5.8	2.12	6.2	2.24	6.4	2.31	6.5	2.36	6.6	2.40	6.8	2.47	7.0	2.55	
50	5.5	1.95	5.9	2.06	6.0	2.13	6.2	2.17	6.3	2.21	6.5	2.28	6.7	2.34	
52	5.3	1.80	5.6	1.90	5.7	1.96	5.9	1.99	6.0	2.03	6.2	2.09	6.3	2.15	
55	5.0	1.65	5.3	1.74	5.5	1.80	5.6	1.84	5.7	1.87	5.8	1.93	6.0	1.98	
120%	-5	5.5	1.00	5.8	1.05	6.0	1.09	6.1	1.11	6.3	1.13	6.5	1.16	6.6	1.20
	-2	5.4	1.01	5.7	1.06	5.9	1.10	6.0	1.12	6.1	1.14	6.3	1.18	6.5	1.21
	0	5.3	1.02	5.6	1.08	5.8	1.11	5.9	1.13	6.0	1.15	6.2	1.19	6.4	1.22
	2	5.2	1.03	5.5	1.09	5.7	1.12	5.8	1.14	5.9	1.17	6.1	1.20	6.3	1.23
	4	5.1	1.04	5.4	1.10	5.6	1.13	5.7	1.15	5.8	1.18	6.0	1.21	6.1	1.25
	6	5.0	1.05	5.3	1.11	5.5	1.14	5.6	1.17	5.7	1.19	5.8	1.22	6.0	1.26
	8	4.9	1.06	5.2	1.12	5.4	1.15	5.5	1.18	5.6	1.20	5.7	1.24	5.9	1.27
	10	6.6	1.41	6.9	1.49	7.2	1.53	7.3	1.56	7.5	1.60	7.7	1.64	7.9	1.69
	12	6.4	1.47	6.8	1.55	7.0	1.60	7.2	1.63	7.3	1.66	7.5	1.71	7.7	1.76
	14	6.3	1.53	6.7	1.61	6.9	1.66	7.0	1.70	7.2	1.73	7.4	1.78	7.6	1.83
	16	6.2	1.59	6.5	1.68	6.8	1.73	6.9	1.77	7.0	1.80	7.2	1.86	7.4	1.91
	18	7.2	1.78	7.6	1.88	7.8	1.94	8.0	1.98	8.2	2.02	8.4	2.08	8.6	2.14
	20	7.1	1.80	7.5	1.90	7.7	1.96	7.8	2.00	8.0	2.04	8.2	2.10	8.5	2.16
	21	6.9	1.82	7.3	1.92	7.5	1.98	7.7	2.02	7.8	2.06	8.1	2.12	8.3	2.18
	23	6.8	1.84	7.2	1.94	7.4	2.00	7.5	2.04	7.7	2.08	7.9	2.14	8.1	2.20
	25	6.7	1.86	7.0	1.96	7.2	2.02	7.4	2.06	7.5	2.10	7.8	2.17	8.0	2.23
	27	8.2	2.32	8.6	2.44	8.9	2.52	9.1	2.57	9.3	2.62	9.5	2.70	9.8	2.78
	29	8.0	2.34	8.5	2.47	8.7	2.55	8.9	2.60	9.1	2.65	9.4	2.73	9.6	2.81
	31	7.9	2.36	8.3	2.49	8.6	2.57	8.7	2.62	8.9	2.68	9.2	2.76	9.4	2.83
	33	7.7	2.39	8.1	2.52	8.4	2.60	8.6	2.65	8.7	2.70	9.0	2.78	9.3	2.86
	35	7.6	2.41	8.0	2.54	8.2	2.62	8.4	2.68	8.6	2.73	8.8	2.81	9.1	2.89
	37	7.4	2.42	7.8	2.56	8.1	2.64	8.2	2.69	8.4	2.75	8.6	2.83	8.9	2.91
39	7.0	2.37	7.4	2.51	7.7	2.58	7.8	2.64	8.0	2.69	8.2	2.77	8.4	2.85	
41	6.7	2.33	7.1	2.46	7.3	2.53	7.4	2.58	7.6	2.64	7.8	2.71	8.0	2.79	
43	6.4	2.28	6.7	2.41	6.9	2.48	7.1	2.53	7.2	2.58	7.4	2.66	7.6	2.74	
45	6.0	2.21	6.4	2.33	6.6	2.41	6.7	2.46	6.8	2.51	7.0	2.58	7.2	2.65	
48	5.7	2.10	6.1	2.22	6.2	2.29	6.4	2.33	6.5	2.38	6.7	2.45	6.9	2.52	
50	5.4	1.93	5.7	2.04	5.9	2.10	6.1	2.15	6.2	2.19	6.4	2.25	6.5	2.32	
52	5.2	1.78	5.5	1.88	5.6	1.94	5.7	1.98	5.9	2.02	6.0	2.07	6.2	2.13	
55	4.9	1.64	5.2	1.73	5.4	1.78	5.5	1.82	5.6	1.85	5.7	1.91	5.9	1.96	



Combination (%) (Capacity index)	Outdoor Air temperature (° C DB)	Indoor temperature (° C WB)													
		DB: 20.8, WB: 14		DB: 23.3, WB: 16		DB: 25.8, WB: 18		DB: 27, WB: 19		DB: 28.2, WB: 20		DB: 30.7, WB: 22		DB: 32, WB: 24	
		TC	PI	TC	PI	TC	PI	TC	PI	TC	PI	TC	PI	TC	PI
		kW	kW	kW	kW	kW	kW	kW	kW	kW	kW	kW	kW	kW	kW
110%	-5	5.4	0.99	5.7	1.04	5.9	1.08	6.0	1.10	6.2	1.12	6.3	1.15	6.5	1.19
	-2	5.3	1.00	5.6	1.05	5.8	1.09	5.9	1.11	6.0	1.13	6.2	1.17	6.4	1.20
	0	5.2	1.01	5.5	1.06	5.7	1.10	5.8	1.12	5.9	1.14	6.1	1.18	6.3	1.21
	2	5.1	1.02	5.4	1.08	5.6	1.11	5.7	1.13	5.8	1.15	6.0	1.19	6.1	1.22
	4	5.0	1.03	5.3	1.09	5.5	1.12	5.6	1.14	5.7	1.17	5.9	1.20	6.0	1.24
	6	4.9	1.04	5.2	1.10	5.4	1.13	5.5	1.16	5.6	1.18	5.7	1.21	5.9	1.25
	8	4.8	1.05	5.1	1.11	5.2	1.14	5.4	1.17	5.5	1.19	5.6	1.23	5.8	1.26
	10	6.5	1.39	6.8	1.47	7.0	1.52	7.2	1.55	7.3	1.58	7.5	1.63	7.7	1.67
	12	6.3	1.45	6.7	1.53	6.9	1.58	7.0	1.61	7.2	1.65	7.4	1.69	7.6	1.74
	14	6.2	1.51	6.5	1.60	6.8	1.65	6.9	1.68	7.0	1.71	7.2	1.76	7.4	1.81
	16	6.1	1.58	6.4	1.66	6.6	1.72	6.8	1.75	6.9	1.79	7.1	1.84	7.3	1.89
	18	7.1	1.77	7.5	1.86	7.7	1.92	7.8	1.96	8.0	2.00	8.2	2.06	8.5	2.12
	20	6.9	1.78	7.3	1.88	7.5	1.94	7.7	1.98	7.8	2.02	8.1	2.08	8.3	2.14
	21	6.8	1.80	7.2	1.90	7.4	1.96	7.5	2.00	7.7	2.04	7.9	2.10	8.1	2.16
	23	6.7	1.82	7.0	1.92	7.2	1.98	7.4	2.02	7.5	2.06	7.8	2.12	8.0	2.18
	25	6.5	1.84	6.9	1.94	7.1	2.00	7.3	2.04	7.4	2.08	7.6	2.14	7.8	2.21
	27	8.0	2.29	8.5	2.42	8.7	2.50	8.9	2.55	9.1	2.60	9.4	2.67	9.6	2.75
	29	7.9	2.32	8.3	2.44	8.6	2.52	8.7	2.57	8.9	2.62	9.2	2.70	9.4	2.78
	31	7.7	2.34	8.1	2.47	8.4	2.55	8.6	2.60	8.7	2.65	9.0	2.73	9.3	2.81
	33	7.6	2.36	8.0	2.49	8.2	2.57	8.4	2.63	8.6	2.68	8.8	2.76	9.1	2.84
	35	7.4	2.39	7.8	2.52	8.1	2.60	8.2	2.65	8.4	2.71	8.7	2.78	8.9	2.86
	37	7.3	2.40	7.7	2.53	7.9	2.61	8.1	2.67	8.2	2.72	8.5	2.80	8.7	2.88
	39	6.9	2.35	7.3	2.48	7.5	2.56	7.7	2.61	7.8	2.66	8.1	2.74	8.3	2.82
	41	6.6	2.30	6.9	2.43	7.1	2.51	7.3	2.56	7.4	2.61	7.7	2.69	7.9	2.76
	43	6.2	2.26	6.6	2.38	6.8	2.46	6.9	2.51	7.1	2.56	7.3	2.63	7.5	2.71
45	5.9	2.19	6.2	2.31	6.4	2.38	6.6	2.43	6.7	2.48	6.9	2.55	7.1	2.63	
48	5.6	2.08	5.9	2.20	6.1	2.27	6.2	2.31	6.4	2.36	6.6	2.43	6.7	2.50	
50	5.3	1.91	5.6	2.02	5.8	2.08	5.9	2.13	6.1	2.17	6.2	2.23	6.4	2.30	
52	5.1	1.76	5.4	1.86	5.5	1.92	5.6	1.96	5.8	2.00	5.9	2.05	6.1	2.11	
55	4.8	1.62	5.1	1.71	5.3	1.76	5.4	1.80	5.5	1.84	5.6	1.89	5.8	1.94	
100%	-5	5.3	0.97	5.6	1.02	5.7	1.06	5.9	1.08	6.0	1.10	6.1	1.13	6.3	1.16
	-2	5.2	0.98	5.5	1.03	5.6	1.07	5.7	1.09	5.9	1.11	6.0	1.14	6.2	1.17
	0	5.1	0.99	5.3	1.04	5.5	1.08	5.6	1.10	5.7	1.12	5.9	1.15	6.1	1.19
	2	5.0	1.00	5.2	1.05	5.4	1.09	5.5	1.11	5.6	1.13	5.8	1.17	6.0	1.20
	4	4.9	1.01	5.1	1.07	5.3	1.10	5.4	1.12	5.5	1.14	5.7	1.18	5.8	1.21
	6	4.8	1.02	5.0	1.08	5.2	1.11	5.3	1.13	5.4	1.16	5.6	1.19	5.7	1.22
	8	4.7	1.03	4.9	1.09	5.1	1.12	5.2	1.14	5.3	1.17	5.5	1.20	5.6	1.24
	10	6.3	1.37	6.6	1.44	6.8	1.49	7.0	1.52	7.1	1.55	7.3	1.59	7.5	1.64
	12	6.1	1.42	6.5	1.50	6.7	1.55	6.8	1.58	7.0	1.61	7.2	1.66	7.4	1.71
	14	6.0	1.48	6.4	1.56	6.6	1.61	6.7	1.65	6.8	1.68	7.0	1.73	7.2	1.78
	16	5.9	1.54	6.2	1.63	6.4	1.68	6.6	1.72	6.7	1.75	6.9	1.80	7.1	1.85
	18	6.9	1.73	7.2	1.83	7.5	1.88	7.6	1.92	7.8	1.96	8.0	2.02	8.2	2.08
	20	6.7	1.75	7.1	1.85	7.3	1.90	7.5	1.94	7.6	1.98	7.8	2.04	8.1	2.10
	21	6.6	1.77	7.0	1.86	7.2	1.92	7.3	1.96	7.5	2.00	7.7	2.06	7.9	2.12
	23	6.5	1.78	6.8	1.88	7.0	1.94	7.2	1.98	7.3	2.02	7.5	2.08	7.8	2.14
	25	6.3	1.80	6.7	1.90	6.9	1.96	7.0	2.00	7.2	2.04	7.4	2.10	7.6	2.16
	27	7.8	2.25	8.2	2.37	8.5	2.45	8.7	2.50	8.8	2.55	9.1	2.62	9.4	2.70
	29	7.6	2.27	8.1	2.40	8.3	2.47	8.5	2.52	8.7	2.57	8.9	2.65	9.2	2.72
	31	7.5	2.29	7.9	2.42	8.2	2.50	8.3	2.55	8.5	2.60	8.7	2.68	9.0	2.75
	33	7.3	2.32	7.8	2.45	8.0	2.52	8.2	2.57	8.3	2.63	8.6	2.70	8.8	2.78
	35	7.2	2.34	7.6	2.47	7.8	2.55	8.0	2.60	8.2	2.65	8.4	2.73	8.6	2.81
	37	7.1	2.35	7.4	2.48	7.7	2.56	7.8	2.64	8.0	2.67	8.2	2.74	8.5	2.82
	39	6.7	2.30	7.1	2.43	7.3	2.51	7.7	2.68	7.6	2.61	7.8	2.69	8.0	2.77
	41	6.4	2.26	6.7	2.38	6.9	2.46	7.5	2.73	7.2	2.56	7.4	2.64	7.6	2.71
	43	6.0	2.21	6.4	2.34	6.6	2.41	7.4	2.77	6.9	2.51	7.1	2.58	7.3	2.66
45	5.7	2.15	6.1	2.27	6.3	2.34	7.2	2.81	6.5	2.43	6.7	2.50	6.9	2.58	
48	5.5	2.04	5.8	2.15	5.9	2.22	7.1	2.86	6.2	2.31	6.4	2.38	6.6	2.45	
50	5.2	1.88	5.5	1.98	5.6	2.04	6.9	2.91	5.9	2.13	6.1	2.19	6.2	2.25	
52	4.9	1.73	5.2	1.82	5.4	1.88	6.8	2.95	5.6	1.96	5.7	2.01	5.9	2.07	
55	4.7	1.59	4.9	1.68	5.1	1.73	6.7	3.00	5.3	1.80	5.5	1.85	5.6	1.91	

# VNMF Mini VRF 50/60Hz

Combination (%) (Capacity index)	Outdoor Air temperature (° C DB)	Indoor temperature (° C WB)													
		DB: 20.8, WB: 14		DB: 23.3, WB: 16		DB: 25.8, WB: 18		DB: 27, WB: 19		DB: 28.2, WB: 20		DB: 30.7, WB: 22		DB: 32, WB: 24	
		TC	PI	TC	PI	TC	PI	TC	PI	TC	PI	TC	PI	TC	PI
		kW	kW	kW	kW	kW	kW	kW	kW	kW	kW	kW	kW	kW	kW
90%	-5	5.0	0.91	5.3	0.96	5.5	0.99	5.6	1.01	5.7	1.03	5.8	1.06	6.0	1.09
	-2	4.9	0.92	5.2	0.97	5.3	1.00	5.5	1.02	5.6	1.04	5.7	1.07	5.9	1.10
	0	4.8	0.93	5.1	0.98	5.2	1.01	5.3	1.03	5.5	1.05	5.6	1.08	5.8	1.12
	2	4.7	0.94	5.0	0.99	5.1	1.02	5.2	1.04	5.3	1.06	5.5	1.10	5.7	1.13
	4	4.6	0.95	4.9	1.00	5.0	1.03	5.1	1.05	5.2	1.08	5.4	1.11	5.6	1.14
	6	4.5	0.96	4.8	1.01	4.9	1.04	5.0	1.06	5.1	1.09	5.3	1.12	5.4	1.15
	8	4.4	0.97	4.7	1.02	4.8	1.05	4.9	1.08	5.0	1.10	5.2	1.13	5.3	1.16
	10	6.0	1.28	6.3	1.36	6.5	1.40	6.6	1.43	6.7	1.46	6.9	1.50	7.1	1.54
	12	5.8	1.34	6.2	1.41	6.4	1.46	6.5	1.49	6.6	1.52	6.8	1.56	7.0	1.61
	14	5.7	1.39	6.0	1.47	6.2	1.52	6.4	1.55	6.5	1.58	6.7	1.63	6.9	1.67
	16	5.6	1.45	5.9	1.53	6.1	1.58	6.2	1.61	6.4	1.65	6.5	1.69	6.7	1.74
	18	6.5	1.63	6.9	1.72	7.1	1.77	7.2	1.81	7.4	1.84	7.6	1.90	7.8	1.95
	20	6.4	1.64	6.7	1.73	7.0	1.79	7.1	1.83	7.2	1.86	7.5	1.92	7.7	1.97
	21	6.3	1.66	6.6	1.75	6.8	1.81	7.0	1.84	7.1	1.88	7.3	1.94	7.5	1.99
	23	6.1	1.68	6.5	1.77	6.7	1.83	6.8	1.86	7.0	1.90	7.2	1.96	7.4	2.01
	25	6.0	1.69	6.4	1.79	6.6	1.84	6.7	1.88	6.8	1.92	7.0	1.98	7.2	2.03
	27	7.4	2.11	7.8	2.23	8.1	2.30	8.2	2.35	8.4	2.39	8.6	2.47	8.9	2.54
	29	7.3	2.13	7.7	2.25	7.9	2.32	8.1	2.37	8.2	2.42	8.5	2.49	8.7	2.56
	31	7.1	2.16	7.5	2.28	7.7	2.35	7.9	2.40	8.1	2.44	8.3	2.52	8.5	2.59
	33	7.0	2.18	7.4	2.30	7.6	2.37	7.8	2.42	7.9	2.47	8.1	2.54	8.4	2.61
35	6.8	2.20	7.2	2.32	7.4	2.40	7.6	2.44	7.8	2.49	8.0	2.57	8.2	2.64	
37	6.7	2.21	7.1	2.33	7.3	2.41	7.4	2.46	7.6	2.51	7.8	2.58	8.0	2.65	
39	6.4	2.17	6.7	2.29	6.9	2.36	7.1	2.41	7.2	2.46	7.4	2.53	7.6	2.60	
41	6.0	2.12	6.4	2.24	6.6	2.31	6.7	2.36	6.9	2.41	7.1	2.48	7.3	2.55	
43	5.7	2.08	6.1	2.20	6.3	2.27	6.4	2.31	6.5	2.36	6.7	2.43	6.9	2.50	
45	5.5	2.02	5.8	2.13	5.9	2.20	6.1	2.24	6.2	2.29	6.4	2.35	6.6	2.42	
48	5.2	1.92	5.5	2.02	5.6	2.09	5.8	2.13	5.9	2.17	6.1	2.24	6.2	2.30	
50	4.9	1.76	5.2	1.86	5.4	1.92	5.5	1.96	5.6	2.00	5.7	2.06	5.9	2.12	
52	4.7	1.62	4.9	1.71	5.1	1.77	5.2	1.80	5.3	1.84	5.5	1.89	5.6	1.95	
55	4.4	1.49	4.7	1.58	4.8	1.63	4.9	1.66	5.0	1.69	5.2	1.74	5.3	1.79	
80%	-5	4.5	0.82	4.8	0.87	4.9	0.90	5.0	0.92	5.1	0.93	5.3	0.96	5.4	0.99
	-2	4.4	0.83	4.7	0.88	4.8	0.91	4.9	0.92	5.0	0.94	5.2	0.97	5.3	1.00
	0	4.4	0.84	4.6	0.89	4.7	0.92	4.8	0.93	4.9	0.95	5.1	0.98	5.2	1.01
	2	4.3	0.85	4.5	0.90	4.7	0.92	4.7	0.94	4.8	0.96	5.0	0.99	5.1	1.02
	4	4.2	0.86	4.4	0.91	4.6	0.93	4.7	0.95	4.7	0.97	4.9	1.00	5.0	1.03
	6	4.1	0.87	4.3	0.91	4.5	0.94	4.6	0.96	4.7	0.98	4.8	1.01	4.9	1.04
	8	4.0	0.88	4.2	0.92	4.4	0.95	4.5	0.97	4.6	0.99	4.7	1.02	4.8	1.05
	10	5.4	1.16	5.7	1.23	5.9	1.26	6.0	1.29	6.1	1.32	6.3	1.35	6.5	1.39
	12	5.3	1.21	5.6	1.28	5.8	1.32	5.9	1.34	6.0	1.37	6.2	1.41	6.3	1.45
	14	5.2	1.26	5.5	1.33	5.6	1.37	5.8	1.40	5.9	1.43	6.0	1.47	6.2	1.51
	16	5.1	1.31	5.4	1.39	5.5	1.43	5.6	1.46	5.8	1.49	5.9	1.53	6.1	1.58
	18	5.9	1.47	6.2	1.55	6.4	1.60	6.6	1.63	6.7	1.67	6.9	1.72	7.1	1.77
	20	5.8	1.49	6.1	1.57	6.3	1.62	6.4	1.65	6.6	1.68	6.7	1.73	6.9	1.78
	21	5.7	1.50	6.0	1.58	6.2	1.63	6.3	1.67	6.4	1.70	6.6	1.75	6.8	1.80
	23	5.6	1.52	5.9	1.60	6.1	1.65	6.2	1.68	6.3	1.72	6.5	1.77	6.7	1.82
	25	5.4	1.53	5.8	1.62	5.9	1.67	6.1	1.70	6.2	1.74	6.4	1.79	6.5	1.84
	27	6.7	1.91	7.1	2.02	7.3	2.08	7.4	2.12	7.6	2.17	7.8	2.23	8.0	2.29
	29	6.6	1.93	6.9	2.04	7.2	2.10	7.3	2.14	7.4	2.19	7.7	2.25	7.9	2.32
	31	6.4	1.95	6.8	2.06	7.0	2.12	7.2	2.17	7.3	2.21	7.5	2.27	7.7	2.34
	33	6.3	1.97	6.7	2.08	6.9	2.14	7.0	2.19	7.2	2.23	7.4	2.30	7.6	2.36
35	6.2	1.99	6.5	2.10	6.7	2.17	6.9	2.21	7.0	2.25	7.2	2.32	7.4	2.39	
37	6.1	2.00	6.4	2.11	6.6	2.18	6.7	2.22	6.9	2.27	7.1	2.33	7.3	2.40	
39	5.8	1.96	6.1	2.07	6.3	2.13	6.4	2.18	6.5	2.22	6.7	2.29	6.9	2.35	
41	5.5	1.92	5.8	2.03	6.0	2.09	6.1	2.13	6.2	2.18	6.4	2.24	6.6	2.30	
43	5.2	1.88	5.5	1.99	5.7	2.05	5.8	2.09	5.9	2.13	6.1	2.19	6.2	2.26	
45	4.9	1.82	5.2	1.93	5.4	1.99	5.5	2.03	5.6	2.07	5.8	2.13	5.9	2.19	
48	4.7	1.73	5.0	1.83	5.1	1.89	5.2	1.93	5.3	1.96	5.5	2.02	5.6	2.08	
50	4.5	1.60	4.7	1.68	4.9	1.74	5.0	1.77	5.1	1.81	5.2	1.86	5.4	1.91	
52	4.2	1.47	4.5	1.55	4.6	1.60	4.7	1.63	4.8	1.66	4.9	1.71	5.1	1.76	
55	4.0	1.35	4.2	1.43	4.4	1.47	4.5	1.50	4.6	1.53	4.7	1.58	4.8	1.62	

Combination (%) (Capacity index)	Outdoor Air temperature (° C DB)	Indoor temperature (° C WB)													
		DB: 20.8, WB: 14		DB: 23.3, WB: 16		DB: 25.8, WB: 18		DB: 27, WB: 19		DB: 28.2, WB: 20		DB: 30.7, WB: 22		DB: 32, WB: 24	
		TC	PI	TC	PI	TC	PI	TC	PI	TC	PI	TC	PI	TC	PI
		kW	kW	kW	kW	kW	kW	kW	kW	kW	kW	kW	kW	kW	kW
70%	-5	4.1	0.74	4.3	0.78	4.4	0.80	4.5	0.82	4.6	0.83	4.7	0.86	4.9	0.88
	-2	4.0	0.74	4.2	0.79	4.3	0.81	4.4	0.83	4.5	0.84	4.6	0.87	4.8	0.89
	0	3.9	0.75	4.1	0.79	4.2	0.82	4.3	0.84	4.4	0.85	4.6	0.88	4.7	0.90
	2	3.8	0.76	4.0	0.80	4.2	0.83	4.2	0.84	4.3	0.86	4.5	0.89	4.6	0.91
	4	3.7	0.77	4.0	0.81	4.1	0.84	4.2	0.85	4.2	0.87	4.4	0.89	4.5	0.92
	6	3.7	0.77	3.9	0.82	4.0	0.84	4.1	0.86	4.2	0.88	4.3	0.90	4.4	0.93
	8	3.6	0.78	3.8	0.83	3.9	0.85	4.0	0.87	4.1	0.89	4.2	0.91	4.3	0.94
	10	4.8	1.04	5.1	1.10	5.3	1.13	5.4	1.15	5.5	1.18	5.6	1.21	5.8	1.25
	12	4.7	1.08	5.0	1.14	5.2	1.18	5.3	1.20	5.4	1.23	5.5	1.26	5.7	1.30
	14	4.6	1.13	4.9	1.19	5.0	1.23	5.2	1.25	5.3	1.28	5.4	1.31	5.6	1.35
	16	4.5	1.17	4.8	1.24	5.0	1.28	5.1	1.30	5.2	1.33	5.3	1.37	5.5	1.41
	18	5.3	1.32	5.6	1.39	5.8	1.43	5.9	1.46	6.0	1.49	6.2	1.53	6.3	1.58
	20	5.2	1.33	5.5	1.40	5.6	1.45	5.8	1.48	5.9	1.51	6.0	1.55	6.2	1.59
	21	5.1	1.34	5.4	1.42	5.5	1.46	5.6	1.49	5.8	1.52	5.9	1.57	6.1	1.61
	23	5.0	1.36	5.3	1.43	5.4	1.48	5.5	1.51	5.6	1.54	5.8	1.58	6.0	1.63
	25	4.9	1.37	5.1	1.45	5.3	1.49	5.4	1.52	5.5	1.55	5.7	1.60	5.9	1.64
	27	6.0	1.71	6.3	1.80	6.5	1.86	6.7	1.90	6.8	1.94	7.0	1.99	7.2	2.05
	29	5.9	1.73	6.2	1.82	6.4	1.88	6.5	1.92	6.7	1.96	6.9	2.01	7.1	2.07
	31	5.8	1.74	6.1	1.84	6.3	1.90	6.4	1.94	6.5	1.98	6.7	2.03	6.9	2.09
	33	5.7	1.76	6.0	1.86	6.2	1.92	6.3	1.96	6.4	2.00	6.6	2.05	6.8	2.11
	35	5.5	1.78	5.9	1.88	6.0	1.94	6.2	1.98	6.3	2.02	6.5	2.07	6.7	2.13
	37	5.4	1.79	5.7	1.89	5.9	1.95	6.0	1.99	6.2	2.03	6.3	2.09	6.5	2.14
	39	5.3	1.80	5.6	1.90	5.8	1.96	5.9	2.00	6.0	2.04	6.2	2.10	6.4	2.16
41	5.2	1.81	5.5	1.91	5.7	1.97	5.8	2.01	5.9	2.05	6.1	2.11	6.3	2.17	
43	5.1	1.81	5.4	1.92	5.6	1.98	5.7	2.02	5.8	2.06	6.0	2.12	6.1	2.18	
45	5.0	1.82	5.3	1.92	5.5	1.99	5.6	2.03	5.7	2.07	5.8	2.13	6.0	2.19	
48	4.9	1.83	5.2	1.93	5.3	2.00	5.5	2.04	5.6	2.08	5.7	2.14	5.9	2.20	
50	4.8	1.84	5.1	1.94	5.2	2.01	5.3	2.05	5.5	2.09	5.6	2.15	5.8	2.21	
52	4.7	1.85	5.0	1.95	5.1	2.02	5.2	2.06	5.3	2.10	5.5	2.16	5.7	2.22	
55	4.6	1.86	4.9	1.96	5.0	2.03	5.1	2.07	5.2	2.11	5.4	2.17	5.5	2.23	
60%	-5	3.6	0.65	3.8	0.69	3.9	0.71	4.0	0.72	4.1	0.74	4.2	0.76	4.3	0.78
	-2	3.5	0.66	3.7	0.69	3.8	0.71	3.9	0.73	4.0	0.74	4.1	0.77	4.2	0.79
	0	3.4	0.66	3.6	0.70	3.8	0.72	3.8	0.74	3.9	0.75	4.0	0.77	4.1	0.80
	2	3.4	0.67	3.6	0.71	3.7	0.73	3.8	0.74	3.8	0.76	3.9	0.78	4.1	0.80
	4	3.3	0.68	3.5	0.71	3.6	0.74	3.7	0.75	3.8	0.77	3.9	0.79	4.0	0.81
	6	3.2	0.68	3.4	0.72	3.5	0.74	3.6	0.76	3.7	0.77	3.8	0.80	3.9	0.82
	8	3.2	0.69	3.4	0.73	3.5	0.75	3.5	0.77	3.6	0.78	3.7	0.80	3.8	0.83
	10	4.3	0.92	4.5	0.97	4.6	1.00	4.7	1.02	4.8	1.04	5.0	1.07	5.1	1.10
	12	4.2	0.95	4.4	1.01	4.5	1.04	4.6	1.06	4.7	1.08	4.9	1.11	5.0	1.14
	14	4.1	0.99	4.3	1.05	4.5	1.08	4.6	1.10	4.6	1.13	4.8	1.16	4.9	1.19
	16	4.0	1.03	4.2	1.09	4.4	1.13	4.5	1.15	4.6	1.17	4.7	1.21	4.8	1.24
	18	4.7	1.16	4.9	1.22	5.1	1.26	5.2	1.29	5.3	1.31	5.4	1.35	5.6	1.39
	20	4.6	1.17	4.8	1.24	5.0	1.28	5.1	1.30	5.2	1.33	5.3	1.37	5.5	1.41
	21	4.5	1.18	4.7	1.25	4.9	1.29	5.0	1.31	5.1	1.34	5.2	1.38	5.4	1.42
	23	4.4	1.20	4.6	1.26	4.8	1.30	4.9	1.33	5.0	1.35	5.1	1.39	5.3	1.43
	25	4.3	1.21	4.5	1.27	4.7	1.31	4.8	1.34	4.9	1.37	5.0	1.41	5.2	1.45
	27	5.3	1.51	5.6	1.59	5.8	1.64	5.9	1.67	6.0	1.71	6.2	1.76	6.4	1.81
	29	5.2	1.52	5.5	1.61	5.7	1.66	5.8	1.69	5.9	1.72	6.1	1.77	6.2	1.83
	31	5.1	1.54	5.4	1.62	5.5	1.67	5.7	1.71	5.8	1.74	5.9	1.79	6.1	1.84
	33	5.0	1.55	5.3	1.64	5.4	1.69	5.5	1.72	5.7	1.76	5.8	1.81	6.0	1.86
	35	4.9	1.57	5.2	1.65	5.3	1.71	5.4	1.74	5.5	1.78	5.7	1.83	5.9	1.88
	37	4.8	1.58	5.1	1.66	5.2	1.72	5.3	1.75	5.4	1.79	5.6	1.84	5.8	1.89
	39	4.7	1.58	5.0	1.67	5.1	1.72	5.2	1.76	5.3	1.79	5.5	1.85	5.6	1.90
41	4.6	1.59	4.9	1.68	5.0	1.73	5.1	1.77	5.2	1.80	5.4	1.86	5.5	1.91	
43	4.5	1.60	4.8	1.69	4.9	1.74	5.0	1.78	5.1	1.81	5.3	1.87	5.4	1.92	
45	4.4	1.61	4.7	1.70	4.8	1.75	4.9	1.79	5.0	1.82	5.2	1.88	5.3	1.93	
48	4.3	1.62	4.6	1.71	4.7	1.76	4.8	1.79	4.9	1.83	5.1	1.88	5.2	1.94	
50	4.3	1.62	4.5	1.71	4.6	1.77	4.7	1.80	4.8	1.84	5.0	1.89	5.1	1.95	
52	4.2	1.63	4.4	1.72	4.5	1.78	4.6	1.81	4.7	1.85	4.9	1.90	5.0	1.96	
55	4.1	1.64	4.3	1.73	4.4	1.79	4.5	1.82	4.6	1.86	4.8	1.91	4.9	1.97	

# VNMF Mini VRF 50/60Hz

Combination (%) (Capacity index)	Outdoor Air temperature (° C DB)	Indoor temperature (° C WB)													
		DB: 20.8, WB: 14		DB: 23.3, WB: 16		DB: 25.8, WB: 18		DB: 27, WB: 19		DB: 28.2, WB: 20		DB: 30.7, WB: 22		DB: 32, WB: 24	
		TC	PI	TC	PI	TC	PI	TC	PI	TC	PI	TC	PI	TC	PI
50%	-5	3.1	0.56	3.3	0.59	3.4	0.61	3.5	0.62	3.5	0.64	3.6	0.66	3.7	0.67
	-2	3.0	0.57	3.2	0.60	3.3	0.62	3.4	0.63	3.5	0.64	3.6	0.66	3.7	0.68
	0	3.0	0.57	3.2	0.61	3.3	0.62	3.3	0.64	3.4	0.65	3.5	0.67	3.6	0.69
	2	2.9	0.58	3.1	0.61	3.2	0.63	3.3	0.64	3.3	0.66	3.4	0.68	3.5	0.70
	4	2.9	0.59	3.0	0.62	3.1	0.64	3.2	0.65	3.3	0.66	3.4	0.68	3.4	0.70
	6	2.8	0.59	3.0	0.62	3.1	0.64	3.1	0.66	3.2	0.67	3.3	0.69	3.4	0.71
	8	2.8	0.60	2.9	0.63	3.0	0.65	3.1	0.66	3.1	0.68	3.2	0.70	3.3	0.72
	10	3.7	0.79	3.9	0.84	4.0	0.86	4.1	0.88	4.2	0.90	4.3	0.92	4.4	0.95
	12	3.6	0.83	3.8	0.87	3.9	0.90	4.0	0.92	4.1	0.94	4.2	0.96	4.3	0.99
	14	3.6	0.86	3.8	0.91	3.9	0.94	3.9	0.96	4.0	0.97	4.1	1.00	4.3	1.03
	16	3.5	0.90	3.7	0.95	3.8	0.98	3.9	1.00	3.9	1.02	4.1	1.05	4.2	1.07
	18	4.0	1.00	4.3	1.06	4.4	1.09	4.5	1.12	4.6	1.14	4.7	1.17	4.9	1.20
	20	4.0	1.01	4.2	1.07	4.3	1.10	4.4	1.13	4.5	1.15	4.6	1.18	4.8	1.22
	21	3.9	1.02	4.1	1.08	4.2	1.12	4.3	1.14	4.4	1.16	4.5	1.19	4.7	1.23
	23	3.8	1.03	4.0	1.09	4.2	1.13	4.2	1.15	4.3	1.17	4.4	1.21	4.6	1.24
	25	3.7	1.05	3.9	1.10	4.1	1.14	4.2	1.16	4.2	1.18	4.4	1.22	4.5	1.25
	27	4.6	1.30	4.9	1.38	5.0	1.42	5.1	1.45	5.2	1.48	5.4	1.52	5.5	1.56
	29	4.5	1.32	4.8	1.39	4.9	1.43	5.0	1.46	5.1	1.49	5.3	1.54	5.4	1.58
	31	4.4	1.33	4.7	1.40	4.8	1.45	4.9	1.48	5.0	1.51	5.2	1.55	5.3	1.60
	33	4.3	1.34	4.6	1.42	4.7	1.46	4.8	1.49	4.9	1.52	5.1	1.57	5.2	1.61
35	4.2	1.36	4.5	1.43	4.6	1.48	4.7	1.51	4.8	1.54	5.0	1.58	5.1	1.63	
37	4.2	1.36	4.4	1.44	4.5	1.49	4.6	1.52	4.7	1.55	4.9	1.59	5.0	1.64	
39	4.1	1.37	4.3	1.45	4.4	1.49	4.5	1.52	4.6	1.55	4.8	1.60	4.9	1.64	
41	4.0	1.38	4.2	1.45	4.4	1.50	4.4	1.53	4.5	1.56	4.7	1.61	4.8	1.65	
43	3.9	1.38	4.1	1.46	4.3	1.51	4.4	1.54	4.4	1.57	4.6	1.62	4.7	1.66	
45	3.8	1.39	4.1	1.47	4.2	1.52	4.3	1.55	4.4	1.58	4.5	1.62	4.6	1.67	
48	3.8	1.40	4.0	1.48	4.1	1.52	4.2	1.55	4.3	1.58	4.4	1.63	4.5	1.68	
50	3.7	1.41	3.9	1.48	4.0	1.53	4.1	1.56	4.2	1.59	4.3	1.64	4.4	1.69	
52	3.6	1.41	3.8	1.49	3.9	1.54	4.0	1.57	4.1	1.60	4.2	1.65	4.3	1.69	
55	3.5	1.42	3.7	1.50	3.9	1.55	3.9	1.58	4.0	1.61	4.1	1.66	4.3	1.70	

VNMF235Q0A-G05V100

TC: Total Capacity (kW); PI: Power Input (kW) (Compressor + Outdoor fan motor)

Combination (%) (Capacity index)	Outdoor Air temperature (° C DB)	Indoor temperature (° C WB)													
		DB: 20.8, WB: 14		DB: 23.3, WB: 16		DB: 25.8, WB: 18		DB: 27, WB: 19		DB: 28.2, WB: 20		DB: 30.7, WB: 22		DB: 32, WB: 24	
		TC kW	PI kW	TC kW	PI kW	TC kW	PI kW	TC kW	PI kW	TC kW	PI kW	TC kW	PI kW	TC kW	PI kW
130%	-5	7.0	1.16	7.4	1.23	7.7	1.27	7.8	1.29	8.0	1.32	8.2	1.36	8.5	1.40
	-2	6.9	1.17	7.3	1.24	7.5	1.28	7.7	1.31	7.8	1.33	8.1	1.37	8.3	1.41
	0	6.8	1.19	7.2	1.25	7.4	1.29	7.5	1.32	7.7	1.35	7.9	1.38	8.1	1.42
	2	6.6	1.20	7.0	1.27	7.2	1.31	7.4	1.33	7.5	1.36	7.7	1.40	8.0	1.44
	4	6.5	1.21	6.9	1.28	7.1	1.32	7.2	1.35	7.4	1.37	7.6	1.41	7.8	1.45
	6	6.4	1.22	6.7	1.29	7.0	1.33	7.1	1.36	7.2	1.39	7.4	1.43	7.7	1.47
	8	6.3	1.24	6.6	1.30	6.8	1.35	7.0	1.37	7.1	1.40	7.3	1.44	7.5	1.48
	10	8.4	1.64	8.8	1.73	9.1	1.79	9.3	1.82	9.5	1.86	9.8	1.91	10.1	1.97
	12	8.2	1.71	8.7	1.80	8.9	1.86	9.1	1.90	9.3	1.94	9.6	1.99	9.9	2.05
	14	8.1	1.78	8.5	1.88	8.8	1.94	8.9	1.98	9.1	2.02	9.4	2.08	9.7	2.13
	16	7.9	1.85	8.3	1.96	8.6	2.02	8.8	2.06	8.9	2.10	9.2	2.16	9.5	2.22
	18	9.2	2.08	9.7	2.19	10.0	2.26	10.2	2.31	10.4	2.35	10.7	2.42	11.0	2.49
	20	9.0	2.10	9.5	2.21	9.8	2.28	10.0	2.33	10.2	2.38	10.5	2.45	10.8	2.52
	21	8.8	2.12	9.3	2.24	9.6	2.31	9.8	2.35	10.0	2.40	10.3	2.47	10.6	2.54
	23	8.6	2.14	9.1	2.26	9.4	2.33	9.6	2.38	9.8	2.43	10.1	2.50	10.4	2.57
	25	8.5	2.16	8.9	2.28	9.2	2.35	9.4	2.40	9.6	2.45	9.9	2.52	10.2	2.59
	27	10.4	2.70	11.0	2.85	11.4	2.94	11.6	3.00	11.8	3.06	12.2	3.15	12.5	3.24
	29	10.2	2.72	10.8	2.88	11.1	2.97	11.4	3.03	11.6	3.09	11.9	3.18	12.3	3.27
	31	10.0	2.75	10.6	2.91	10.9	3.00	11.1	3.06	11.4	3.12	11.7	3.21	12.0	3.30
	33	9.8	2.78	10.4	2.93	10.7	3.03	10.9	3.09	11.1	3.15	11.5	3.24	11.8	3.34
35	9.6	2.81	10.2	2.96	10.5	3.06	10.7	3.12	10.9	3.18	11.2	3.28	11.6	3.37	
37	9.4	2.82	10.0	2.98	10.3	3.07	10.5	3.14	10.7	3.20	11.0	3.29	11.3	3.39	
39	9.0	2.77	9.5	2.92	9.8	3.01	10.0	3.07	10.2	3.13	10.5	3.23	10.8	3.32	
41	8.5	2.71	9.0	2.86	9.3	2.95	9.5	3.01	9.7	3.07	9.9	3.16	10.2	3.25	
43	8.1	2.66	8.5	2.80	8.8	2.89	9.0	2.95	9.2	3.01	9.4	3.10	9.7	3.19	
45	7.7	2.58	8.1	2.72	8.4	2.81	8.5	2.86	8.7	2.92	9.0	3.01	9.2	3.09	
48	7.3	2.45	7.7	2.58	8.0	2.67	8.1	2.72	8.3	2.77	8.5	2.86	8.8	2.94	
50	6.9	2.25	7.3	2.38	7.6	2.45	7.7	2.50	7.9	2.55	8.1	2.63	8.3	2.70	
52	6.6	2.07	7.0	2.19	7.2	2.26	7.3	2.30	7.5	2.35	7.7	2.42	7.9	2.49	
55	6.3	1.91	6.6	2.01	6.8	2.08	7.0	2.12	7.1	2.16	7.3	2.22	7.5	2.29	
120%	-5	6.9	1.15	7.3	1.22	7.5	1.25	7.7	1.28	7.8	1.31	8.1	1.34	8.3	1.38
	-2	6.8	1.16	7.2	1.23	7.4	1.27	7.5	1.29	7.7	1.32	7.9	1.36	8.1	1.40
	0	6.6	1.18	7.0	1.24	7.2	1.28	7.4	1.31	7.5	1.33	7.8	1.37	8.0	1.41
	2	6.5	1.19	6.9	1.25	7.1	1.29	7.2	1.32	7.4	1.35	7.6	1.39	7.8	1.42
	4	6.4	1.20	6.7	1.27	7.0	1.31	7.1	1.33	7.2	1.36	7.5	1.40	7.7	1.44
	6	6.3	1.21	6.6	1.28	6.8	1.32	7.0	1.35	7.1	1.37	7.3	1.41	7.5	1.45
	8	6.1	1.22	6.5	1.29	6.7	1.33	6.8	1.36	7.0	1.39	7.2	1.43	7.4	1.47
	10	8.2	1.62	8.7	1.71	9.0	1.77	9.1	1.80	9.3	1.84	9.6	1.89	9.9	1.95
	12	8.1	1.69	8.5	1.79	8.8	1.84	9.0	1.88	9.1	1.92	9.4	1.97	9.7	2.03
	14	7.9	1.76	8.3	1.86	8.6	1.92	8.8	1.96	9.0	2.00	9.2	2.06	9.5	2.11
	16	7.7	1.84	8.2	1.94	8.4	2.00	8.6	2.04	8.8	2.08	9.0	2.14	9.3	2.20
	18	9.0	2.06	9.5	2.17	9.8	2.24	10.0	2.29	10.2	2.33	10.5	2.40	10.8	2.47
	20	8.8	2.08	9.3	2.19	9.6	2.26	9.8	2.31	10.0	2.35	10.3	2.42	10.6	2.49
	21	8.7	2.10	9.1	2.22	9.4	2.29	9.6	2.33	9.8	2.38	10.1	2.45	10.4	2.52
	23	8.5	2.12	9.0	2.24	9.2	2.31	9.4	2.36	9.6	2.40	9.9	2.47	10.2	2.54
	25	8.3	2.14	8.8	2.26	9.1	2.33	9.2	2.38	9.4	2.43	9.7	2.50	10.0	2.57
	27	10.2	2.67	10.8	2.82	11.1	2.91	11.4	2.97	11.6	3.03	11.9	3.12	12.3	3.21
	29	10.0	2.70	10.6	2.85	10.9	2.94	11.1	3.00	11.4	3.06	11.7	3.15	12.0	3.24
	31	9.8	2.73	10.4	2.88	10.7	2.97	10.9	3.03	11.1	3.09	11.5	3.18	11.8	3.27
	33	9.6	2.75	10.2	2.91	10.5	3.00	10.7	3.06	10.9	3.12	11.2	3.21	11.6	3.30
35	9.5	2.78	10.0	2.94	10.3	3.03	10.5	3.09	10.7	3.15	11.0	3.24	11.3	3.34	
37	9.3	2.79	9.8	2.95	10.1	3.04	10.3	3.11	10.5	3.17	10.8	3.26	11.1	3.35	
39	8.8	2.74	9.3	2.89	9.6	2.98	9.8	3.04	10.0	3.10	10.3	3.20	10.6	3.29	
41	8.4	2.68	8.8	2.83	9.1	2.92	9.3	2.98	9.5	3.04	9.8	3.13	10.0	3.22	
43	7.9	2.63	8.4	2.78	8.6	2.86	8.8	2.92	9.0	2.98	9.3	3.07	9.5	3.16	
45	7.5	2.55	8.0	2.69	8.2	2.78	8.4	2.84	8.5	2.89	8.8	2.98	9.1	3.06	
48	7.2	2.42	7.6	2.56	7.8	2.64	8.0	2.69	8.1	2.75	8.4	2.83	8.6	2.91	
50	6.8	2.23	7.2	2.35	7.4	2.43	7.6	2.48	7.7	2.53	7.9	2.60	8.2	2.68	
52	6.5	2.05	6.8	2.17	7.0	2.23	7.2	2.28	7.3	2.33	7.5	2.39	7.8	2.46	
55	6.1	1.89	6.5	1.99	6.7	2.06	6.8	2.10	7.0	2.14	7.2	2.20	7.4	2.27	

# VNMF Mini VRF 50/60Hz

Combination (%) (Capacity index)	Outdoor Air temperature (° C DB)	Indoor temperature (° C WB)													
		DB: 20.8, WB: 14		DB: 23.3, WB: 16		DB: 25.8, WB: 18		DB: 27, WB: 19		DB: 28.2, WB: 20		DB: 30.7, WB: 22		DB: 32, WB: 24	
		TC	PI	TC	PI	TC	PI	TC	PI	TC	PI	TC	PI	TC	PI
		kW	kW	kW	kW	kW	kW	kW	kW	kW	kW	kW	kW	kW	kW
110%	-5	6.8	1.14	7.2	1.20	7.4	1.24	7.5	1.27	7.7	1.29	7.9	1.33	8.1	1.37
	-2	6.7	1.15	7.0	1.22	7.2	1.25	7.4	1.28	7.5	1.31	7.8	1.34	8.0	1.38
	0	6.5	1.16	6.9	1.23	7.1	1.27	7.2	1.29	7.4	1.32	7.6	1.36	7.8	1.40
	2	6.4	1.18	6.7	1.24	7.0	1.28	7.1	1.31	7.2	1.33	7.5	1.37	7.7	1.41
	4	6.3	1.19	6.6	1.25	6.8	1.29	7.0	1.32	7.1	1.35	7.3	1.39	7.5	1.43
	6	6.1	1.20	6.5	1.27	6.7	1.31	6.8	1.33	7.0	1.36	7.2	1.40	7.4	1.44
	8	6.0	1.21	6.4	1.28	6.6	1.32	6.7	1.35	6.8	1.37	7.0	1.41	7.2	1.45
	10	8.1	1.61	8.5	1.70	8.8	1.75	9.0	1.79	9.1	1.82	9.4	1.88	9.7	1.93
	12	7.9	1.68	8.3	1.77	8.6	1.82	8.8	1.86	9.0	1.90	9.2	1.95	9.5	2.01
	14	7.8	1.74	8.2	1.84	8.4	1.90	8.6	1.94	8.8	1.98	9.0	2.04	9.3	2.09
	16	7.6	1.82	8.0	1.92	8.3	1.98	8.4	2.02	8.6	2.06	8.9	2.12	9.1	2.18
	18	8.8	2.04	9.3	2.15	9.6	2.22	9.8	2.26	10.0	2.31	10.3	2.38	10.6	2.44
	20	8.7	2.06	9.1	2.17	9.4	2.24	9.6	2.29	9.8	2.33	10.1	2.40	10.4	2.47
	21	8.5	2.08	9.0	2.19	9.2	2.26	9.4	2.31	9.6	2.36	9.9	2.42	10.2	2.49
	23	8.3	2.10	8.8	2.22	9.1	2.29	9.2	2.33	9.4	2.38	9.7	2.45	10.0	2.52
	25	8.2	2.12	8.6	2.24	8.9	2.31	9.1	2.36	9.2	2.40	9.5	2.47	9.8	2.54
	27	10.0	2.65	10.6	2.79	10.9	2.88	11.1	2.94	11.4	3.00	11.7	3.09	12.0	3.17
	29	9.8	2.67	10.4	2.82	10.7	2.91	10.9	2.97	11.1	3.03	11.5	3.12	11.8	3.21
	31	9.6	2.70	10.2	2.85	10.5	2.94	10.7	3.00	10.9	3.06	11.3	3.15	11.6	3.24
	33	9.5	2.73	10.0	2.88	10.3	2.97	10.5	3.03	10.7	3.09	11.0	3.18	11.3	3.27
35	9.3	2.75	9.8	2.91	10.1	3.00	10.3	3.06	10.5	3.12	10.8	3.21	11.1	3.30	
37	9.1	2.77	9.6	2.92	9.9	3.01	10.1	3.08	10.3	3.14	10.6	3.23	10.9	3.32	
39	8.6	2.71	9.1	2.86	9.4	2.95	9.6	3.01	9.8	3.07	10.1	3.16	10.4	3.25	
41	8.2	2.66	8.7	2.81	8.9	2.89	9.1	2.95	9.3	3.01	9.6	3.10	9.8	3.19	
43	7.8	2.61	8.2	2.75	8.5	2.84	8.7	2.89	8.8	2.95	9.1	3.04	9.3	3.13	
45	7.4	2.53	7.8	2.67	8.1	2.75	8.2	2.81	8.4	2.86	8.6	2.95	8.9	3.03	
48	7.0	2.40	7.4	2.53	7.7	2.61	7.8	2.67	8.0	2.72	8.2	2.80	8.4	2.88	
50	6.7	2.21	7.0	2.33	7.3	2.40	7.4	2.45	7.6	2.50	7.8	2.58	8.0	2.65	
52	6.3	2.03	6.7	2.14	6.9	2.21	7.0	2.26	7.2	2.30	7.4	2.37	7.6	2.44	
55	6.0	1.87	6.4	1.97	6.6	2.04	6.7	2.08	6.8	2.12	7.0	2.18	7.2	2.24	
100%	-5	6.6	1.12	7.0	1.18	7.2	1.22	7.3	1.24	7.5	1.27	7.7	1.30	7.9	1.34
	-2	6.5	1.13	6.8	1.19	7.0	1.23	7.2	1.26	7.3	1.28	7.5	1.32	7.8	1.36
	0	6.3	1.14	6.7	1.20	6.9	1.24	7.0	1.27	7.2	1.29	7.4	1.33	7.6	1.37
	2	6.2	1.15	6.6	1.22	6.8	1.26	6.9	1.28	7.0	1.31	7.2	1.34	7.4	1.38
	4	6.1	1.16	6.4	1.23	6.6	1.27	6.8	1.29	6.9	1.32	7.1	1.36	7.3	1.40
	6	6.0	1.18	6.3	1.24	6.5	1.28	6.6	1.31	6.8	1.33	7.0	1.37	7.2	1.41
	8	5.9	1.19	6.2	1.25	6.4	1.29	6.5	1.32	6.6	1.35	6.8	1.39	7.0	1.43
	10	7.8	1.58	8.3	1.66	8.5	1.72	8.7	1.75	8.9	1.79	9.1	1.84	9.4	1.89
	12	7.7	1.64	8.1	1.73	8.4	1.79	8.5	1.82	8.7	1.86	9.0	1.92	9.2	1.97
	14	7.5	1.71	7.9	1.81	8.2	1.86	8.4	1.90	8.5	1.94	8.8	2.00	9.0	2.05
	16	7.4	1.78	7.8	1.88	8.0	1.94	8.2	1.98	8.4	2.02	8.6	2.08	8.9	2.14
	18	8.6	2.00	9.0	2.11	9.3	2.17	9.5	2.22	9.7	2.26	10.0	2.33	10.3	2.40
	20	8.4	2.02	8.9	2.13	9.2	2.20	9.3	2.24	9.5	2.29	9.8	2.35	10.1	2.42
	21	8.2	2.04	8.7	2.15	9.0	2.22	9.2	2.26	9.3	2.31	9.6	2.38	9.9	2.45
	23	8.1	2.06	8.5	2.17	8.8	2.24	9.0	2.29	9.2	2.33	9.4	2.40	9.7	2.47
	25	7.9	2.08	8.4	2.19	8.6	2.26	8.8	2.31	9.0	2.36	9.2	2.43	9.5	2.49
	27	9.7	2.59	10.3	2.74	10.6	2.82	10.8	2.88	11.0	2.94	11.4	3.03	11.7	3.11
	29	9.6	2.62	10.1	2.77	10.4	2.85	10.6	2.91	10.8	2.97	11.1	3.06	11.5	3.14
	31	9.4	2.65	9.9	2.79	10.2	2.88	10.4	2.94	10.6	3.00	10.9	3.09	11.2	3.18
	33	9.2	2.67	9.7	2.82	10.0	2.91	10.2	2.97	10.4	3.03	10.7	3.12	11.0	3.21
35	9.0	2.70	9.5	2.85	9.8	2.94	10.0	3.00	10.2	3.06	10.5	3.15	10.8	3.24	
37	8.8	2.71	9.3	2.86	9.6	2.95	9.8	3.05	10.0	3.08	10.3	3.17	10.6	3.26	
39	8.4	2.66	8.8	2.81	9.1	2.90	9.6	3.10	9.5	3.01	9.8	3.10	10.1	3.19	
41	8.0	2.61	8.4	2.75	8.7	2.84	9.4	3.15	9.0	2.95	9.3	3.04	9.6	3.13	
43	7.6	2.55	8.0	2.70	8.2	2.78	9.2	3.20	8.6	2.89	8.8	2.98	9.1	3.06	
45	7.2	2.48	7.6	2.61	7.8	2.70	8.1	3.25	8.1	2.81	8.4	2.89	8.6	2.97	
48	6.8	2.35	7.2	2.48	7.4	2.56	7.7	3.30	7.7	2.67	8.0	2.75	8.2	2.82	
50	6.5	2.17	6.8	2.29	7.1	2.36	7.3	3.35	7.3	2.45	7.6	2.53	7.8	2.60	
52	6.2	1.99	6.5	2.10	6.7	2.17	6.9	3.41	7.0	2.26	7.2	2.32	7.4	2.39	
55	5.9	1.83	6.2	1.93	6.4	2.00	6.6	3.46	6.6	2.08	6.8	2.14	7.0	2.20	

Combination (%) (Capacity index)	Outdoor Air temperature (° C DB)	Indoor temperature (° C WB)													
		DB: 20.8, WB: 14		DB: 23.3, WB: 16		DB: 25.8, WB: 18		DB: 27, WB: 19		DB: 28.2, WB: 20		DB: 30.7, WB: 22		DB: 32, WB: 24	
		TC	PI	TC	PI	TC	PI	TC	PI	TC	PI	TC	PI	TC	PI
		kW	kW	kW	kW	kW	kW	kW	kW	kW	kW	kW	kW	kW	kW
90%	-5	6.3	1.05	6.6	1.11	6.8	1.14	7.0	1.17	7.1	1.19	7.3	1.23	7.5	1.26
	-2	6.1	1.06	6.5	1.12	6.7	1.16	6.8	1.18	7.0	1.20	7.2	1.24	7.4	1.27
	0	6.0	1.07	6.3	1.13	6.6	1.17	6.7	1.19	6.8	1.22	7.0	1.25	7.2	1.29
	2	5.9	1.08	6.2	1.14	6.4	1.18	6.6	1.20	6.7	1.23	6.9	1.26	7.1	1.30
	4	5.8	1.09	6.1	1.16	6.3	1.19	6.4	1.22	6.6	1.24	6.7	1.28	6.9	1.31
	6	5.7	1.11	6.0	1.17	6.2	1.20	6.3	1.23	6.4	1.25	6.6	1.29	6.8	1.33
	8	5.6	1.12	5.9	1.18	6.1	1.22	6.2	1.24	6.3	1.27	6.5	1.30	6.7	1.34
	10	7.4	1.48	7.9	1.56	8.1	1.61	8.3	1.65	8.4	1.68	8.7	1.73	8.9	1.78
	12	7.3	1.54	7.7	1.63	7.9	1.68	8.1	1.72	8.3	1.75	8.5	1.80	8.8	1.85
	14	7.2	1.61	7.5	1.70	7.8	1.75	7.9	1.79	8.1	1.82	8.3	1.88	8.6	1.93
	16	7.0	1.68	7.4	1.77	7.6	1.82	7.8	1.86	7.9	1.90	8.2	1.95	8.4	2.01
	18	8.1	1.88	8.6	1.98	8.9	2.04	9.0	2.09	9.2	2.13	9.5	2.19	9.8	2.25
	20	8.0	1.90	8.4	2.00	8.7	2.06	8.9	2.11	9.0	2.15	9.3	2.21	9.6	2.28
	21	7.8	1.92	8.3	2.02	8.5	2.09	8.7	2.13	8.9	2.17	9.1	2.23	9.4	2.30
	23	7.7	1.93	8.1	2.04	8.4	2.11	8.5	2.15	8.7	2.19	9.0	2.26	9.2	2.32
	25	7.5	1.95	7.9	2.06	8.2	2.13	8.4	2.17	8.5	2.21	8.8	2.28	9.0	2.35
	27	9.3	2.44	9.8	2.57	10.1	2.65	10.3	2.71	10.5	2.76	10.8	2.84	11.1	2.93
	29	9.1	2.46	9.6	2.60	9.9	2.68	10.1	2.74	10.3	2.79	10.6	2.87	10.9	2.96
	31	8.9	2.49	9.4	2.63	9.7	2.71	9.9	2.76	10.1	2.82	10.4	2.90	10.7	2.98
	33	8.7	2.51	9.2	2.65	9.5	2.74	9.7	2.79	9.9	2.85	10.2	2.93	10.5	3.02
35	8.6	2.54	9.0	2.68	9.3	2.76	9.5	2.82	9.7	2.88	10.0	2.96	10.3	3.05	
37	8.4	2.55	8.8	2.69	9.1	2.78	9.3	2.83	9.5	2.89	9.8	2.98	10.1	3.06	
39	8.0	2.50	8.4	2.64	8.7	2.72	8.8	2.78	9.0	2.83	9.3	2.92	9.6	3.00	
41	7.6	2.45	8.0	2.59	8.2	2.67	8.4	2.72	8.6	2.78	8.8	2.86	9.1	2.94	
43	7.2	2.40	7.6	2.53	7.8	2.61	8.0	2.67	8.1	2.72	8.4	2.80	8.6	2.88	
45	6.8	2.33	7.2	2.46	7.4	2.54	7.6	2.59	7.7	2.64	8.0	2.72	8.2	2.79	
48	6.5	2.21	6.8	2.34	7.1	2.41	7.2	2.46	7.3	2.51	7.6	2.58	7.8	2.65	
50	6.2	2.04	6.5	2.15	6.7	2.22	6.8	2.26	7.0	2.31	7.2	2.37	7.4	2.44	
52	5.9	1.87	6.2	1.98	6.4	2.04	6.5	2.08	6.6	2.12	6.8	2.18	7.0	2.25	
55	5.6	1.72	5.9	1.82	6.1	1.88	6.2	1.91	6.3	1.95	6.5	2.01	6.7	2.07	
80%	-5	5.7	0.95	6.0	1.00	6.2	1.04	6.3	1.06	6.4	1.08	6.6	1.11	6.8	1.14
	-2	5.6	0.96	5.9	1.01	6.0	1.05	6.2	1.07	6.3	1.09	6.5	1.12	6.7	1.15
	0	5.4	0.97	5.7	1.02	5.9	1.06	6.1	1.08	6.2	1.10	6.4	1.13	6.5	1.16
	2	5.3	0.98	5.6	1.03	5.8	1.07	5.9	1.09	6.1	1.11	6.2	1.14	6.4	1.18
	4	5.2	0.99	5.5	1.04	5.7	1.08	5.8	1.10	5.9	1.12	6.1	1.15	6.3	1.19
	6	5.1	1.00	5.4	1.06	5.6	1.09	5.7	1.11	5.8	1.13	6.0	1.17	6.2	1.20
	8	5.0	1.01	5.3	1.07	5.5	1.10	5.6	1.12	5.7	1.14	5.9	1.18	6.0	1.21
	10	6.7	1.34	7.1	1.41	7.3	1.46	7.5	1.49	7.6	1.52	7.9	1.56	8.1	1.61
	12	6.6	1.40	7.0	1.47	7.2	1.52	7.3	1.55	7.5	1.58	7.7	1.63	7.9	1.68
	14	6.5	1.45	6.8	1.53	7.0	1.58	7.2	1.62	7.3	1.65	7.6	1.70	7.8	1.74
	16	6.3	1.51	6.7	1.60	6.9	1.65	7.1	1.68	7.2	1.72	7.4	1.77	7.6	1.82
	18	7.4	1.70	7.8	1.79	8.0	1.85	8.2	1.89	8.4	1.92	8.6	1.98	8.8	2.04
	20	7.2	1.71	7.6	1.81	7.9	1.87	8.0	1.91	8.2	1.94	8.4	2.00	8.7	2.06
	21	7.1	1.73	7.5	1.83	7.7	1.89	7.9	1.92	8.0	1.96	8.3	2.02	8.5	2.08
	23	6.9	1.75	7.3	1.85	7.6	1.90	7.7	1.94	7.9	1.98	8.1	2.04	8.3	2.10
	25	6.8	1.77	7.2	1.87	7.4	1.92	7.6	1.96	7.7	2.00	7.9	2.06	8.2	2.12
	27	8.4	2.20	8.8	2.33	9.1	2.40	9.3	2.45	9.5	2.50	9.8	2.57	10.1	2.65
	29	8.2	2.23	8.7	2.35	8.9	2.42	9.1	2.47	9.3	2.52	9.6	2.60	9.9	2.67
	31	8.1	2.25	8.5	2.37	8.8	2.45	8.9	2.50	9.1	2.55	9.4	2.62	9.7	2.70
	33	7.9	2.27	8.3	2.40	8.6	2.47	8.8	2.52	8.9	2.57	9.2	2.65	9.5	2.73
35	7.7	2.30	8.2	2.42	8.4	2.50	8.6	2.55	8.8	2.60	9.0	2.68	9.3	2.75	
37	7.6	2.31	8.0	2.43	8.3	2.51	8.4	2.56	8.6	2.61	8.8	2.69	9.1	2.77	
39	7.2	2.26	7.6	2.39	7.8	2.46	8.0	2.51	8.2	2.56	8.4	2.64	8.6	2.71	
41	6.8	2.22	7.2	2.34	7.5	2.41	7.6	2.46	7.8	2.51	8.0	2.58	8.2	2.66	
43	6.5	2.17	6.9	2.29	7.1	2.36	7.2	2.41	7.4	2.46	7.6	2.53	7.8	2.61	
45	6.2	2.11	6.5	2.22	6.7	2.29	6.9	2.34	7.0	2.39	7.2	2.46	7.4	2.53	
48	5.9	2.00	6.2	2.11	6.4	2.18	6.5	2.22	6.7	2.27	6.8	2.33	7.0	2.40	
50	5.6	1.84	5.9	1.94	6.1	2.00	6.2	2.04	6.3	2.09	6.5	2.15	6.7	2.21	
52	5.3	1.69	5.6	1.79	5.8	1.84	5.9	1.88	6.0	1.92	6.2	1.98	6.4	2.03	
55	5.0	1.56	5.3	1.64	5.5	1.70	5.6	1.73	5.7	1.77	5.9	1.82	6.0	1.87	



# VNMF Mini VRF 50/60Hz

Combination (%) (Capacity index)	Outdoor Air temperature (° C DB)	Indoor temperature (° C WB)													
		DB: 20.8, WB: 14		DB: 23.3, WB: 16		DB: 25.8, WB: 18		DB: 27, WB: 19		DB: 28.2, WB: 20		DB: 30.7, WB: 22		DB: 32, WB: 24	
		TC	PI	TC	PI	TC	PI	TC	PI	TC	PI	TC	PI	TC	PI
		kW	kW	kW	kW	kW	kW	kW	kW	kW	kW	kW	kW	kW	kW
70%	-5	5.1	0.85	5.4	0.90	5.5	0.93	5.6	0.94	5.7	0.96	5.9	0.99	6.1	1.02
	-2	5.0	0.86	5.2	0.91	5.4	0.93	5.5	0.95	5.6	0.97	5.8	1.00	6.0	1.03
	0	4.9	0.87	5.1	0.92	5.3	0.94	5.4	0.96	5.5	0.98	5.7	1.01	5.9	1.04
	2	4.8	0.88	5.0	0.92	5.2	0.95	5.3	0.97	5.4	0.99	5.6	1.02	5.7	1.05
	4	4.7	0.88	4.9	0.93	5.1	0.96	5.2	0.98	5.3	1.00	5.5	1.03	5.6	1.06
	6	4.6	0.89	4.8	0.94	5.0	0.97	5.1	0.99	5.2	1.01	5.4	1.04	5.5	1.07
	8	4.5	0.90	4.8	0.95	4.9	0.98	5.0	1.00	5.1	1.02	5.3	1.05	5.4	1.08
	10	6.0	1.20	6.4	1.26	6.6	1.30	6.7	1.33	6.8	1.36	7.0	1.40	7.2	1.44
	12	5.9	1.25	6.2	1.32	6.4	1.36	6.6	1.39	6.7	1.41	6.9	1.46	7.1	1.50
	14	5.8	1.30	6.1	1.37	6.3	1.42	6.4	1.44	6.6	1.47	6.8	1.52	7.0	1.56
	16	5.7	1.35	6.0	1.43	6.2	1.47	6.3	1.50	6.4	1.53	6.6	1.58	6.8	1.63
	18	6.6	1.52	7.0	1.60	7.2	1.65	7.3	1.69	7.5	1.72	7.7	1.77	7.9	1.82
	20	6.5	1.53	6.8	1.62	7.0	1.67	7.2	1.70	7.3	1.74	7.6	1.79	7.8	1.84
	21	6.3	1.55	6.7	1.63	6.9	1.69	7.0	1.72	7.2	1.76	7.4	1.81	7.6	1.86
	23	6.2	1.56	6.6	1.65	6.8	1.70	6.9	1.74	7.0	1.77	7.3	1.82	7.5	1.88
	25	6.1	1.58	6.4	1.67	6.6	1.72	6.8	1.76	6.9	1.79	7.1	1.84	7.3	1.90
	27	7.5	1.97	7.9	2.08	8.2	2.15	8.3	2.19	8.5	2.23	8.8	2.30	9.0	2.37
	29	7.4	1.99	7.8	2.10	8.0	2.17	8.2	2.21	8.3	2.26	8.6	2.32	8.8	2.39
	31	7.2	2.01	7.6	2.12	7.9	2.19	8.0	2.23	8.2	2.28	8.4	2.35	8.7	2.41
	33	7.1	2.03	7.5	2.14	7.7	2.21	7.9	2.26	8.0	2.30	8.2	2.37	8.5	2.44
35	6.9	2.05	7.3	2.17	7.5	2.23	7.7	2.28	7.9	2.33	8.1	2.39	8.3	2.46	
37	6.8	2.06	7.2	2.18	7.4	2.25	7.5	2.29	7.7	2.34	7.9	2.41	8.1	2.47	
39	6.7	2.07	7.0	2.19	7.2	2.26	7.4	2.30	7.5	2.35	7.8	2.42	8.0	2.49	
41	6.5	2.08	6.9	2.20	7.1	2.27	7.2	2.31	7.4	2.36	7.6	2.43	7.8	2.50	
43	6.4	2.09	6.7	2.21	7.0	2.28	7.1	2.33	7.2	2.37	7.5	2.44	7.7	2.51	
45	6.3	2.10	6.6	2.22	6.8	2.29	7.0	2.34	7.1	2.38	7.3	2.45	7.5	2.52	
48	6.1	2.11	6.5	2.23	6.7	2.30	6.8	2.35	7.0	2.40	7.2	2.47	7.4	2.54	
50	6.0	2.12	6.4	2.24	6.6	2.31	6.7	2.36	6.8	2.41	7.0	2.48	7.2	2.55	
52	5.9	2.14	6.2	2.25	6.4	2.33	6.6	2.37	6.7	2.42	6.9	2.49	7.1	2.56	
55	5.8	2.15	6.1	2.27	6.3	2.34	6.4	2.38	6.5	2.43	6.7	2.50	6.9	2.58	
60%	-5	4.5	0.75	4.7	0.79	4.9	0.82	5.0	0.83	5.1	0.85	5.2	0.87	5.4	0.90
	-2	4.4	0.76	4.6	0.80	4.8	0.82	4.9	0.84	5.0	0.86	5.1	0.88	5.3	0.91
	0	4.3	0.76	4.5	0.81	4.7	0.83	4.8	0.85	4.9	0.87	5.0	0.89	5.2	0.92
	2	4.2	0.77	4.5	0.82	4.6	0.84	4.7	0.86	4.8	0.88	4.9	0.90	5.1	0.93
	4	4.1	0.78	4.4	0.82	4.5	0.85	4.6	0.87	4.7	0.88	4.8	0.91	5.0	0.94
	6	4.1	0.79	4.3	0.83	4.4	0.86	4.5	0.88	4.6	0.89	4.7	0.92	4.9	0.95
	8	4.0	0.80	4.2	0.84	4.3	0.87	4.4	0.88	4.5	0.90	4.6	0.93	4.8	0.96
	10	5.3	1.06	5.6	1.12	5.8	1.15	5.9	1.17	6.0	1.20	6.2	1.23	6.4	1.27
	12	5.2	1.10	5.5	1.16	5.7	1.20	5.8	1.22	5.9	1.25	6.1	1.28	6.3	1.32
	14	5.1	1.15	5.4	1.21	5.6	1.25	5.7	1.27	5.8	1.30	6.0	1.34	6.1	1.38
	16	5.0	1.19	5.3	1.26	5.5	1.30	5.6	1.33	5.7	1.35	5.9	1.39	6.0	1.43
	18	5.8	1.34	6.2	1.41	6.3	1.46	6.5	1.49	6.6	1.52	6.8	1.56	7.0	1.61
	20	5.7	1.35	6.0	1.43	6.2	1.47	6.4	1.50	6.5	1.53	6.7	1.58	6.9	1.62
	21	5.6	1.37	5.9	1.44	6.1	1.49	6.2	1.52	6.4	1.55	6.5	1.59	6.7	1.64
	23	5.5	1.38	5.8	1.46	6.0	1.50	6.1	1.53	6.2	1.56	6.4	1.61	6.6	1.65
	25	5.4	1.39	5.7	1.47	5.9	1.52	6.0	1.55	6.1	1.58	6.3	1.63	6.5	1.67
	27	6.6	1.74	7.0	1.83	7.2	1.89	7.4	1.93	7.5	1.97	7.7	2.03	7.9	2.09
	29	6.5	1.76	6.9	1.85	7.1	1.91	7.2	1.95	7.4	1.99	7.6	2.05	7.8	2.11
	31	6.4	1.77	6.7	1.87	6.9	1.93	7.1	1.97	7.2	2.01	7.4	2.07	7.6	2.13
	33	6.2	1.79	6.6	1.89	6.8	1.95	6.9	1.99	7.1	2.03	7.3	2.09	7.5	2.15
35	6.1	1.81	6.5	1.91	6.7	1.97	6.8	2.01	6.9	2.05	7.1	2.11	7.3	2.17	
37	6.0	1.82	6.3	1.92	6.5	1.98	6.7	2.02	6.8	2.06	7.0	2.12	7.2	2.18	
39	5.9	1.83	6.2	1.93	6.4	1.99	6.5	2.03	6.7	2.07	6.9	2.13	7.1	2.19	
41	5.8	1.84	6.1	1.94	6.3	2.00	6.4	2.04	6.5	2.08	6.7	2.14	6.9	2.20	
43	5.6	1.85	6.0	1.95	6.1	2.01	6.3	2.05	6.4	2.09	6.6	2.15	6.8	2.21	
45	5.5	1.85	5.8	1.96	6.0	2.02	6.1	2.06	6.3	2.10	6.5	2.16	6.6	2.23	
48	5.4	1.86	5.7	1.97	5.9	2.03	6.0	2.07	6.1	2.11	6.3	2.17	6.5	2.24	
50	5.3	1.87	5.6	1.98	5.8	2.04	5.9	2.08	6.0	2.12	6.2	2.19	6.4	2.25	
52	5.2	1.88	5.5	1.99	5.7	2.05	5.8	2.09	5.9	2.13	6.1	2.20	6.2	2.26	
55	5.1	1.89	5.4	2.00	5.6	2.06	5.7	2.10	5.8	2.14	6.0	2.21	6.1	2.27	



Combination (%) (Capacity index)	Outdoor Air temperature (° C DB)	Indoor temperature (° C WB)													
		DB: 20.8, WB: 14		DB: 23.3, WB: 16		DB: 25.8, WB: 18		DB: 27, WB: 19		DB: 28.2, WB: 20		DB: 30.7, WB: 22		DB: 32, WB: 24	
		TC	PI	TC	PI	TC	PI	TC	PI	TC	PI	TC	PI	TC	PI
		kW	kW	kW	kW	kW	kW	kW	kW	kW	kW	kW	kW	kW	kW
50%	-5	3.9	0.65	4.1	0.68	4.2	0.71	4.3	0.72	4.4	0.74	4.5	0.76	4.7	0.78
	-2	3.8	0.66	4.0	0.69	4.1	0.71	4.2	0.73	4.3	0.74	4.4	0.76	4.6	0.79
	0	3.7	0.66	3.9	0.70	4.1	0.72	4.2	0.74	4.2	0.75	4.4	0.77	4.5	0.79
	2	3.7	0.67	3.9	0.71	4.0	0.73	4.1	0.74	4.2	0.76	4.3	0.78	4.4	0.80
	4	3.6	0.68	3.8	0.71	3.9	0.74	4.0	0.75	4.1	0.77	4.2	0.79	4.3	0.81
	6	3.5	0.68	3.7	0.72	3.8	0.74	3.9	0.76	4.0	0.77	4.1	0.80	4.2	0.82
	8	3.5	0.69	3.6	0.73	3.8	0.75	3.8	0.77	3.9	0.78	4.0	0.80	4.1	0.83
	10	4.6	0.91	4.9	0.97	5.0	1.00	5.1	1.02	5.2	1.04	5.4	1.07	5.5	1.10
	12	4.5	0.95	4.8	1.01	4.9	1.04	5.0	1.06	5.1	1.08	5.3	1.11	5.4	1.14
	14	4.4	0.99	4.7	1.05	4.8	1.08	4.9	1.10	5.0	1.12	5.2	1.16	5.3	1.19
	16	4.4	1.03	4.6	1.09	4.7	1.13	4.8	1.15	4.9	1.17	5.1	1.21	5.2	1.24
	18	5.1	1.16	5.3	1.22	5.5	1.26	5.6	1.29	5.7	1.31	5.9	1.35	6.1	1.39
	20	5.0	1.17	5.2	1.24	5.4	1.27	5.5	1.30	5.6	1.33	5.8	1.37	6.0	1.40
	21	4.9	1.18	5.1	1.25	5.3	1.29	5.4	1.31	5.5	1.34	5.7	1.38	5.8	1.42
	23	4.8	1.19	5.0	1.26	5.2	1.30	5.3	1.33	5.4	1.35	5.6	1.39	5.7	1.43
	25	4.7	1.21	4.9	1.27	5.1	1.31	5.2	1.34	5.3	1.37	5.5	1.41	5.6	1.45
	27	5.7	1.50	6.1	1.59	6.3	1.64	6.4	1.67	6.5	1.70	6.7	1.76	6.9	1.81
	29	5.6	1.52	5.9	1.60	6.1	1.65	6.3	1.69	6.4	1.72	6.6	1.77	6.8	1.82
	31	5.5	1.53	5.8	1.62	6.0	1.67	6.1	1.71	6.3	1.74	6.4	1.79	6.6	1.84
	33	5.4	1.55	5.7	1.64	5.9	1.69	6.0	1.72	6.1	1.76	6.3	1.81	6.5	1.86
	35	5.3	1.57	5.6	1.65	5.8	1.71	5.9	1.74	6.0	1.77	6.2	1.83	6.4	1.88
37	5.2	1.57	5.5	1.66	5.7	1.71	5.8	1.75	5.9	1.78	6.1	1.84	6.2	1.89	
39	5.1	1.58	5.4	1.67	5.6	1.72	5.7	1.76	5.8	1.79	5.9	1.85	6.1	1.90	
41	5.0	1.59	5.3	1.68	5.4	1.73	5.6	1.77	5.7	1.80	5.8	1.85	6.0	1.91	
43	4.9	1.60	5.2	1.69	5.3	1.74	5.4	1.78	5.6	1.81	5.7	1.86	5.9	1.92	
45	4.8	1.61	5.1	1.69	5.2	1.75	5.3	1.78	5.4	1.82	5.6	1.87	5.8	1.93	
48	4.7	1.61	5.0	1.70	5.1	1.76	5.2	1.79	5.3	1.83	5.5	1.88	5.6	1.94	
50	4.6	1.62	4.9	1.71	5.0	1.77	5.1	1.80	5.2	1.84	5.4	1.89	5.5	1.95	
52	4.5	1.63	4.8	1.72	4.9	1.77	5.0	1.81	5.1	1.85	5.3	1.90	5.4	1.96	
55	4.4	1.64	4.7	1.73	4.8	1.78	4.9	1.82	5.0	1.86	5.2	1.91	5.3	1.97	

# VNMF Mini VRF 50/60Hz

VNMF003Q0A-G06V125

TC: Total Capacity (kW); PI: Power Input (kW) (Compressor + Outdoor fan motor)

Combination (%) (Capacity index)	Outdoor Air temperature (° C DB)	Indoor temperature (° C WB)													
		DB: 20.8, WB: 14		DB: 23.3, WB: 16		DB: 25.8, WB: 18		DB: 27, WB: 19		DB: 28.2, WB: 20		DB: 30.7, WB: 22		DB: 32, WB: 24	
		TC	PI	TC	PI	TC	PI	TC	PI	TC	PI	TC	PI	TC	PI
		kW	kW	kW	kW	kW	kW	kW	kW	kW	kW	kW	kW	kW	kW
130%	-5	8.8	1.24	9.3	1.31	9.6	1.35	9.8	1.38	10.0	1.41	10.3	1.45	10.6	1.49
	-2	8.6	1.25	9.1	1.32	9.4	1.36	9.6	1.39	9.8	1.42	10.1	1.46	10.4	1.50
	0	8.5	1.27	8.9	1.34	9.2	1.38	9.4	1.41	9.6	1.43	9.9	1.48	10.2	1.52
	2	8.3	1.28	8.8	1.35	9.0	1.39	9.2	1.42	9.4	1.45	9.7	1.49	10.0	1.53
	4	8.1	1.29	8.6	1.36	8.9	1.41	9.0	1.44	9.2	1.46	9.5	1.51	9.8	1.55
	6	8.0	1.30	8.4	1.38	8.7	1.42	8.9	1.45	9.0	1.48	9.3	1.52	9.6	1.57
	8	7.8	1.32	8.3	1.39	8.5	1.44	8.7	1.46	8.9	1.49	9.1	1.54	9.4	1.58
	10	10.5	1.75	11.1	1.85	11.4	1.90	11.6	1.94	11.9	1.98	12.2	2.04	12.6	2.10
	12	10.3	1.82	10.8	1.92	11.2	1.98	11.4	2.02	11.6	2.06	12.0	2.13	12.3	2.19
	14	10.1	1.90	10.6	2.00	11.0	2.07	11.2	2.11	11.4	2.15	11.7	2.21	12.1	2.28
	16	9.9	1.98	10.4	2.09	10.7	2.15	11.0	2.20	11.2	2.24	11.5	2.31	11.8	2.37
	18	11.5	2.22	12.1	2.34	12.5	2.41	12.7	2.46	13.0	2.51	13.4	2.58	13.8	2.66
	20	11.2	2.24	11.9	2.36	12.2	2.44	12.5	2.49	12.7	2.54	13.1	2.61	13.5	2.69
	21	11.0	2.26	11.6	2.39	12.0	2.46	12.2	2.51	12.5	2.56	12.9	2.64	13.2	2.71
	23	10.8	2.28	11.4	2.41	11.8	2.49	12.0	2.54	12.2	2.59	12.6	2.66	13.0	2.74
	25	10.6	2.31	11.2	2.43	11.5	2.51	11.8	2.56	12.0	2.61	12.4	2.69	12.7	2.77
	27	13.0	2.88	13.8	3.04	14.2	3.13	14.5	3.20	14.8	3.26	15.2	3.36	15.6	3.45
	29	12.8	2.91	13.5	3.07	13.9	3.16	14.2	3.23	14.5	3.29	14.9	3.39	15.3	3.49
	31	12.5	2.94	13.2	3.10	13.6	3.20	13.9	3.26	14.2	3.33	14.6	3.42	15.0	3.52
	33	12.3	2.97	13.0	3.13	13.4	3.23	13.6	3.29	13.9	3.36	14.3	3.46	14.7	3.56
35	12.0	3.00	12.7	3.16	13.1	3.26	13.4	3.33	13.6	3.39	14.0	3.49	14.4	3.59	
37	11.8	3.01	12.5	3.18	12.8	3.28	13.1	3.34	13.4	3.41	13.8	3.51	14.2	3.61	
39	11.2	2.95	11.8	3.11	12.2	3.21	12.5	3.28	12.7	3.34	13.1	3.44	13.4	3.54	
41	10.6	2.89	11.2	3.05	11.6	3.15	11.8	3.21	12.1	3.28	12.4	3.37	12.8	3.47	
43	10.1	2.83	10.7	2.99	11.0	3.08	11.2	3.15	11.5	3.21	11.8	3.31	12.1	3.40	
45	9.6	2.75	10.1	2.90	10.5	2.99	10.7	3.05	10.9	3.11	11.2	3.21	11.5	3.30	
48	9.1	2.61	9.6	2.76	9.9	2.84	10.1	2.90	10.3	2.96	10.6	3.05	11.0	3.13	
50	8.7	2.40	9.2	2.54	9.4	2.62	9.6	2.67	9.8	2.72	10.1	2.80	10.4	2.88	
52	8.2	2.21	8.7	2.33	9.0	2.41	9.2	2.46	9.3	2.50	9.6	2.58	9.9	2.65	
55	7.8	2.03	8.3	2.15	8.5	2.21	8.7	2.26	8.9	2.30	9.1	2.37	9.4	2.44	
120%	-5	8.6	1.23	9.1	1.30	9.4	1.34	9.6	1.37	9.8	1.39	10.1	1.43	10.4	1.47
	-2	8.5	1.24	8.9	1.31	9.2	1.35	9.4	1.38	9.6	1.41	9.9	1.45	10.2	1.49
	0	8.3	1.25	8.8	1.32	9.0	1.37	9.2	1.39	9.4	1.42	9.7	1.46	10.0	1.50
	2	8.1	1.27	8.6	1.34	8.9	1.38	9.1	1.41	9.2	1.44	9.5	1.48	9.8	1.52
	4	8.0	1.28	8.4	1.35	8.7	1.39	8.9	1.42	9.1	1.45	9.3	1.49	9.6	1.54
	6	7.8	1.29	8.3	1.36	8.5	1.41	8.7	1.44	8.9	1.46	9.1	1.51	9.4	1.55
	8	7.7	1.31	8.1	1.38	8.4	1.42	8.5	1.45	8.7	1.48	9.0	1.52	9.2	1.57
	10	10.3	1.73	10.9	1.83	11.2	1.89	11.4	1.92	11.6	1.96	12.0	2.02	12.3	2.08
	12	10.1	1.80	10.6	1.90	11.0	1.96	11.2	2.00	11.4	2.04	11.8	2.11	12.1	2.17
	14	9.9	1.88	10.4	1.98	10.8	2.05	11.0	2.09	11.2	2.13	11.5	2.19	11.9	2.26
	16	9.7	1.96	10.2	2.07	10.5	2.13	10.8	2.18	11.0	2.22	11.3	2.28	11.6	2.35
	18	11.3	2.19	11.9	2.32	12.3	2.39	12.5	2.44	12.8	2.49	13.1	2.56	13.5	2.63
	20	11.0	2.22	11.6	2.34	12.0	2.41	12.3	2.46	12.5	2.51	12.9	2.59	13.2	2.66
	21	10.8	2.24	11.4	2.36	11.8	2.44	12.0	2.49	12.3	2.54	12.6	2.61	13.0	2.69
	23	10.6	2.26	11.2	2.39	11.5	2.46	11.8	2.51	12.0	2.56	12.4	2.64	12.7	2.71
	25	10.4	2.28	11.0	2.41	11.3	2.49	11.6	2.54	11.8	2.59	12.1	2.66	12.5	2.74
	27	12.8	2.85	13.5	3.01	13.9	3.10	14.2	3.17	14.5	3.23	14.9	3.32	15.3	3.42
	29	12.5	2.88	13.2	3.04	13.6	3.13	13.9	3.20	14.2	3.26	14.6	3.36	15.0	3.45
	31	12.3	2.91	13.0	3.07	13.4	3.17	13.7	3.23	13.9	3.30	14.3	3.39	14.7	3.49
	33	12.0	2.94	12.7	3.10	13.1	3.20	13.4	3.26	13.7	3.33	14.1	3.43	14.5	3.52
35	11.8	2.97	12.5	3.13	12.9	3.23	13.1	3.30	13.4	3.36	13.8	3.46	14.2	3.56	
37	11.6	2.98	12.2	3.15	12.6	3.25	12.9	3.31	13.1	3.38	13.5	3.48	13.9	3.58	
39	11.0	2.92	11.6	3.08	12.0	3.18	12.2	3.25	12.5	3.31	12.8	3.41	13.2	3.51	
41	10.4	2.86	11.0	3.02	11.4	3.12	11.6	3.18	11.8	3.24	12.2	3.34	12.5	3.44	
43	9.9	2.81	10.5	2.96	10.8	3.06	11.0	3.12	11.2	3.18	11.6	3.27	11.9	3.37	
45	9.4	2.72	10.0	2.87	10.3	2.96	10.5	3.02	10.7	3.08	11.0	3.18	11.3	3.27	
48	9.0	2.59	9.5	2.73	9.8	2.82	10.0	2.87	10.2	2.93	10.5	3.02	10.7	3.10	
50	8.5	2.38	9.0	2.51	9.3	2.59	9.5	2.64	9.6	2.70	9.9	2.78	10.2	2.85	
52	8.1	2.19	8.5	2.31	8.8	2.38	9.0	2.43	9.2	2.48	9.4	2.55	9.7	2.63	
55	7.7	2.01	8.1	2.13	8.4	2.19	8.5	2.24	8.7	2.28	9.0	2.35	9.2	2.42	

Combination (%) (Capacity index)	Outdoor Air temperature (° C DB)	Indoor temperature (° C WB)													
		DB: 20.8, WB: 14		DB: 23.3, WB: 16		DB: 25.8, WB: 18		DB: 27, WB: 19		DB: 28.2, WB: 20		DB: 30.7, WB: 22		DB: 32, WB: 24	
		TC	PI	TC	PI	TC	PI	TC	PI	TC	PI	TC	PI	TC	PI
		kW	kW	kW	kW	kW	kW	kW	kW	kW	kW	kW	kW	kW	kW
110%	-5	8.5	1.22	9.0	1.28	9.2	1.33	9.4	1.35	9.6	1.38	9.9	1.42	10.2	1.46
	-2	8.3	1.23	8.8	1.30	9.1	1.34	9.2	1.37	9.4	1.39	9.7	1.43	10.0	1.48
	0	8.2	1.24	8.6	1.31	8.9	1.35	9.1	1.38	9.2	1.41	9.5	1.45	9.8	1.49
	2	8.0	1.25	8.4	1.32	8.7	1.37	8.9	1.39	9.1	1.42	9.3	1.46	9.6	1.50
	4	7.8	1.27	8.3	1.34	8.5	1.38	8.7	1.41	8.9	1.44	9.1	1.48	9.4	1.52
	6	7.7	1.28	8.1	1.35	8.4	1.39	8.5	1.42	8.7	1.45	9.0	1.49	9.2	1.54
	8	7.5	1.29	8.0	1.36	8.2	1.41	8.4	1.44	8.5	1.46	8.8	1.51	9.0	1.55
	10	10.1	1.72	10.6	1.81	11.0	1.87	11.2	1.91	11.4	1.94	11.8	2.00	12.1	2.06
	12	9.9	1.79	10.4	1.89	10.8	1.95	11.0	1.99	11.2	2.03	11.5	2.08	11.9	2.14
	14	9.7	1.86	10.2	1.96	10.6	2.03	10.8	2.07	11.0	2.11	11.3	2.17	11.6	2.23
	16	9.5	1.94	10.0	2.05	10.3	2.11	10.6	2.15	10.8	2.20	11.1	2.26	11.4	2.33
	18	11.0	2.17	11.7	2.29	12.0	2.37	12.3	2.41	12.5	2.46	12.9	2.53	13.2	2.61
	20	10.8	2.19	11.4	2.32	11.8	2.39	12.0	2.44	12.3	2.49	12.6	2.56	13.0	2.63
	21	10.6	2.22	11.2	2.34	11.6	2.41	11.8	2.46	12.0	2.51	12.4	2.59	12.7	2.66
	23	10.4	2.24	11.0	2.36	11.3	2.44	11.6	2.49	11.8	2.54	12.1	2.61	12.5	2.69
	25	10.2	2.26	10.8	2.39	11.1	2.46	11.3	2.51	11.6	2.56	11.9	2.64	12.2	2.71
	27	12.5	2.82	13.2	2.98	13.7	3.07	13.9	3.14	14.2	3.20	14.6	3.29	15.1	3.39
	29	12.3	2.85	13.0	3.01	13.4	3.10	13.7	3.17	13.9	3.23	14.3	3.33	14.8	3.42
	31	12.1	2.88	12.7	3.04	13.1	3.14	13.4	3.20	13.7	3.26	14.1	3.36	14.5	3.45
	33	11.8	2.91	12.5	3.07	12.9	3.17	13.1	3.23	13.4	3.30	13.8	3.39	14.2	3.49
35	11.6	2.94	12.2	3.10	12.6	3.20	12.9	3.26	13.1	3.33	13.5	3.43	13.9	3.53	
37	11.4	2.95	12.0	3.12	12.4	3.21	12.6	3.28	12.9	3.35	13.2	3.44	13.6	3.54	
39	10.8	2.89	11.4	3.05	11.7	3.15	12.0	3.21	12.2	3.28	12.6	3.38	12.9	3.47	
41	10.2	2.84	10.8	2.99	11.2	3.09	11.4	3.15	11.6	3.21	12.0	3.31	12.3	3.40	
43	9.7	2.78	10.3	2.93	10.6	3.03	10.8	3.09	11.0	3.15	11.4	3.24	11.7	3.33	
45	9.2	2.70	9.8	2.85	10.1	2.93	10.3	2.99	10.5	3.05	10.8	3.14	11.1	3.23	
48	8.8	2.56	9.3	2.70	9.6	2.79	9.8	2.85	10.0	2.90	10.3	2.99	10.5	3.07	
50	8.3	2.36	8.8	2.49	9.1	2.57	9.3	2.62	9.5	2.67	9.7	2.75	10.0	2.83	
52	7.9	2.17	8.4	2.29	8.6	2.36	8.8	2.41	9.0	2.46	9.3	2.53	9.5	2.60	
55	7.5	1.99	8.0	2.10	8.2	2.17	8.4	2.22	8.5	2.26	8.8	2.33	9.0	2.39	
100%	-5	8.2	1.19	8.7	1.26	9.0	1.30	9.2	1.33	9.3	1.35	9.6	1.39	9.9	1.43
	-2	8.1	1.21	8.5	1.27	8.8	1.31	9.0	1.34	9.2	1.37	9.4	1.41	9.7	1.45
	0	7.9	1.22	8.4	1.28	8.6	1.33	8.8	1.35	9.0	1.38	9.2	1.42	9.5	1.46
	2	7.8	1.23	8.2	1.30	8.4	1.34	8.6	1.37	8.8	1.39	9.1	1.43	9.3	1.48
	4	7.6	1.24	8.0	1.31	8.3	1.35	8.5	1.38	8.6	1.41	8.9	1.45	9.1	1.49
	6	7.5	1.25	7.9	1.32	8.1	1.37	8.3	1.39	8.5	1.42	8.7	1.46	9.0	1.51
	8	7.3	1.27	7.7	1.34	8.0	1.38	8.1	1.41	8.3	1.44	8.5	1.48	8.8	1.52
	10	9.8	1.68	10.3	1.78	10.7	1.83	10.9	1.87	11.1	1.91	11.4	1.96	11.7	2.02
	12	9.6	1.75	10.1	1.85	10.5	1.91	10.7	1.95	10.9	1.99	11.2	2.04	11.5	2.10
	14	9.4	1.82	9.9	1.93	10.2	1.99	10.5	2.03	10.7	2.07	11.0	2.13	11.3	2.19
	16	9.2	1.90	9.7	2.01	10.0	2.07	10.3	2.11	10.5	2.15	10.8	2.22	11.1	2.28
	18	10.7	2.13	11.3	2.25	11.7	2.32	11.9	2.37	12.1	2.41	12.5	2.49	12.9	2.56
	20	10.5	2.15	11.1	2.27	11.4	2.34	11.7	2.39	11.9	2.44	12.3	2.51	12.6	2.58
	21	10.3	2.17	10.9	2.29	11.2	2.37	11.4	2.41	11.7	2.46	12.0	2.54	12.4	2.61
	23	10.1	2.20	10.7	2.32	11.0	2.39	11.2	2.44	11.4	2.49	11.8	2.56	12.1	2.63
	25	9.9	2.22	10.5	2.34	10.8	2.41	11.0	2.46	11.2	2.51	11.6	2.59	11.9	2.66
	27	12.2	2.77	12.9	2.92	13.3	3.01	13.5	3.07	13.8	3.14	14.2	3.23	14.6	3.32
	29	11.9	2.79	12.6	2.95	13.0	3.04	13.3	3.10	13.5	3.17	13.9	3.26	14.3	3.35
	31	11.7	2.82	12.4	2.98	12.7	3.07	13.0	3.14	13.3	3.20	13.7	3.29	14.0	3.39
	33	11.5	2.85	12.1	3.01	12.5	3.10	12.8	3.17	13.0	3.23	13.4	3.33	13.8	3.42
35	11.3	2.88	11.9	3.04	12.3	3.14	12.5	3.20	12.8	3.26	13.1	3.36	13.5	3.46	
37	11.0	2.89	11.6	3.06	12.0	3.15	12.3	3.25	12.5	3.28	12.9	3.38	13.2	3.47	
39	10.5	2.84	11.1	2.99	11.4	3.09	12.0	3.30	11.9	3.21	12.2	3.31	12.6	3.40	
41	10.0	2.78	10.5	2.93	10.8	3.03	11.8	3.36	11.3	3.15	11.6	3.24	11.9	3.34	
43	9.5	2.72	10.0	2.88	10.3	2.97	11.5	3.41	10.7	3.09	11.0	3.18	11.3	3.27	
45	9.0	2.64	9.5	2.79	9.8	2.88	11.3	3.46	10.2	2.99	10.5	3.08	10.8	3.17	
48	8.5	2.51	9.0	2.65	9.3	2.73	11.1	3.52	9.7	2.85	10.0	2.93	10.2	3.01	
50	8.1	2.31	8.6	2.44	8.8	2.51	10.9	3.58	9.2	2.62	9.5	2.69	9.7	2.77	
52	7.7	2.12	8.1	2.24	8.4	2.31	10.6	3.63	8.7	2.41	9.0	2.48	9.2	2.55	
55	7.3	1.95	7.7	2.06	8.0	2.13	10.4	3.69	8.3	2.22	8.5	2.28	8.8	2.35	

# VNMF Mini VRF 50/60Hz

Combination (%) (Capacity index)	Outdoor Air temperature (° C DB)	Indoor temperature (° C WB)													
		DB: 20.8, WB: 14		DB: 23.3, WB: 16		DB: 25.8, WB: 18		DB: 27, WB: 19		DB: 28.2, WB: 20		DB: 30.7, WB: 22		DB: 32, WB: 24	
		TC	PI	TC	PI	TC	PI	TC	PI	TC	PI	TC	PI	TC	PI
		kW	kW	kW	kW	kW	kW	kW	kW	kW	kW	kW	kW	kW	kW
90%	-5	7.8	1.12	8.3	1.18	8.5	1.22	8.7	1.25	8.9	1.27	9.1	1.31	9.4	1.35
	-2	7.7	1.13	8.1	1.20	8.4	1.23	8.5	1.26	8.7	1.28	8.9	1.32	9.2	1.36
	0	7.5	1.14	7.9	1.21	8.2	1.25	8.4	1.27	8.5	1.30	8.8	1.33	9.0	1.37
	2	7.4	1.16	7.8	1.22	8.0	1.26	8.2	1.28	8.4	1.31	8.6	1.35	8.8	1.39
	4	7.2	1.17	7.6	1.23	7.9	1.27	8.0	1.30	8.2	1.32	8.4	1.36	8.7	1.40
	6	7.1	1.18	7.5	1.24	7.7	1.28	7.9	1.31	8.0	1.34	8.3	1.38	8.5	1.42
	8	6.9	1.19	7.3	1.26	7.6	1.30	7.7	1.32	7.9	1.35	8.1	1.39	8.3	1.43
	10	9.3	1.58	9.8	1.67	10.1	1.72	10.3	1.76	10.5	1.79	10.9	1.84	11.2	1.90
	12	9.1	1.65	9.6	1.74	9.9	1.79	10.1	1.83	10.3	1.87	10.6	1.92	10.9	1.98
	14	8.9	1.72	9.4	1.81	9.7	1.87	9.9	1.91	10.1	1.94	10.4	2.00	10.7	2.06
	16	8.8	1.79	9.3	1.89	9.5	1.95	9.7	1.99	9.9	2.02	10.2	2.08	10.5	2.14
	18	10.2	2.00	10.7	2.11	11.1	2.18	11.3	2.22	11.5	2.27	11.9	2.34	12.2	2.40
	20	10.0	2.02	10.5	2.13	10.9	2.20	11.1	2.25	11.3	2.29	11.6	2.36	12.0	2.43
	21	9.8	2.04	10.3	2.16	10.7	2.22	10.9	2.27	11.1	2.32	11.4	2.38	11.7	2.45
	23	9.6	2.06	10.1	2.18	10.4	2.25	10.7	2.29	10.9	2.34	11.2	2.41	11.5	2.48
	25	9.4	2.08	9.9	2.20	10.2	2.27	10.5	2.32	10.7	2.36	11.0	2.43	11.3	2.50
	27	11.6	2.60	12.2	2.74	12.6	2.83	12.9	2.89	13.1	2.95	13.5	3.03	13.9	3.12
	29	11.3	2.63	12.0	2.77	12.3	2.86	12.6	2.92	12.9	2.98	13.2	3.06	13.6	3.15
	31	11.1	2.65	11.7	2.80	12.1	2.89	12.4	2.95	12.6	3.01	13.0	3.10	13.3	3.18
	33	10.9	2.68	11.5	2.83	11.9	2.92	12.1	2.98	12.4	3.04	12.7	3.13	13.1	3.22
35	10.7	2.71	11.3	2.86	11.6	2.95	11.9	3.01	12.1	3.07	12.5	3.16	12.8	3.25	
37	10.5	2.72	11.1	2.87	11.4	2.96	11.6	3.02	11.9	3.08	12.2	3.17	12.6	3.26	
39	10.0	2.67	10.5	2.81	10.8	2.90	11.1	2.96	11.3	3.02	11.6	3.11	11.9	3.20	
41	9.5	2.61	10.0	2.76	10.3	2.85	10.5	2.90	10.7	2.96	11.0	3.05	11.3	3.14	
43	9.0	2.56	9.5	2.70	9.8	2.79	10.0	2.85	10.2	2.90	10.5	2.99	10.8	3.07	
45	8.5	2.48	9.0	2.62	9.3	2.70	9.5	2.76	9.7	2.82	10.0	2.90	10.2	2.98	
48	8.1	2.36	8.6	2.49	8.8	2.57	9.0	2.62	9.2	2.67	9.5	2.75	9.7	2.83	
50	7.7	2.17	8.1	2.29	8.4	2.36	8.6	2.41	8.7	2.46	9.0	2.53	9.2	2.61	
52	7.3	2.00	7.7	2.11	8.0	2.17	8.1	2.22	8.3	2.26	8.5	2.33	8.8	2.40	
55	6.9	1.84	7.3	1.94	7.6	2.00	7.7	2.04	7.9	2.08	8.1	2.14	8.3	2.20	
80%	-5	7.1	1.01	7.5	1.07	7.7	1.10	7.9	1.13	8.0	1.15	8.3	1.18	8.5	1.22
	-2	6.9	1.02	7.3	1.08	7.6	1.12	7.7	1.14	7.9	1.16	8.1	1.20	8.3	1.23
	0	6.8	1.03	7.2	1.09	7.4	1.13	7.6	1.15	7.7	1.17	7.9	1.21	8.2	1.24
	2	6.7	1.05	7.0	1.10	7.3	1.14	7.4	1.16	7.6	1.18	7.8	1.22	8.0	1.25
	4	6.5	1.06	6.9	1.11	7.1	1.15	7.3	1.17	7.4	1.20	7.6	1.23	7.9	1.27
	6	6.4	1.07	6.8	1.13	7.0	1.16	7.1	1.18	7.3	1.21	7.5	1.24	7.7	1.28
	8	6.3	1.08	6.6	1.14	6.8	1.17	7.0	1.20	7.1	1.22	7.3	1.26	7.5	1.29
	10	8.4	1.43	8.9	1.51	9.2	1.56	9.4	1.59	9.5	1.62	9.8	1.67	10.1	1.72
	12	8.3	1.49	8.7	1.57	9.0	1.62	9.2	1.65	9.4	1.69	9.6	1.74	9.9	1.79
	14	8.1	1.55	8.5	1.64	8.8	1.69	9.0	1.72	9.2	1.76	9.4	1.81	9.7	1.86
	16	7.9	1.62	8.4	1.71	8.6	1.76	8.8	1.80	9.0	1.83	9.3	1.88	9.5	1.94
	18	9.2	1.81	9.7	1.91	10.0	1.97	10.2	2.01	10.4	2.05	10.8	2.11	11.1	2.17
	20	9.0	1.83	9.5	1.93	9.8	1.99	10.0	2.03	10.2	2.07	10.5	2.13	10.8	2.19
	21	8.9	1.85	9.4	1.95	9.6	2.01	9.8	2.05	10.0	2.09	10.3	2.16	10.6	2.22
	23	8.7	1.87	9.2	1.97	9.5	2.03	9.6	2.07	9.8	2.11	10.1	2.18	10.4	2.24
	25	8.5	1.88	9.0	1.99	9.3	2.05	9.5	2.09	9.6	2.14	9.9	2.20	10.2	2.26
	27	10.5	2.35	11.1	2.48	11.4	2.56	11.6	2.61	11.9	2.67	12.2	2.74	12.6	2.82
	29	10.3	2.38	10.8	2.51	11.2	2.59	11.4	2.64	11.6	2.69	12.0	2.77	12.3	2.85
	31	10.1	2.40	10.6	2.53	11.0	2.61	11.2	2.67	11.4	2.72	11.7	2.80	12.1	2.88
	33	9.9	2.42	10.4	2.56	10.7	2.64	11.0	2.69	11.2	2.75	11.5	2.83	11.8	2.91
35	9.7	2.45	10.2	2.58	10.5	2.67	10.8	2.72	11.0	2.77	11.3	2.86	11.6	2.94	
37	9.5	2.46	10.0	2.60	10.3	2.68	10.5	2.73	10.7	2.79	11.1	2.87	11.4	2.95	
39	9.0	2.41	9.5	2.54	9.8	2.63	10.0	2.68	10.2	2.73	10.5	2.81	10.8	2.89	
41	8.6	2.36	9.0	2.49	9.3	2.57	9.5	2.63	9.7	2.68	10.0	2.76	10.3	2.84	
43	8.1	2.32	8.6	2.44	8.9	2.52	9.0	2.57	9.2	2.62	9.5	2.70	9.8	2.78	
45	7.7	2.25	8.2	2.37	8.4	2.45	8.6	2.50	8.8	2.55	9.0	2.62	9.3	2.70	
48	7.3	2.13	7.7	2.25	8.0	2.32	8.2	2.37	8.3	2.42	8.6	2.49	8.8	2.56	
50	7.0	1.96	7.4	2.07	7.6	2.14	7.7	2.18	7.9	2.22	8.1	2.29	8.4	2.36	
52	6.6	1.81	7.0	1.91	7.2	1.97	7.4	2.01	7.5	2.05	7.7	2.11	7.9	2.17	
55	6.3	1.66	6.6	1.75	6.8	1.81	7.0	1.85	7.1	1.88	7.3	1.94	7.5	1.99	

Combination (%) (Capacity index)	Outdoor Air temperature (° C DB)	Indoor temperature (° C WB)													
		DB: 20.8, WB: 14		DB: 23.3, WB: 16		DB: 25.8, WB: 18		DB: 27, WB: 19		DB: 28.2, WB: 20		DB: 30.7, WB: 22		DB: 32, WB: 24	
		TC	PI	TC	PI	TC	PI	TC	PI	TC	PI	TC	PI	TC	PI
		kW	kW	kW	kW	kW	kW	kW	kW	kW	kW	kW	kW	kW	kW
70%	-5	6.3	0.91	6.7	0.96	6.9	0.99	7.0	1.01	7.2	1.03	7.4	1.06	7.6	1.09
	-2	6.2	0.92	6.6	0.97	6.8	1.00	6.9	1.02	7.0	1.04	7.3	1.07	7.5	1.10
	0	6.1	0.93	6.4	0.98	6.6	1.01	6.8	1.03	6.9	1.05	7.1	1.08	7.3	1.11
	2	6.0	0.93	6.3	0.99	6.5	1.02	6.6	1.04	6.8	1.06	7.0	1.09	7.2	1.12
	4	5.9	0.94	6.2	1.00	6.4	1.03	6.5	1.05	6.6	1.07	6.8	1.10	7.0	1.13
	6	5.7	0.95	6.1	1.01	6.3	1.04	6.4	1.06	6.5	1.08	6.7	1.11	6.9	1.14
	8	5.6	0.96	5.9	1.02	6.1	1.05	6.3	1.07	6.4	1.09	6.6	1.12	6.8	1.16
	10	7.5	1.28	8.0	1.35	8.2	1.39	8.4	1.42	8.5	1.45	8.8	1.49	9.0	1.53
	12	7.4	1.33	7.8	1.41	8.0	1.45	8.2	1.48	8.4	1.51	8.6	1.55	8.9	1.60
	14	7.2	1.39	7.6	1.46	7.9	1.51	8.1	1.54	8.2	1.57	8.5	1.62	8.7	1.66
	16	7.1	1.44	7.5	1.52	7.7	1.57	7.9	1.61	8.1	1.64	8.3	1.69	8.5	1.73
	18	8.3	1.62	8.7	1.71	9.0	1.76	9.2	1.80	9.4	1.83	9.6	1.89	9.9	1.94
	20	8.1	1.64	8.5	1.73	8.8	1.78	9.0	1.82	9.2	1.85	9.4	1.91	9.7	1.96
	21	7.9	1.65	8.4	1.74	8.6	1.80	8.8	1.84	9.0	1.87	9.3	1.93	9.5	1.98
	23	7.8	1.67	8.2	1.76	8.5	1.82	8.6	1.85	8.8	1.89	9.1	1.95	9.3	2.00
	25	7.6	1.69	8.0	1.78	8.3	1.84	8.5	1.87	8.6	1.91	8.9	1.97	9.1	2.02
	27	9.4	2.10	9.9	2.22	10.2	2.29	10.4	2.34	10.6	2.38	10.9	2.45	11.3	2.52
	29	9.2	2.12	9.7	2.24	10.0	2.31	10.2	2.36	10.4	2.41	10.7	2.48	11.0	2.55
	31	9.0	2.15	9.5	2.26	9.8	2.34	10.0	2.38	10.2	2.43	10.5	2.50	10.8	2.57
	33	8.8	2.17	9.3	2.29	9.6	2.36	9.8	2.41	10.0	2.46	10.3	2.53	10.6	2.60
35	8.7	2.19	9.1	2.31	9.4	2.38	9.6	2.43	9.8	2.48	10.1	2.55	10.4	2.63	
37	8.5	2.20	9.0	2.32	9.2	2.40	9.4	2.44	9.6	2.49	9.9	2.57	10.2	2.64	
39	8.3	2.21	8.8	2.33	9.1	2.41	9.2	2.46	9.4	2.51	9.7	2.58	10.0	2.65	
41	8.2	2.22	8.6	2.35	8.9	2.42	9.1	2.47	9.2	2.52	9.5	2.59	9.8	2.67	
43	8.0	2.23	8.4	2.36	8.7	2.43	8.9	2.48	9.1	2.53	9.3	2.61	9.6	2.68	
45	7.8	2.24	8.3	2.37	8.5	2.44	8.7	2.49	8.9	2.54	9.1	2.62	9.4	2.69	
48	7.7	2.26	8.1	2.38	8.4	2.46	8.5	2.51	8.7	2.56	9.0	2.63	9.2	2.71	
50	7.5	2.27	7.9	2.39	8.2	2.47	8.4	2.52	8.5	2.57	8.8	2.64	9.0	2.72	
52	7.4	2.28	7.8	2.40	8.0	2.48	8.2	2.53	8.4	2.58	8.6	2.66	8.8	2.73	
55	7.2	2.29	7.6	2.42	7.9	2.49	8.0	2.54	8.2	2.59	8.4	2.67	8.7	2.75	
60%	-5	5.6	0.80	5.9	0.84	6.1	0.87	6.2	0.89	6.3	0.91	6.5	0.93	6.7	0.96
	-2	5.5	0.81	5.8	0.85	6.0	0.88	6.1	0.90	6.2	0.92	6.4	0.94	6.6	0.97
	0	5.4	0.82	5.7	0.86	5.9	0.89	6.0	0.91	6.1	0.92	6.3	0.95	6.5	0.98
	2	5.3	0.82	5.6	0.87	5.7	0.90	5.9	0.92	6.0	0.93	6.2	0.96	6.3	0.99
	4	5.2	0.83	5.5	0.88	5.6	0.91	5.7	0.92	5.9	0.94	6.0	0.97	6.2	1.00
	6	5.1	0.84	5.4	0.89	5.5	0.92	5.6	0.93	5.7	0.95	5.9	0.98	6.1	1.01
	8	5.0	0.85	5.2	0.90	5.4	0.92	5.5	0.94	5.6	0.96	5.8	0.99	6.0	1.02
	10	6.7	1.13	7.0	1.19	7.2	1.23	7.4	1.25	7.5	1.28	7.8	1.31	8.0	1.35
	12	6.5	1.17	6.9	1.24	7.1	1.28	7.3	1.30	7.4	1.33	7.6	1.37	7.8	1.41
	14	6.4	1.22	6.8	1.29	7.0	1.33	7.1	1.36	7.3	1.39	7.5	1.43	7.7	1.47
	16	6.3	1.27	6.6	1.34	6.8	1.39	7.0	1.42	7.1	1.44	7.3	1.49	7.5	1.53
	18	7.3	1.43	7.7	1.51	7.9	1.55	8.1	1.59	8.3	1.62	8.5	1.67	8.7	1.71
	20	7.1	1.44	7.5	1.52	7.8	1.57	7.9	1.60	8.1	1.63	8.3	1.68	8.6	1.73
	21	7.0	1.46	7.4	1.54	7.6	1.59	7.8	1.62	7.9	1.65	8.2	1.70	8.4	1.75
	23	6.9	1.47	7.2	1.55	7.5	1.60	7.6	1.63	7.8	1.67	8.0	1.72	8.2	1.77
	25	6.7	1.49	7.1	1.57	7.3	1.62	7.5	1.65	7.6	1.68	7.9	1.73	8.1	1.78
	27	8.3	1.85	8.7	1.96	9.0	2.02	9.2	2.06	9.4	2.10	9.7	2.16	9.9	2.22
	29	8.1	1.87	8.6	1.98	8.8	2.04	9.0	2.08	9.2	2.12	9.5	2.18	9.7	2.25
	31	8.0	1.89	8.4	2.00	8.7	2.06	8.8	2.10	9.0	2.14	9.3	2.21	9.6	2.27
	33	7.8	1.91	8.2	2.02	8.5	2.08	8.7	2.12	8.8	2.17	9.1	2.23	9.4	2.29
35	7.7	1.93	8.1	2.04	8.3	2.10	8.5	2.14	8.7	2.19	8.9	2.25	9.2	2.32	
37	7.5	1.94	7.9	2.05	8.2	2.11	8.3	2.15	8.5	2.20	8.7	2.26	9.0	2.33	
39	7.3	1.95	7.8	2.06	8.0	2.12	8.2	2.17	8.3	2.21	8.6	2.27	8.8	2.34	
41	7.2	1.96	7.6	2.07	7.8	2.13	8.0	2.18	8.2	2.22	8.4	2.29	8.6	2.35	
43	7.1	1.97	7.4	2.08	7.7	2.14	7.8	2.19	8.0	2.23	8.2	2.30	8.5	2.36	
45	6.9	1.98	7.3	2.09	7.5	2.15	7.7	2.20	7.8	2.24	8.1	2.31	8.3	2.37	
48	6.8	1.99	7.2	2.10	7.4	2.16	7.5	2.21	7.7	2.25	7.9	2.32	8.1	2.39	
50	6.6	2.00	7.0	2.11	7.2	2.18	7.4	2.22	7.5	2.26	7.7	2.33	8.0	2.40	
52	6.5	2.01	6.9	2.12	7.1	2.19	7.2	2.23	7.4	2.28	7.6	2.34	7.8	2.41	
55	6.4	2.02	6.7	2.13	6.9	2.20	7.1	2.24	7.2	2.29	7.4	2.35	7.7	2.42	

# VNMF Mini VRF 50/60Hz

Combination (%) (Capacity index)	Outdoor Air temperature (° C DB)	Indoor temperature (° C WB)													
		DB: 20.8, WB: 14		DB: 23.3, WB: 16		DB: 25.8, WB: 18		DB: 27, WB: 19		DB: 28.2, WB: 20		DB: 30.7, WB: 22		DB: 32, WB: 24	
		TC	PI	TC	PI	TC	PI	TC	PI	TC	PI	TC	PI	TC	PI
		kW	kW	kW	kW	kW	kW	kW	kW	kW	kW	kW	kW	kW	kW
50%	-5	4.9	0.69	5.1	0.73	5.3	0.75	5.4	0.77	5.5	0.78	5.7	0.81	5.8	0.83
	-2	4.8	0.70	5.0	0.74	5.2	0.76	5.3	0.78	5.4	0.79	5.6	0.82	5.7	0.84
	0	4.7	0.71	4.9	0.75	5.1	0.77	5.2	0.78	5.3	0.80	5.4	0.82	5.6	0.85
	2	4.6	0.71	4.8	0.75	5.0	0.78	5.1	0.79	5.2	0.81	5.3	0.83	5.5	0.86
	4	4.5	0.72	4.7	0.76	4.9	0.78	5.0	0.80	5.1	0.82	5.2	0.84	5.4	0.86
	6	4.4	0.73	4.6	0.77	4.8	0.79	4.9	0.81	5.0	0.82	5.1	0.85	5.3	0.87
	8	4.3	0.73	4.6	0.78	4.7	0.80	4.8	0.82	4.9	0.83	5.0	0.86	5.2	0.88
	10	5.8	0.98	6.1	1.03	6.3	1.06	6.4	1.08	6.5	1.11	6.7	1.14	6.9	1.17
	12	5.7	1.02	6.0	1.07	6.2	1.11	6.3	1.13	6.4	1.15	6.6	1.19	6.8	1.22
	14	5.6	1.06	5.9	1.12	6.0	1.15	6.2	1.18	6.3	1.20	6.5	1.23	6.7	1.27
	16	5.4	1.10	5.7	1.16	5.9	1.20	6.0	1.22	6.2	1.25	6.3	1.29	6.5	1.32
	18	6.3	1.24	6.7	1.30	6.9	1.35	7.0	1.37	7.2	1.40	7.4	1.44	7.6	1.48
	20	6.2	1.25	6.5	1.32	6.7	1.36	6.9	1.39	7.0	1.41	7.2	1.46	7.4	1.50
	21	6.1	1.26	6.4	1.33	6.6	1.37	6.8	1.40	6.9	1.43	7.1	1.47	7.3	1.51
	23	6.0	1.27	6.3	1.34	6.5	1.39	6.6	1.41	6.8	1.44	7.0	1.49	7.1	1.53
	25	5.8	1.29	6.2	1.36	6.4	1.40	6.5	1.43	6.6	1.46	6.8	1.50	7.0	1.54
	27	7.2	1.60	7.6	1.69	7.8	1.75	8.0	1.78	8.1	1.82	8.4	1.87	8.6	1.93
	29	7.0	1.62	7.4	1.71	7.7	1.76	7.8	1.80	8.0	1.84	8.2	1.89	8.5	1.94
	31	6.9	1.64	7.3	1.73	7.5	1.78	7.7	1.82	7.8	1.86	8.1	1.91	8.3	1.96
	33	6.8	1.65	7.1	1.75	7.4	1.80	7.5	1.84	7.7	1.87	7.9	1.93	8.1	1.98
35	6.6	1.67	7.0	1.76	7.2	1.82	7.4	1.86	7.5	1.89	7.7	1.95	8.0	2.00	
37	6.5	1.68	6.9	1.77	7.1	1.83	7.2	1.87	7.4	1.90	7.6	1.96	7.8	2.01	
39	6.4	1.69	6.7	1.78	6.9	1.84	7.1	1.87	7.2	1.91	7.4	1.97	7.6	2.02	
41	6.2	1.70	6.6	1.79	6.8	1.85	6.9	1.88	7.1	1.92	7.3	1.98	7.5	2.03	
43	6.1	1.70	6.5	1.80	6.7	1.86	6.8	1.89	6.9	1.93	7.1	1.99	7.3	2.04	
45	6.0	1.71	6.3	1.81	6.5	1.86	6.7	1.90	6.8	1.94	7.0	2.00	7.2	2.06	
48	5.9	1.72	6.2	1.82	6.4	1.87	6.5	1.91	6.7	1.95	6.9	2.01	7.1	2.07	
50	5.8	1.73	6.1	1.83	6.3	1.88	6.4	1.92	6.5	1.96	6.7	2.02	6.9	2.08	
52	5.6	1.74	6.0	1.83	6.1	1.89	6.3	1.93	6.4	1.97	6.6	2.03	6.8	2.09	
55	5.5	1.75	5.8	1.84	6.0	1.90	6.1	1.94	6.3	1.98	6.5	2.04	6.6	2.10	

VNMF004Q0A-G07V140

TC: Total Capacity (kW); PI: Power Input (kW) (Compressor + Outdoor fan motor)

Combination (%) (Capacity index)	Outdoor Air temperature (° C DB)	Indoor temperature (° C WB)													
		DB: 20.8, WB: 14		DB: 23.3, WB: 16		DB: 25.8, WB: 18		DB: 27, WB: 19		DB: 28.2, WB: 20		DB: 30.7, WB: 22		DB: 32, WB: 24	
		TC kW	PI kW	TC kW	PI kW	TC kW	PI kW	TC kW	PI kW	TC kW	PI kW	TC kW	PI kW	TC kW	PI kW
130%	-5	9.9	1.45	10.4	1.53	10.7	1.58	11.0	1.62	11.2	1.65	11.5	1.70	11.8	1.74
	-2	9.7	1.47	10.2	1.55	10.5	1.60	10.8	1.63	11.0	1.66	11.3	1.71	11.6	1.76
	0	9.5	1.48	10.0	1.57	10.3	1.62	10.5	1.65	10.8	1.68	11.1	1.73	11.4	1.78
	2	9.3	1.50	9.8	1.58	10.1	1.63	10.3	1.67	10.5	1.70	10.8	1.75	11.2	1.80
	4	9.1	1.51	9.6	1.60	9.9	1.65	10.1	1.68	10.3	1.72	10.6	1.77	10.9	1.82
	6	8.9	1.53	9.4	1.61	9.7	1.66	9.9	1.70	10.1	1.73	10.4	1.78	10.7	1.83
	8	8.8	1.54	9.3	1.63	9.5	1.68	9.7	1.72	9.9	1.75	10.2	1.80	10.5	1.85
	10	11.7	2.05	12.4	2.16	12.8	2.23	13.0	2.28	13.3	2.32	13.7	2.39	14.1	2.46
	12	11.5	2.13	12.1	2.25	12.5	2.32	12.8	2.37	13.0	2.42	13.4	2.49	13.8	2.56
	14	11.3	2.22	11.9	2.35	12.3	2.42	12.5	2.47	12.8	2.52	13.2	2.59	13.5	2.67
	16	11.1	2.32	11.7	2.45	12.0	2.52	12.3	2.57	12.5	2.63	12.9	2.70	13.3	2.78
	18	12.8	2.60	13.6	2.74	14.0	2.83	14.3	2.88	14.6	2.94	15.0	3.03	15.4	3.12
	20	12.6	2.62	13.3	2.77	13.7	2.86	14.0	2.91	14.3	2.97	14.7	3.06	15.1	3.15
	21	12.3	2.65	13.0	2.80	13.4	2.88	13.7	2.94	14.0	3.00	14.4	3.09	14.8	3.18
	23	12.1	2.68	12.8	2.82	13.2	2.91	13.4	2.97	13.7	3.03	14.1	3.12	14.5	3.21
	25	11.9	2.70	12.5	2.85	12.9	2.94	13.2	3.00	13.4	3.06	13.8	3.15	14.2	3.24
	27	14.6	3.37	15.4	3.56	15.9	3.67	16.2	3.75	16.5	3.82	17.0	3.93	17.5	4.05
	29	14.3	3.41	15.1	3.59	15.6	3.71	15.9	3.78	16.2	3.86	16.7	3.97	17.2	4.09
	31	14.0	3.44	14.8	3.63	15.3	3.75	15.6	3.82	15.9	3.90	16.4	4.01	16.8	4.13
	33	13.8	3.47	14.5	3.67	15.0	3.78	15.3	3.86	15.6	3.94	16.0	4.05	16.5	4.17
35	13.5	3.51	14.2	3.71	14.7	3.82	15.0	3.90	15.3	3.98	15.7	4.10	16.2	4.21	
37	13.2	3.53	13.9	3.72	14.4	3.84	14.7	3.92	15.0	4.00	15.4	4.12	15.9	4.23	
39	12.6	3.46	13.2	3.65	13.7	3.76	13.9	3.84	14.2	3.92	14.6	4.03	15.1	4.15	
41	11.9	3.39	12.6	3.58	13.0	3.69	13.2	3.76	13.5	3.84	13.9	3.95	14.3	4.07	
43	11.3	3.32	12.0	3.50	12.3	3.62	12.6	3.69	12.8	3.76	13.2	3.87	13.6	3.98	
45	10.8	3.22	11.4	3.40	11.7	3.51	12.0	3.58	12.2	3.65	12.6	3.76	12.9	3.86	
48	10.2	3.06	10.8	3.23	11.1	3.33	11.4	3.40	11.6	3.47	11.9	3.57	12.3	3.67	
50	9.7	2.81	10.3	2.97	10.6	3.06	10.8	3.13	11.0	3.19	11.3	3.28	11.7	3.38	
52	9.2	2.59	9.7	2.73	10.0	2.82	10.3	2.88	10.5	2.93	10.8	3.02	11.1	3.11	
55	8.8	2.38	9.3	2.51	9.5	2.59	9.7	2.65	9.9	2.70	10.2	2.78	10.5	2.86	
120%	-5	9.7	1.44	10.2	1.52	10.5	1.57	10.8	1.60	11.0	1.63	11.3	1.68	11.6	1.73
	-2	9.5	1.45	10.0	1.54	10.3	1.58	10.5	1.62	10.8	1.65	11.1	1.70	11.4	1.75
	0	9.3	1.47	9.8	1.55	10.1	1.60	10.3	1.63	10.5	1.67	10.9	1.71	11.2	1.76
	2	9.1	1.48	9.6	1.57	9.9	1.62	10.1	1.65	10.3	1.68	10.6	1.73	11.0	1.78
	4	8.9	1.50	9.4	1.58	9.7	1.63	9.9	1.67	10.1	1.70	10.4	1.75	10.7	1.80
	6	8.8	1.51	9.3	1.60	9.6	1.65	9.7	1.68	9.9	1.72	10.2	1.77	10.5	1.82
	8	8.6	1.53	9.1	1.61	9.4	1.67	9.6	1.70	9.7	1.73	10.0	1.78	10.3	1.84
	10	11.5	2.03	12.2	2.14	12.5	2.21	12.8	2.26	13.0	2.30	13.4	2.37	13.8	2.44
	12	11.3	2.11	11.9	2.23	12.3	2.30	12.5	2.35	12.8	2.40	13.2	2.47	13.5	2.54
	14	11.1	2.20	11.7	2.32	12.0	2.40	12.3	2.45	12.5	2.50	12.9	2.57	13.3	2.64
	16	10.8	2.29	11.5	2.42	11.8	2.50	12.1	2.55	12.3	2.60	12.7	2.68	13.0	2.75
	18	12.6	2.57	13.3	2.71	13.7	2.80	14.0	2.86	14.3	2.91	14.7	3.00	15.1	3.09
	20	12.4	2.60	13.0	2.74	13.5	2.83	13.7	2.89	14.0	2.94	14.4	3.03	14.8	3.12
	21	12.1	2.62	12.8	2.77	13.2	2.86	13.5	2.91	13.7	2.97	14.1	3.06	14.5	3.15
	23	11.9	2.65	12.5	2.80	12.9	2.89	13.2	2.94	13.5	3.00	13.9	3.09	14.3	3.18
	25	11.6	2.68	12.3	2.83	12.7	2.91	12.9	2.97	13.2	3.03	13.6	3.12	14.0	3.21
	27	14.3	3.34	15.1	3.52	15.6	3.64	15.9	3.71	16.2	3.78	16.7	3.90	17.2	4.01
	29	14.0	3.37	14.8	3.56	15.3	3.67	15.6	3.75	15.9	3.82	16.4	3.94	16.8	4.05
	31	13.8	3.41	14.5	3.60	15.0	3.71	15.3	3.79	15.6	3.86	16.1	3.97	16.5	4.09
	33	13.5	3.44	14.2	3.63	14.7	3.75	15.0	3.82	15.3	3.90	15.7	4.02	16.2	4.13
35	13.2	3.48	14.0	3.67	14.4	3.79	14.7	3.86	15.0	3.94	15.4	4.06	15.9	4.17	
37	13.0	3.49	13.7	3.69	14.1	3.80	14.4	3.88	14.7	3.96	15.1	4.08	15.6	4.19	
39	12.3	3.42	13.0	3.61	13.4	3.73	13.7	3.80	14.0	3.88	14.4	3.99	14.8	4.11	
41	11.7	3.36	12.4	3.54	12.7	3.65	13.0	3.73	13.3	3.80	13.7	3.91	14.0	4.03	
43	11.1	3.29	11.7	3.47	12.1	3.58	12.4	3.65	12.6	3.73	13.0	3.84	13.3	3.95	
45	10.6	3.19	11.1	3.37	11.5	3.47	11.7	3.54	12.0	3.61	12.3	3.72	12.7	3.83	
48	10.0	3.03	10.6	3.20	10.9	3.30	11.1	3.37	11.4	3.43	11.7	3.54	12.0	3.64	
50	9.5	2.79	10.1	2.94	10.4	3.04	10.6	3.10	10.8	3.16	11.1	3.25	11.4	3.35	
52	9.1	2.56	9.6	2.71	9.9	2.79	10.1	2.85	10.3	2.91	10.6	2.99	10.9	3.08	
55	8.6	2.36	9.1	2.49	9.4	2.57	9.6	2.62	9.7	2.67	10.0	2.75	10.3	2.83	

# VNMF Mini VRF 50/60Hz

Combination (%) (Capacity index)	Outdoor Air temperature (° C DB)	Indoor temperature (° C WB)													
		DB: 20.8, WB: 14		DB: 23.3, WB: 16		DB: 25.8, WB: 18		DB: 27, WB: 19		DB: 28.2, WB: 20		DB: 30.7, WB: 22		DB: 32, WB: 24	
		TC	PI	TC	PI	TC	PI	TC	PI	TC	PI	TC	PI	TC	PI
		kW	kW	kW	kW	kW	kW	kW	kW	kW	kW	kW	kW	kW	kW
110%	-5	9.5	1.43	10.0	1.51	10.3	1.55	10.6	1.58	10.8	1.62	11.1	1.66	11.4	1.71
	-2	9.3	1.44	9.8	1.52	10.1	1.57	10.3	1.60	10.6	1.63	10.9	1.68	11.2	1.73
	0	9.1	1.46	9.6	1.54	9.9	1.58	10.1	1.62	10.3	1.65	10.7	1.70	11.0	1.75
	2	9.0	1.47	9.4	1.55	9.7	1.60	9.9	1.63	10.1	1.67	10.4	1.71	10.7	1.76
	4	8.8	1.48	9.3	1.57	9.6	1.62	9.8	1.65	9.9	1.68	10.2	1.73	10.5	1.78
	6	8.6	1.50	9.1	1.58	9.4	1.63	9.6	1.67	9.8	1.70	10.0	1.75	10.3	1.80
	8	8.4	1.51	8.9	1.60	9.2	1.65	9.4	1.68	9.6	1.72	9.8	1.77	10.1	1.82
	10	11.3	2.01	11.9	2.12	12.3	2.19	12.5	2.23	12.8	2.28	13.2	2.35	13.6	2.41
	12	11.1	2.09	11.7	2.21	12.1	2.28	12.3	2.33	12.5	2.37	12.9	2.44	13.3	2.51
	14	10.9	2.18	11.5	2.30	11.8	2.38	12.1	2.42	12.3	2.47	12.7	2.54	13.0	2.62
	16	10.6	2.27	11.2	2.40	11.6	2.47	11.8	2.52	12.1	2.57	12.4	2.65	12.8	2.73
	18	12.4	2.55	13.0	2.69	13.5	2.77	13.7	2.83	14.0	2.89	14.4	2.97	14.8	3.06
	20	12.1	2.57	12.8	2.71	13.2	2.80	13.5	2.86	13.7	2.91	14.1	3.00	14.5	3.09
	21	11.9	2.60	12.5	2.74	12.9	2.83	13.2	2.89	13.5	2.94	13.9	3.03	14.3	3.12
	23	11.6	2.62	12.3	2.77	12.7	2.86	12.9	2.92	13.2	2.97	13.6	3.06	14.0	3.15
	25	11.4	2.65	12.1	2.80	12.4	2.89	12.7	2.95	12.9	3.00	13.3	3.09	13.7	3.18
	27	14.0	3.31	14.8	3.49	15.3	3.60	15.6	3.67	15.9	3.75	16.4	3.86	16.9	3.97
	29	13.8	3.34	14.5	3.53	15.0	3.64	15.3	3.71	15.6	3.79	16.1	3.90	16.5	4.01
	31	13.5	3.37	14.3	3.56	14.7	3.67	15.0	3.75	15.3	3.82	15.8	3.94	16.2	4.05
	33	13.2	3.41	14.0	3.60	14.4	3.71	14.7	3.79	15.0	3.86	15.4	3.98	15.9	4.09
35	13.0	3.44	13.7	3.63	14.1	3.75	14.4	3.83	14.7	3.90	15.1	4.02	15.6	4.13	
37	12.7	3.46	13.4	3.65	13.8	3.77	14.1	3.84	14.4	3.92	14.8	4.04	15.3	4.15	
39	12.1	3.39	12.8	3.58	13.2	3.69	13.4	3.77	13.7	3.84	14.1	3.96	14.5	4.07	
41	11.5	3.32	12.1	3.51	12.5	3.62	12.8	3.69	13.0	3.77	13.4	3.88	13.8	3.99	
43	10.9	3.26	11.5	3.44	11.9	3.55	12.1	3.62	12.4	3.69	12.7	3.80	13.1	3.91	
45	10.4	3.16	10.9	3.33	11.3	3.44	11.5	3.51	11.7	3.58	12.1	3.68	12.4	3.79	
48	9.8	3.00	10.4	3.17	10.7	3.27	10.9	3.33	11.2	3.40	11.5	3.50	11.8	3.60	
50	9.3	2.76	9.9	2.91	10.2	3.01	10.4	3.07	10.6	3.13	10.9	3.22	11.2	3.31	
52	8.9	2.54	9.4	2.68	9.7	2.77	9.9	2.82	10.1	2.88	10.4	2.96	10.7	3.05	
55	8.4	2.34	8.9	2.47	9.2	2.54	9.4	2.60	9.6	2.65	9.8	2.73	10.1	2.80	
100%	-5	9.2	1.40	9.7	1.48	10.0	1.52	10.2	1.55	10.5	1.58	10.8	1.63	11.1	1.68
	-2	9.0	1.41	9.5	1.49	9.8	1.54	10.0	1.57	10.2	1.60	10.5	1.65	10.9	1.69
	0	8.9	1.43	9.4	1.51	9.7	1.55	9.9	1.58	10.0	1.62	10.3	1.66	10.6	1.71
	2	8.7	1.44	9.2	1.52	9.5	1.57	9.7	1.60	9.9	1.63	10.1	1.68	10.4	1.73
	4	8.5	1.46	9.0	1.54	9.3	1.58	9.5	1.62	9.7	1.65	9.9	1.70	10.2	1.75
	6	8.4	1.47	8.8	1.55	9.1	1.60	9.3	1.63	9.5	1.67	9.7	1.72	10.0	1.76
	8	8.2	1.49	8.6	1.57	8.9	1.62	9.1	1.65	9.3	1.68	9.6	1.73	9.8	1.78
	10	11.0	1.97	11.6	2.08	11.9	2.15	12.2	2.19	12.4	2.23	12.8	2.30	13.2	2.36
	12	10.7	2.05	11.3	2.17	11.7	2.24	11.9	2.28	12.2	2.33	12.5	2.40	12.9	2.46
	14	10.5	2.14	11.1	2.26	11.5	2.33	11.7	2.38	11.9	2.42	12.3	2.49	12.6	2.57
	16	10.3	2.23	10.9	2.35	11.3	2.43	11.5	2.48	11.7	2.52	12.1	2.60	12.4	2.67
	18	12.0	2.50	12.7	2.64	13.1	2.72	13.3	2.77	13.6	2.83	14.0	2.91	14.4	3.00
	20	11.8	2.52	12.4	2.66	12.8	2.75	13.1	2.80	13.3	2.86	13.7	2.94	14.1	3.03
	21	11.5	2.55	12.2	2.69	12.6	2.77	12.8	2.83	13.1	2.89	13.5	2.97	13.8	3.06
	23	11.3	2.57	11.9	2.72	12.3	2.80	12.6	2.86	12.8	2.92	13.2	3.00	13.6	3.09
	25	11.1	2.60	11.7	2.74	12.1	2.83	12.3	2.89	12.6	2.95	12.9	3.03	13.3	3.12
	27	13.6	3.24	14.4	3.42	14.9	3.53	15.2	3.60	15.5	3.67	15.9	3.78	16.4	3.89
	29	13.4	3.27	14.1	3.46	14.6	3.57	14.9	3.64	15.2	3.71	15.6	3.82	16.0	3.93
	31	13.1	3.31	13.8	3.49	14.3	3.60	14.6	3.68	14.9	3.75	15.3	3.86	15.7	3.97
	33	12.9	3.34	13.6	3.53	14.0	3.64	14.3	3.71	14.6	3.79	15.0	3.90	15.4	4.01
35	12.6	3.38	13.3	3.56	13.7	3.68	14.0	3.75	14.3	3.83	14.7	3.94	15.1	4.05	
37	12.3	3.39	13.0	3.58	13.4	3.69	13.7	3.81	14.0	3.84	14.4	3.96	14.8	4.07	
39	11.7	3.32	12.4	3.51	12.8	3.62	13.4	3.87	13.3	3.77	13.7	3.88	14.1	3.99	
41	11.1	3.26	11.8	3.44	12.1	3.55	13.2	3.93	12.6	3.69	13.0	3.80	13.4	3.91	
43	10.6	3.19	11.2	3.37	11.5	3.48	12.9	4.00	12.0	3.62	12.4	3.72	12.7	3.83	
45	10.1	3.10	10.6	3.27	11.0	3.37	12.7	4.06	11.4	3.51	11.7	3.61	12.1	3.72	
48	9.6	2.94	10.1	3.11	10.4	3.20	12.4	4.12	10.8	3.33	11.1	3.43	11.5	3.53	
50	9.1	2.71	9.6	2.86	9.9	2.95	12.2	4.19	10.3	3.07	10.6	3.16	10.9	3.25	
52	8.6	2.49	9.1	2.63	9.4	2.71	11.9	4.26	9.8	2.82	10.1	2.90	10.3	2.99	
55	8.2	2.29	8.6	2.42	8.9	2.49	11.7	4.33	9.3	2.60	9.6	2.67	9.8	2.75	



Combination (%) (Capacity index)	Outdoor Air temperature (° C DB)	Indoor temperature (° C WB)													
		DB: 20.8, WB: 14		DB: 23.3, WB: 16		DB: 25.8, WB: 18		DB: 27, WB: 19		DB: 28.2, WB: 20		DB: 30.7, WB: 22		DB: 32, WB: 24	
		TC	PI	TC	PI	TC	PI	TC	PI	TC	PI	TC	PI	TC	PI
		kW	kW	kW	kW	kW	kW	kW	kW	kW	kW	kW	kW	kW	kW
90%	-5	8.8	1.31	9.2	1.39	9.5	1.43	9.7	1.46	9.9	1.49	10.2	1.53	10.5	1.58
	-2	8.6	1.33	9.1	1.40	9.4	1.45	9.5	1.47	9.7	1.50	10.0	1.55	10.3	1.59
	0	8.4	1.34	8.9	1.42	9.2	1.46	9.4	1.49	9.5	1.52	9.8	1.56	10.1	1.61
	2	8.3	1.35	8.7	1.43	9.0	1.47	9.2	1.50	9.4	1.54	9.6	1.58	9.9	1.63
	4	8.1	1.37	8.5	1.44	8.8	1.49	9.0	1.52	9.2	1.55	9.4	1.60	9.7	1.64
	6	7.9	1.38	8.4	1.46	8.6	1.50	8.8	1.54	9.0	1.57	9.3	1.61	9.5	1.66
	8	7.8	1.40	8.2	1.47	8.5	1.52	8.6	1.55	8.8	1.58	9.1	1.63	9.3	1.68
	10	10.4	1.85	11.0	1.96	11.3	2.02	11.6	2.06	11.8	2.10	12.2	2.16	12.5	2.22
	12	10.2	1.93	10.8	2.04	11.1	2.10	11.3	2.14	11.6	2.19	11.9	2.25	12.3	2.32
	14	10.0	2.01	10.6	2.12	10.9	2.19	11.1	2.23	11.3	2.28	11.7	2.35	12.0	2.41
	16	9.8	2.09	10.4	2.21	10.7	2.28	10.9	2.33	11.1	2.37	11.5	2.44	11.8	2.51
	18	11.4	2.35	12.0	2.48	12.4	2.56	12.7	2.61	12.9	2.66	13.3	2.74	13.7	2.82
	20	11.2	2.37	11.8	2.50	12.2	2.58	12.4	2.63	12.7	2.69	13.0	2.77	13.4	2.84
	21	11.0	2.39	11.6	2.53	11.9	2.61	12.2	2.66	12.4	2.71	12.8	2.79	13.2	2.87
	23	10.7	2.42	11.3	2.55	11.7	2.63	11.9	2.69	12.2	2.74	12.5	2.82	12.9	2.90
	25	10.5	2.44	11.1	2.58	11.5	2.66	11.7	2.71	11.9	2.77	12.3	2.85	12.6	2.93
	27	13.0	3.05	13.7	3.22	14.1	3.32	14.4	3.39	14.7	3.45	15.1	3.56	15.5	3.66
	29	12.7	3.08	13.4	3.25	13.8	3.35	14.1	3.42	14.4	3.49	14.8	3.59	15.2	3.69
	31	12.5	3.11	13.1	3.28	13.6	3.39	13.8	3.45	14.1	3.52	14.5	3.63	14.9	3.73
	33	12.2	3.14	12.9	3.32	13.3	3.42	13.6	3.49	13.8	3.56	14.2	3.66	14.7	3.77
35	12.0	3.17	12.6	3.35	13.0	3.45	13.3	3.53	13.6	3.60	14.0	3.70	14.4	3.81	
37	11.7	3.19	12.4	3.37	12.8	3.47	13.0	3.54	13.3	3.61	13.7	3.72	14.1	3.83	
39	11.1	3.12	11.8	3.30	12.1	3.40	12.4	3.47	12.6	3.54	13.0	3.65	13.4	3.75	
41	10.6	3.06	11.2	3.23	11.5	3.33	11.8	3.40	12.0	3.47	12.4	3.57	12.7	3.67	
43	10.1	3.00	10.6	3.17	11.0	3.27	11.2	3.33	11.4	3.40	11.7	3.50	12.1	3.60	
45	9.6	2.91	10.1	3.07	10.4	3.17	10.6	3.23	10.8	3.30	11.1	3.40	11.5	3.49	
48	9.1	2.77	9.6	2.92	9.9	3.01	10.1	3.07	10.3	3.13	10.6	3.23	10.9	3.32	
50	8.6	2.54	9.1	2.69	9.4	2.77	9.6	2.83	9.8	2.88	10.1	2.97	10.3	3.05	
52	8.2	2.34	8.6	2.47	8.9	2.55	9.1	2.60	9.3	2.65	9.6	2.73	9.8	2.81	
55	7.8	2.15	8.2	2.27	8.5	2.34	8.6	2.39	8.8	2.44	9.1	2.51	9.3	2.58	
80%	-5	7.9	1.19	8.4	1.25	8.6	1.29	8.8	1.32	9.0	1.35	9.3	1.39	9.5	1.43
	-2	7.8	1.20	8.2	1.27	8.5	1.31	8.6	1.33	8.8	1.36	9.1	1.40	9.3	1.44
	0	7.6	1.21	8.0	1.28	8.3	1.32	8.5	1.35	8.6	1.37	8.9	1.41	9.1	1.46
	2	7.5	1.22	7.9	1.29	8.1	1.33	8.3	1.36	8.5	1.39	8.7	1.43	9.0	1.47
	4	7.3	1.24	7.7	1.31	8.0	1.35	8.1	1.37	8.3	1.40	8.5	1.44	8.8	1.48
	6	7.2	1.25	7.6	1.32	7.8	1.36	8.0	1.39	8.1	1.42	8.4	1.46	8.6	1.50
	8	7.0	1.26	7.4	1.33	7.7	1.37	7.8	1.40	8.0	1.43	8.2	1.47	8.5	1.51
	10	9.4	1.68	10.0	1.77	10.3	1.82	10.5	1.86	10.7	1.90	11.0	1.95	11.3	2.01
	12	9.2	1.74	9.8	1.84	10.1	1.90	10.3	1.94	10.5	1.98	10.8	2.04	11.1	2.09
	14	9.1	1.82	9.6	1.92	9.9	1.98	10.1	2.02	10.3	2.06	10.6	2.12	10.9	2.18
	16	8.9	1.89	9.4	2.00	9.7	2.06	9.9	2.10	10.1	2.15	10.4	2.21	10.7	2.27
	18	10.3	2.12	10.9	2.24	11.2	2.31	11.5	2.36	11.7	2.40	12.0	2.48	12.4	2.55
	20	10.1	2.14	10.7	2.26	11.0	2.33	11.2	2.38	11.5	2.43	11.8	2.50	12.1	2.57
	21	9.9	2.16	10.5	2.29	10.8	2.36	11.0	2.41	11.2	2.45	11.6	2.53	11.9	2.60
	23	9.7	2.19	10.3	2.31	10.6	2.38	10.8	2.43	11.0	2.48	11.3	2.55	11.7	2.62
	25	9.5	2.21	10.1	2.33	10.4	2.41	10.6	2.45	10.8	2.50	11.1	2.58	11.4	2.65
	27	11.7	2.76	12.4	2.91	12.8	3.00	13.0	3.06	13.3	3.12	13.7	3.21	14.1	3.31
	29	11.5	2.78	12.1	2.94	12.5	3.03	12.8	3.09	13.0	3.15	13.4	3.25	13.8	3.34
	31	11.3	2.81	11.9	2.97	12.3	3.06	12.5	3.12	12.8	3.19	13.2	3.28	13.5	3.37
	33	11.1	2.84	11.7	3.00	12.0	3.09	12.3	3.16	12.5	3.22	12.9	3.31	13.3	3.41
35	10.8	2.87	11.4	3.03	11.8	3.12	12.0	3.19	12.3	3.25	12.6	3.35	13.0	3.44	
37	10.6	2.88	11.2	3.04	11.6	3.14	11.8	3.20	12.0	3.27	12.4	3.36	12.7	3.46	
39	10.1	2.83	10.6	2.98	11.0	3.08	11.2	3.14	11.4	3.20	11.8	3.30	12.1	3.39	
41	9.6	2.77	10.1	2.92	10.4	3.02	10.6	3.08	10.9	3.14	11.2	3.23	11.5	3.32	
43	9.1	2.71	9.6	2.86	9.9	2.95	10.1	3.02	10.3	3.08	10.6	3.17	10.9	3.26	
45	8.6	2.63	9.1	2.78	9.4	2.87	9.6	2.92	9.8	2.98	10.1	3.07	10.4	3.16	
48	8.2	2.50	8.7	2.64	8.9	2.72	9.1	2.78	9.3	2.83	9.6	2.92	9.9	3.00	
50	7.8	2.30	8.2	2.43	8.5	2.50	8.7	2.56	8.8	2.61	9.1	2.68	9.4	2.76	
52	7.4	2.12	7.8	2.23	8.1	2.30	8.2	2.35	8.4	2.40	8.7	2.47	8.9	2.54	
55	7.0	1.95	7.4	2.06	7.7	2.12	7.8	2.16	8.0	2.21	8.2	2.27	8.5	2.34	

Combination (%) (Capacity index)	Outdoor Air temperature (° C DB)	Indoor temperature (° C WB)													
		DB: 20.8, WB: 14		DB: 23.3, WB: 16		DB: 25.8, WB: 18		DB: 27, WB: 19		DB: 28.2, WB: 20		DB: 30.7, WB: 22		DB: 32, WB: 24	
		TC	PI	TC	PI	TC	PI	TC	PI	TC	PI	TC	PI	TC	PI
70%	-5	7.1	1.06	7.5	1.12	7.7	1.16	7.9	1.18	8.0	1.20	8.3	1.24	8.5	1.28
	-2	7.0	1.07	7.3	1.13	7.6	1.17	7.7	1.19	7.9	1.22	8.1	1.25	8.4	1.29
	0	6.8	1.08	7.2	1.14	7.4	1.18	7.6	1.20	7.7	1.23	8.0	1.26	8.2	1.30
	2	6.7	1.10	7.1	1.16	7.3	1.19	7.4	1.22	7.6	1.24	7.8	1.28	8.0	1.31
	4	6.6	1.11	6.9	1.17	7.1	1.20	7.3	1.23	7.4	1.25	7.7	1.29	7.9	1.33
	6	6.4	1.12	6.8	1.18	7.0	1.22	7.1	1.24	7.3	1.27	7.5	1.30	7.7	1.34
	8	6.3	1.13	6.7	1.19	6.9	1.23	7.0	1.25	7.1	1.28	7.4	1.32	7.6	1.35
	10	8.4	1.50	8.9	1.58	9.2	1.63	9.4	1.66	9.6	1.70	9.8	1.75	10.1	1.80
	12	8.3	1.56	8.7	1.65	9.0	1.70	9.2	1.73	9.4	1.77	9.7	1.82	9.9	1.87
	14	8.1	1.63	8.6	1.72	8.8	1.77	9.0	1.81	9.2	1.84	9.5	1.90	9.7	1.95
	16	8.0	1.69	8.4	1.79	8.7	1.84	8.8	1.88	9.0	1.92	9.3	1.98	9.5	2.03
	18	9.2	1.90	9.8	2.00	10.1	2.07	10.3	2.11	10.5	2.15	10.8	2.21	11.1	2.28
	20	9.1	1.92	9.6	2.02	9.9	2.09	10.1	2.13	10.3	2.17	10.6	2.24	10.9	2.30
	21	8.9	1.94	9.4	2.04	9.7	2.11	9.9	2.15	10.1	2.19	10.4	2.26	10.7	2.32
	23	8.7	1.96	9.2	2.06	9.5	2.13	9.7	2.17	9.9	2.22	10.2	2.28	10.5	2.35
	25	8.5	1.98	9.0	2.08	9.3	2.15	9.5	2.19	9.7	2.24	10.0	2.30	10.2	2.37
	27	10.5	2.46	11.1	2.60	11.4	2.68	11.7	2.74	11.9	2.79	12.3	2.87	12.6	2.96
	29	10.3	2.49	10.9	2.63	11.2	2.71	11.4	2.77	11.7	2.82	12.0	2.90	12.4	2.99
	31	10.1	2.51	10.7	2.65	11.0	2.74	11.2	2.79	11.4	2.85	11.8	2.93	12.1	3.02
	33	9.9	2.54	10.4	2.68	10.8	2.77	11.0	2.82	11.2	2.88	11.5	2.96	11.9	3.05
35	9.7	2.57	10.2	2.71	10.6	2.79	10.8	2.85	11.0	2.91	11.3	2.99	11.6	3.08	
37	9.5	2.58	10.0	2.72	10.4	2.81	10.6	2.86	10.8	2.92	11.1	3.01	11.4	3.09	
39	9.3	2.59	9.8	2.73	10.1	2.82	10.4	2.88	10.6	2.94	10.9	3.02	11.2	3.11	
41	9.1	2.60	9.6	2.75	9.9	2.84	10.1	2.89	10.3	2.95	10.7	3.04	11.0	3.12	
43	8.9	2.62	9.4	2.76	9.7	2.85	9.9	2.91	10.1	2.97	10.4	3.05	10.7	3.14	
45	8.8	2.63	9.3	2.78	9.5	2.86	9.7	2.92	9.9	2.98	10.2	3.07	10.5	3.16	
48	8.6	2.64	9.1	2.79	9.4	2.88	9.5	2.94	9.7	3.00	10.0	3.08	10.3	3.17	
50	8.4	2.66	8.9	2.80	9.2	2.89	9.4	2.95	9.5	3.01	9.8	3.10	10.1	3.19	
52	8.3	2.67	8.7	2.82	9.0	2.91	9.2	2.97	9.4	3.03	9.6	3.11	9.9	3.20	
55	8.1	2.68	8.5	2.83	8.8	2.92	9.0	2.98	9.2	3.04	9.4	3.13	9.7	3.22	
60%	-5	6.3	0.94	6.6	0.99	6.8	1.02	7.0	1.04	7.1	1.06	7.3	1.09	7.5	1.12
	-2	6.1	0.95	6.5	1.00	6.7	1.03	6.8	1.05	7.0	1.07	7.2	1.10	7.4	1.14
	0	6.0	0.96	6.4	1.01	6.6	1.04	6.7	1.06	6.8	1.08	7.0	1.12	7.2	1.15
	2	5.9	0.97	6.2	1.02	6.4	1.05	6.6	1.07	6.7	1.09	6.9	1.13	7.1	1.16
	4	5.8	0.98	6.1	1.03	6.3	1.06	6.4	1.08	6.6	1.11	6.8	1.14	7.0	1.17
	6	5.7	0.99	6.0	1.04	6.2	1.07	6.3	1.09	6.4	1.12	6.6	1.15	6.8	1.18
	8	5.6	0.99	5.9	1.05	6.1	1.08	6.2	1.11	6.3	1.13	6.5	1.16	6.7	1.19
	10	7.5	1.32	7.9	1.39	8.1	1.44	8.3	1.47	8.4	1.50	8.7	1.54	8.9	1.58
	12	7.3	1.38	7.7	1.45	8.0	1.50	8.1	1.53	8.3	1.56	8.5	1.60	8.8	1.65
	14	7.2	1.43	7.6	1.51	7.8	1.56	8.0	1.59	8.1	1.62	8.4	1.67	8.6	1.72
	16	7.0	1.49	7.4	1.58	7.7	1.63	7.8	1.66	8.0	1.69	8.2	1.74	8.4	1.79
	18	8.2	1.67	8.6	1.77	8.9	1.82	9.1	1.86	9.2	1.90	9.5	1.95	9.8	2.01
	20	8.0	1.69	8.4	1.78	8.7	1.84	8.9	1.88	9.1	1.91	9.3	1.97	9.6	2.03
	21	7.8	1.71	8.3	1.80	8.5	1.86	8.7	1.90	8.9	1.93	9.2	1.99	9.4	2.05
	23	7.7	1.72	8.1	1.82	8.4	1.88	8.5	1.92	8.7	1.95	9.0	2.01	9.2	2.07
	25	7.5	1.74	8.0	1.84	8.2	1.90	8.4	1.93	8.5	1.97	8.8	2.03	9.0	2.09
	27	9.3	2.17	9.8	2.29	10.1	2.37	10.3	2.41	10.5	2.46	10.8	2.53	11.1	2.61
	29	9.1	2.19	9.6	2.32	9.9	2.39	10.1	2.44	10.3	2.49	10.6	2.56	10.9	2.63
	31	8.9	2.22	9.4	2.34	9.7	2.41	9.9	2.46	10.1	2.51	10.4	2.59	10.7	2.66
	33	8.7	2.24	9.2	2.36	9.5	2.44	9.7	2.49	9.9	2.54	10.2	2.61	10.5	2.69
35	8.6	2.26	9.0	2.39	9.3	2.46	9.5	2.51	9.7	2.56	10.0	2.64	10.3	2.71	
37	8.4	2.27	8.9	2.40	9.1	2.47	9.3	2.53	9.5	2.58	9.8	2.65	10.1	2.73	
39	8.2	2.28	8.7	2.41	9.0	2.49	9.1	2.54	9.3	2.59	9.6	2.66	9.9	2.74	
41	8.1	2.30	8.5	2.42	8.8	2.50	9.0	2.55	9.1	2.60	9.4	2.68	9.7	2.75	
43	7.9	2.31	8.3	2.43	8.6	2.51	8.8	2.56	9.0	2.61	9.2	2.69	9.5	2.77	
45	7.7	2.32	8.2	2.45	8.4	2.52	8.6	2.58	8.8	2.63	9.0	2.70	9.3	2.78	
48	7.6	2.33	8.0	2.46	8.3	2.54	8.4	2.59	8.6	2.64	8.9	2.72	9.1	2.80	
50	7.4	2.34	7.9	2.47	8.1	2.55	8.3	2.60	8.4	2.65	8.7	2.73	8.9	2.81	
52	7.3	2.35	7.7	2.48	7.9	2.56	8.1	2.61	8.3	2.67	8.5	2.75	8.7	2.82	
55	7.1	2.37	7.5	2.50	7.8	2.58	7.9	2.63	8.1	2.68	8.3	2.76	8.6	2.84	

Combination (%) (Capacity index)	Outdoor Air temperature (° C DB)	Indoor temperature (° C WB)													
		DB: 20.8, WB: 14		DB: 23.3, WB: 16		DB: 25.8, WB: 18		DB: 27, WB: 19		DB: 28.2, WB: 20		DB: 30.7, WB: 22		DB: 32, WB: 24	
		TC	PI	TC	PI	TC	PI	TC	PI	TC	PI	TC	PI	TC	PI
		kW	kW	kW	kW	kW	kW	kW	kW	kW	kW	kW	kW	kW	kW
50%	-5	5.4	0.81	5.7	0.86	5.9	0.88	6.0	0.90	6.2	0.92	6.3	0.95	6.5	0.97
	-2	5.3	0.82	5.6	0.86	5.8	0.89	5.9	0.91	6.0	0.93	6.2	0.96	6.4	0.98
	0	5.2	0.83	5.5	0.87	5.7	0.90	5.8	0.92	5.9	0.94	6.1	0.97	6.3	0.99
	2	5.1	0.84	5.4	0.88	5.6	0.91	5.7	0.93	5.8	0.95	6.0	0.98	6.2	1.00
	4	5.0	0.84	5.3	0.89	5.5	0.92	5.6	0.94	5.7	0.96	5.9	0.98	6.0	1.01
	6	4.9	0.85	5.2	0.90	5.4	0.93	5.5	0.95	5.6	0.97	5.8	0.99	5.9	1.02
	8	4.8	0.86	5.1	0.91	5.3	0.94	5.4	0.96	5.5	0.98	5.6	1.00	5.8	1.03
	10	6.5	1.14	6.8	1.21	7.0	1.24	7.2	1.27	7.3	1.30	7.5	1.33	7.8	1.37
	12	6.3	1.19	6.7	1.26	6.9	1.30	7.0	1.32	7.2	1.35	7.4	1.39	7.6	1.43
	14	6.2	1.24	6.6	1.31	6.8	1.35	6.9	1.38	7.0	1.41	7.3	1.45	7.5	1.49
	16	6.1	1.29	6.4	1.36	6.6	1.41	6.8	1.44	6.9	1.46	7.1	1.51	7.3	1.55
	18	7.1	1.45	7.5	1.53	7.7	1.58	7.9	1.61	8.0	1.64	8.3	1.69	8.5	1.74
	20	6.9	1.46	7.3	1.54	7.6	1.59	7.7	1.63	7.9	1.66	8.1	1.71	8.3	1.76
	21	6.8	1.48	7.2	1.56	7.4	1.61	7.6	1.64	7.7	1.67	7.9	1.72	8.2	1.77
	23	6.7	1.49	7.0	1.58	7.3	1.62	7.4	1.66	7.6	1.69	7.8	1.74	8.0	1.79
	25	6.5	1.51	6.9	1.59	7.1	1.64	7.3	1.67	7.4	1.71	7.6	1.76	7.9	1.81
	27	8.0	1.88	8.5	1.98	8.8	2.05	8.9	2.09	9.1	2.13	9.4	2.19	9.7	2.26
	29	7.9	1.90	8.3	2.00	8.6	2.07	8.8	2.11	8.9	2.15	9.2	2.22	9.5	2.28
	31	7.7	1.92	8.2	2.03	8.4	2.09	8.6	2.13	8.8	2.17	9.0	2.24	9.3	2.30
	33	7.6	1.94	8.0	2.05	8.3	2.11	8.4	2.15	8.6	2.20	8.8	2.26	9.1	2.33
	35	7.4	1.96	7.8	2.07	8.1	2.13	8.3	2.18	8.4	2.22	8.7	2.28	8.9	2.35
	37	7.3	1.97	7.7	2.08	7.9	2.14	8.1	2.19	8.3	2.23	8.5	2.30	8.7	2.36
39	7.1	1.98	7.5	2.09	7.8	2.15	7.9	2.20	8.1	2.24	8.3	2.31	8.6	2.37	
41	7.0	1.99	7.4	2.10	7.6	2.16	7.8	2.21	7.9	2.25	8.2	2.32	8.4	2.38	
43	6.9	2.00	7.2	2.11	7.5	2.17	7.6	2.22	7.8	2.26	8.0	2.33	8.2	2.40	
45	6.7	2.01	7.1	2.12	7.3	2.19	7.5	2.23	7.6	2.27	7.8	2.34	8.1	2.41	
48	6.6	2.02	7.0	2.13	7.2	2.20	7.3	2.24	7.5	2.29	7.7	2.35	7.9	2.42	
50	6.5	2.03	6.8	2.14	7.0	2.21	7.2	2.25	7.3	2.30	7.5	2.36	7.7	2.43	
52	6.3	2.04	6.7	2.15	6.9	2.22	7.0	2.26	7.2	2.31	7.4	2.38	7.6	2.44	
55	6.2	2.05	6.5	2.16	6.7	2.23	6.9	2.27	7.0	2.32	7.2	2.39	7.4	2.46	

# VNMF Mini VRF 50/60Hz

VNMF345Q0A-G08V160

TC: Total Capacity (kW); PI: Power Input (kW) (Compressor + Outdoor fan motor)

Combination (%) (Capacity index)	Outdoor Air temperature (° C DB)	Indoor temperature (° C WB)													
		DB: 20.8, WB: 14		DB: 23.3, WB: 16		DB: 25.8, WB: 18		DB: 27, WB: 19		DB: 28.2, WB: 20		DB: 30.7, WB: 22		DB: 32, WB: 24	
		TC kW	PI kW	TC kW	PI kW	TC kW	PI kW	TC kW	PI kW	TC kW	PI kW	TC kW	PI kW	TC kW	PI kW
130%	-5	11.3	1.84	11.9	1.94	12.3	2.01	12.5	2.05	12.8	2.09	13.2	2.15	13.5	2.21
	-2	11.1	1.86	11.7	1.96	12.0	2.03	12.3	2.07	12.5	2.11	12.9	2.17	13.3	2.23
	0	10.8	1.88	11.4	1.98	11.8	2.05	12.0	2.09	12.3	2.13	12.6	2.19	13.0	2.25
	2	10.6	1.90	11.2	2.00	11.6	2.07	11.8	2.11	12.0	2.15	12.4	2.21	12.8	2.28
	4	10.4	1.92	11.0	2.02	11.3	2.09	11.6	2.13	11.8	2.17	12.2	2.24	12.5	2.30
	6	10.2	1.94	10.8	2.04	11.1	2.11	11.4	2.15	11.6	2.19	11.9	2.26	12.3	2.32
	8	10.0	1.96	10.6	2.06	10.9	2.13	11.1	2.17	11.4	2.22	11.7	2.28	12.0	2.35
	10	13.4	2.60	14.2	2.74	14.6	2.83	14.9	2.88	15.2	2.94	15.6	3.03	16.1	3.12
	12	13.1	2.70	13.9	2.85	14.3	2.94	14.6	3.00	14.9	3.06	15.3	3.16	15.8	3.25
	14	12.9	2.82	13.6	2.97	14.0	3.07	14.3	3.13	14.6	3.19	15.0	3.29	15.5	3.38
	16	12.6	2.93	13.3	3.10	13.8	3.20	14.0	3.26	14.3	3.33	14.7	3.42	15.2	3.52
	18	14.7	3.29	15.5	3.47	16.0	3.58	16.3	3.65	16.6	3.73	17.1	3.84	17.6	3.95
	20	14.4	3.32	15.2	3.51	15.7	3.62	16.0	3.69	16.3	3.76	16.8	3.88	17.3	3.99
	21	14.1	3.36	14.9	3.54	15.4	3.65	15.7	3.73	16.0	3.80	16.5	3.91	16.9	4.03
	23	13.8	3.39	14.6	3.58	15.1	3.69	15.4	3.77	15.7	3.84	16.1	3.95	16.6	4.07
	25	13.6	3.42	14.3	3.61	14.8	3.73	15.1	3.80	15.4	3.88	15.8	3.99	16.3	4.11
	27	16.7	4.27	17.6	4.51	18.2	4.65	18.5	4.75	18.9	4.84	19.5	4.98	20.0	5.12
	29	16.4	4.31	17.3	4.55	17.8	4.70	18.2	4.79	18.5	4.89	19.1	5.03	19.6	5.18
	31	16.0	4.36	16.9	4.60	17.5	4.74	17.8	4.84	18.2	4.94	18.7	5.08	19.2	5.23
	33	15.7	4.40	16.6	4.65	17.1	4.79	17.5	4.89	17.8	4.99	18.3	5.14	18.9	5.28
35	15.4	4.45	16.3	4.69	16.8	4.84	17.1	4.94	17.5	5.04	18.0	5.19	18.5	5.34	
37	15.1	4.47	15.9	4.72	16.4	4.87	16.8	4.96	17.1	5.06	17.6	5.21	18.1	5.36	
39	14.3	4.38	15.1	4.62	15.6	4.77	15.9	4.87	16.3	4.96	16.7	5.11	17.2	5.25	
41	13.6	4.29	14.4	4.53	14.8	4.67	15.1	4.77	15.4	4.86	15.9	5.01	16.4	5.15	
43	12.9	4.21	13.7	4.44	14.1	4.58	14.4	4.67	14.7	4.77	15.1	4.91	15.5	5.05	
45	12.3	4.08	13.0	4.31	13.4	4.44	13.7	4.53	13.9	4.62	14.3	4.76	14.8	4.90	
48	11.7	3.88	12.3	4.09	12.7	4.22	13.0	4.31	13.2	4.39	13.6	4.52	14.0	4.65	
50	11.1	3.57	11.7	3.76	12.1	3.88	12.3	3.96	12.6	4.04	12.9	4.16	13.3	4.28	
52	10.5	3.28	11.1	3.46	11.5	3.57	11.7	3.64	12.0	3.72	12.3	3.83	12.7	3.94	
55	10.0	3.02	10.6	3.19	10.9	3.29	11.1	3.35	11.4	3.42	11.7	3.52	12.0	3.62	
120%	-5	11.1	1.82	11.7	1.93	12.1	1.99	12.3	2.03	12.5	2.07	12.9	2.13	13.3	2.19
	-2	10.9	1.84	11.5	1.94	11.8	2.01	12.1	2.05	12.3	2.09	12.7	2.15	13.0	2.21
	0	10.6	1.86	11.2	1.96	11.6	2.03	11.8	2.07	12.1	2.11	12.4	2.17	12.8	2.23
	2	10.4	1.88	11.0	1.98	11.4	2.05	11.6	2.09	11.8	2.13	12.2	2.19	12.5	2.26
	4	10.2	1.90	10.8	2.00	11.1	2.07	11.4	2.11	11.6	2.15	11.9	2.22	12.3	2.28
	6	10.0	1.92	10.6	2.02	10.9	2.09	11.1	2.13	11.4	2.17	11.7	2.24	12.0	2.30
	8	9.8	1.94	10.4	2.05	10.7	2.11	10.9	2.15	11.1	2.20	11.5	2.26	11.8	2.32
	10	13.2	2.57	13.9	2.71	14.3	2.80	14.6	2.86	14.9	2.91	15.4	3.00	15.8	3.09
	12	12.9	2.68	13.6	2.83	14.0	2.92	14.3	2.98	14.6	3.04	15.0	3.12	15.5	3.21
	14	12.6	2.79	13.3	2.94	13.8	3.04	14.1	3.10	14.3	3.16	14.8	3.25	15.2	3.35
	16	12.4	2.91	13.1	3.07	13.5	3.16	13.8	3.23	14.1	3.29	14.5	3.39	14.9	3.49
	18	14.4	3.26	15.2	3.44	15.7	3.55	16.0	3.62	16.3	3.69	16.8	3.80	17.3	3.91
	20	14.1	3.29	14.9	3.47	15.4	3.58	15.7	3.66	16.0	3.73	16.5	3.84	16.9	3.95
	21	13.8	3.32	14.6	3.51	15.1	3.62	15.4	3.69	15.7	3.77	16.2	3.88	16.6	3.99
	23	13.6	3.36	14.3	3.54	14.8	3.65	15.1	3.73	15.4	3.80	15.8	3.92	16.3	4.03
	25	13.3	3.39	14.0	3.58	14.5	3.69	14.8	3.77	15.1	3.84	15.5	3.96	16.0	4.07
	27	16.4	4.23	17.3	4.46	17.8	4.61	18.2	4.70	18.5	4.79	19.1	4.93	19.6	5.08
	29	16.0	4.27	16.9	4.51	17.5	4.65	17.8	4.75	18.2	4.84	18.7	4.98	19.3	5.13
	31	15.7	4.32	16.6	4.56	17.1	4.70	17.5	4.80	17.8	4.89	18.4	5.03	18.9	5.18
	33	15.4	4.36	16.3	4.60	16.8	4.75	17.1	4.84	17.5	4.94	18.0	5.09	18.5	5.23
35	15.1	4.40	16.0	4.65	16.5	4.79	16.8	4.89	17.1	4.99	17.6	5.14	18.1	5.28	
37	14.8	4.43	15.6	4.67	16.1	4.82	16.5	4.92	16.8	5.02	17.3	5.16	17.8	5.31	
39	14.1	4.34	14.9	4.58	15.3	4.72	15.6	4.82	16.0	4.91	16.4	5.06	16.9	5.20	
41	13.4	4.25	14.1	4.49	14.6	4.63	14.9	4.72	15.2	4.82	15.6	4.96	16.0	5.10	
43	12.7	4.17	13.4	4.40	13.8	4.54	14.1	4.63	14.4	4.72	14.8	4.86	15.2	5.00	
45	12.1	4.04	12.7	4.26	13.1	4.40	13.4	4.49	13.7	4.58	14.1	4.71	14.5	4.85	
48	11.5	3.84	12.1	4.05	12.5	4.18	12.7	4.26	13.0	4.35	13.4	4.48	13.8	4.61	
50	10.9	3.53	11.5	3.73	11.9	3.84	12.1	3.92	12.3	4.00	12.7	4.12	13.1	4.24	
52	10.3	3.25	10.9	3.43	11.3	3.54	11.5	3.61	11.7	3.68	12.1	3.79	12.4	3.90	
55	9.8	2.99	10.4	3.15	10.7	3.25	10.9	3.32	11.1	3.39	11.5	3.49	11.8	3.59	

Combination (%) (Capacity index)	Outdoor Air temperature (° C DB)	Indoor temperature (° C WB)													
		DB: 20.8, WB: 14		DB: 23.3, WB: 16		DB: 25.8, WB: 18		DB: 27, WB: 19		DB: 28.2, WB: 20		DB: 30.7, WB: 22		DB: 32, WB: 24	
		TC kW	PI kW	TC kW	PI kW	TC kW	PI kW	TC kW	PI kW	TC kW	PI kW	TC kW	PI kW	TC kW	PI kW
110%	-5	10.9	1.81	11.5	1.91	11.8	1.97	12.1	2.01	12.3	2.05	12.7	2.11	13.0	2.17
	-2	10.6	1.82	11.2	1.93	11.6	1.99	11.8	2.03	12.1	2.07	12.4	2.13	12.8	2.19
	0	10.4	1.84	11.0	1.95	11.4	2.01	11.6	2.05	11.8	2.09	12.2	2.15	12.5	2.21
	2	10.2	1.86	10.8	1.97	11.1	2.03	11.4	2.07	11.6	2.11	11.9	2.17	12.3	2.23
	4	10.0	1.88	10.6	1.98	10.9	2.05	11.1	2.09	11.4	2.13	11.7	2.19	12.0	2.26
	6	9.8	1.90	10.4	2.00	10.7	2.07	10.9	2.11	11.1	2.15	11.5	2.22	11.8	2.28
	8	9.6	1.92	10.2	2.03	10.5	2.09	10.7	2.13	10.9	2.17	11.2	2.24	11.6	2.30
	10	12.9	2.55	13.6	2.69	14.1	2.77	14.3	2.83	14.6	2.89	15.1	2.97	15.5	3.06
	12	12.7	2.65	13.4	2.80	13.8	2.89	14.1	2.95	14.3	3.01	14.8	3.09	15.2	3.18
	14	12.4	2.76	13.1	2.92	13.5	3.01	13.8	3.07	14.1	3.13	14.5	3.22	14.9	3.32
	16	12.2	2.88	12.8	3.04	13.2	3.13	13.5	3.20	13.8	3.26	14.2	3.36	14.6	3.45
	18	14.1	3.23	14.9	3.40	15.4	3.51	15.7	3.58	16.0	3.66	16.5	3.76	17.0	3.87
	20	13.9	3.26	14.6	3.44	15.1	3.55	15.4	3.62	15.7	3.69	16.2	3.80	16.6	3.91
	21	13.6	3.29	14.3	3.47	14.8	3.58	15.1	3.66	15.4	3.73	15.8	3.84	16.3	3.95
	23	13.3	3.32	14.1	3.51	14.5	3.62	14.8	3.69	15.1	3.77	15.5	3.88	16.0	3.99
	25	13.1	3.36	13.8	3.54	14.2	3.66	14.5	3.73	14.8	3.81	15.2	3.92	15.7	4.03
	27	16.1	4.19	16.9	4.42	17.5	4.56	17.8	4.65	18.2	4.75	18.7	4.89	19.3	5.03
	29	15.7	4.23	16.6	4.47	17.1	4.61	17.5	4.70	17.8	4.80	18.4	4.94	18.9	5.08
	31	15.4	4.27	16.3	4.51	16.8	4.65	17.1	4.75	17.5	4.84	18.0	4.99	18.5	5.13
	33	15.1	4.32	16.0	4.56	16.5	4.70	16.8	4.80	17.1	4.89	17.7	5.04	18.2	5.18
35	14.8	4.36	15.7	4.60	16.2	4.75	16.5	4.85	16.8	4.94	17.3	5.09	17.8	5.23	
37	14.5	4.38	15.3	4.63	15.8	4.77	16.2	4.87	16.5	4.97	17.0	5.11	17.4	5.26	
39	13.8	4.29	14.6	4.53	15.0	4.68	15.3	4.77	15.6	4.87	16.1	5.01	16.6	5.15	
41	13.1	4.21	13.8	4.44	14.3	4.58	14.6	4.68	14.9	4.77	15.3	4.91	15.7	5.05	
43	12.5	4.12	13.2	4.35	13.6	4.49	13.8	4.58	14.1	4.67	14.5	4.81	15.0	4.95	
45	11.8	4.00	12.5	4.22	12.9	4.36	13.2	4.45	13.4	4.53	13.8	4.67	14.2	4.80	
48	11.2	3.80	11.9	4.01	12.2	4.14	12.5	4.22	12.7	4.31	13.1	4.43	13.5	4.56	
50	10.7	3.50	11.3	3.69	11.6	3.81	11.9	3.89	12.1	3.96	12.5	4.08	12.8	4.20	
52	10.2	3.22	10.7	3.40	11.1	3.50	11.3	3.57	11.5	3.65	11.8	3.75	12.2	3.86	
55	9.6	2.96	10.2	3.12	10.5	3.22	10.7	3.29	10.9	3.35	11.3	3.45	11.6	3.55	
100%	-5	10.5	1.77	11.1	1.87	11.5	1.93	11.7	1.97	11.9	2.01	12.3	2.07	12.6	2.13
	-2	10.3	1.79	10.9	1.89	11.3	1.95	11.5	1.99	11.7	2.03	12.1	2.09	12.4	2.15
	0	10.1	1.81	10.7	1.91	11.0	1.97	11.3	2.01	11.5	2.05	11.8	2.11	12.2	2.17
	2	9.9	1.83	10.5	1.93	10.8	1.99	11.0	2.03	11.3	2.07	11.6	2.13	11.9	2.19
	4	9.7	1.84	10.3	1.95	10.6	2.01	10.8	2.05	11.0	2.09	11.4	2.15	11.7	2.21
	6	9.5	1.86	10.1	1.97	10.4	2.03	10.6	2.07	10.8	2.11	11.1	2.17	11.5	2.23
	8	9.4	1.88	9.9	1.99	10.2	2.05	10.4	2.09	10.6	2.13	10.9	2.19	11.2	2.26
	10	12.5	2.50	13.2	2.63	13.6	2.72	13.9	2.77	14.2	2.83	14.6	2.91	15.0	3.00
	12	12.3	2.60	13.0	2.74	13.4	2.83	13.7	2.89	13.9	2.95	14.3	3.03	14.7	3.12
	14	12.0	2.71	12.7	2.86	13.1	2.95	13.4	3.01	13.7	3.07	14.1	3.16	14.5	3.25
	16	11.8	2.82	12.5	2.98	12.9	3.07	13.1	3.14	13.4	3.20	13.8	3.29	14.2	3.39
	18	13.7	3.16	14.5	3.34	14.9	3.44	15.2	3.51	15.5	3.58	16.0	3.69	16.5	3.79
	20	13.4	3.19	14.2	3.37	14.6	3.48	14.9	3.55	15.2	3.62	15.7	3.73	16.1	3.83
	21	13.2	3.23	13.9	3.41	14.4	3.51	14.6	3.58	14.9	3.66	15.4	3.76	15.8	3.87
	23	12.9	3.26	13.6	3.44	14.1	3.55	14.4	3.62	14.6	3.69	15.1	3.80	15.5	3.91
	25	12.7	3.29	13.4	3.47	13.8	3.58	14.1	3.66	14.4	3.73	14.8	3.84	15.2	3.95
	27	15.6	4.11	16.5	4.33	17.0	4.47	17.3	4.56	17.7	4.65	18.2	4.79	18.7	4.93
	29	15.3	4.15	16.1	4.38	16.6	4.52	17.0	4.61	17.3	4.70	17.8	4.84	18.3	4.98
	31	15.0	4.19	15.8	4.42	16.3	4.56	16.6	4.66	17.0	4.75	17.5	4.89	18.0	5.03
	33	14.7	4.23	15.5	4.47	16.0	4.61	16.3	4.70	16.6	4.80	17.1	4.94	17.6	5.08
35	14.4	4.28	15.2	4.51	15.7	4.66	16.0	4.75	16.3	4.85	16.8	4.99	17.3	5.13	
37	14.1	4.30	14.9	4.54	15.4	4.68	15.7	4.83	16.0	4.87	16.5	5.01	16.9	5.16	
39	13.4	4.21	14.2	4.44	14.6	4.58	15.4	4.90	15.2	4.77	15.6	4.91	16.1	5.05	
41	12.7	4.13	13.4	4.36	13.9	4.49	15.1	4.98	14.4	4.68	14.9	4.81	15.3	4.95	
43	12.1	4.04	12.8	4.27	13.2	4.40	14.8	5.06	13.7	4.58	14.1	4.72	14.5	4.85	
45	11.5	3.92	12.1	4.14	12.5	4.27	14.5	5.14	13.0	4.45	13.4	4.58	13.8	4.71	
48	10.9	3.73	11.5	3.93	11.9	4.06	14.2	5.22	12.4	4.22	12.7	4.35	13.1	4.47	
50	10.4	3.43	10.9	3.62	11.3	3.73	13.9	5.31	11.8	3.89	12.1	4.00	12.4	4.11	
52	9.9	3.15	10.4	3.33	10.7	3.43	13.6	5.39	11.2	3.57	11.5	3.68	11.8	3.78	
55	9.4	2.90	9.9	3.06	10.2	3.16	13.3	5.48	10.6	3.29	10.9	3.39	11.2	3.48	

# VNMF Mini VRF 50/60Hz

Combination (%) (Capacity index)	Outdoor Air temperature (° C DB)	Indoor temperature (° C WB)													
		DB: 20.8, WB: 14		DB: 23.3, WB: 16		DB: 25.8, WB: 18		DB: 27, WB: 19		DB: 28.2, WB: 20		DB: 30.7, WB: 22		DB: 32, WB: 24	
		TC kW	PI kW	TC kW	PI kW	TC kW	PI kW	TC kW	PI kW	TC kW	PI kW	TC kW	PI kW	TC kW	PI kW
90%	-5	10.0	1.66	10.6	1.76	10.9	1.81	11.1	1.85	11.3	1.89	11.7	1.94	12.0	2.00
	-2	9.8	1.68	10.4	1.77	10.7	1.83	10.9	1.87	11.1	1.91	11.5	1.96	11.8	2.02
	0	9.6	1.70	10.2	1.79	10.5	1.85	10.7	1.89	10.9	1.92	11.2	1.98	11.5	2.04
	2	9.4	1.72	10.0	1.81	10.3	1.87	10.5	1.91	10.7	1.94	11.0	2.00	11.3	2.06
	4	9.3	1.73	9.8	1.83	10.1	1.89	10.3	1.93	10.5	1.96	10.8	2.02	11.1	2.08
	6	9.1	1.75	9.6	1.85	9.9	1.91	10.1	1.94	10.3	1.98	10.6	2.04	10.9	2.10
	8	8.9	1.77	9.4	1.87	9.7	1.93	9.9	1.96	10.1	2.00	10.4	2.06	10.7	2.12
	10	11.9	2.35	12.6	2.48	13.0	2.56	13.2	2.61	13.5	2.66	13.9	2.74	14.3	2.82
	12	11.7	2.44	12.3	2.58	12.7	2.66	13.0	2.72	13.2	2.77	13.6	2.85	14.0	2.93
	14	11.4	2.55	12.1	2.69	12.5	2.77	12.7	2.83	13.0	2.89	13.3	2.97	13.7	3.06
	16	11.2	2.65	11.8	2.80	12.2	2.89	12.5	2.95	12.7	3.01	13.1	3.09	13.5	3.18
	18	13.0	2.97	13.8	3.14	14.2	3.24	14.5	3.30	14.8	3.37	15.2	3.47	15.6	3.57
	20	12.8	3.00	13.5	3.17	13.9	3.27	14.2	3.34	14.5	3.40	14.9	3.50	15.3	3.60
	21	12.5	3.03	13.2	3.20	13.6	3.30	13.9	3.37	14.2	3.44	14.6	3.54	15.0	3.64
	23	12.3	3.06	13.0	3.23	13.4	3.34	13.6	3.40	13.9	3.47	14.3	3.57	14.7	3.68
	25	12.0	3.09	12.7	3.27	13.1	3.37	13.4	3.44	13.6	3.51	14.0	3.61	14.4	3.71
	27	14.8	3.86	15.6	4.07	16.1	4.20	16.5	4.29	16.8	4.37	17.3	4.50	17.8	4.63
	29	14.5	3.90	15.3	4.12	15.8	4.25	16.1	4.33	16.5	4.42	16.9	4.55	17.4	4.68
	31	14.2	3.94	15.0	4.16	15.5	4.29	15.8	4.38	16.1	4.46	16.6	4.59	17.1	4.73
	33	14.0	3.98	14.7	4.20	15.2	4.33	15.5	4.42	15.8	4.51	16.3	4.64	16.7	4.77
35	13.7	4.02	14.4	4.24	14.9	4.38	15.2	4.47	15.5	4.55	16.0	4.69	16.4	4.82	
37	13.4	4.04	14.2	4.26	14.6	4.40	14.9	4.49	15.2	4.58	15.6	4.71	16.1	4.85	
39	12.7	3.96	13.4	4.18	13.9	4.31	14.2	4.40	14.4	4.49	14.9	4.62	15.3	4.75	
41	12.1	3.88	12.8	4.09	13.2	4.22	13.4	4.31	13.7	4.40	14.1	4.53	14.5	4.65	
43	11.5	3.80	12.1	4.01	12.5	4.14	12.8	4.22	13.0	4.31	13.4	4.43	13.8	4.56	
45	10.9	3.69	11.5	3.89	11.9	4.01	12.1	4.10	12.4	4.18	12.7	4.30	13.1	4.42	
48	10.4	3.50	10.9	3.70	11.3	3.81	11.5	3.89	11.8	3.97	12.1	4.09	12.4	4.20	
50	9.9	3.22	10.4	3.40	10.7	3.51	10.9	3.58	11.2	3.65	11.5	3.76	11.8	3.87	
52	9.4	2.96	9.9	3.13	10.2	3.23	10.4	3.29	10.6	3.36	10.9	3.46	11.2	3.56	
55	8.9	2.73	9.4	2.88	9.7	2.97	9.9	3.03	10.1	3.09	10.4	3.18	10.7	3.27	
80%	-5	9.1	1.51	9.6	1.59	9.9	1.64	10.1	1.67	10.3	1.71	10.6	1.76	10.9	1.81
	-2	8.9	1.52	9.4	1.60	9.7	1.66	9.9	1.69	10.1	1.72	10.4	1.77	10.7	1.82
	0	8.7	1.54	9.2	1.62	9.5	1.67	9.7	1.71	9.9	1.74	10.2	1.79	10.5	1.84
	2	8.5	1.55	9.0	1.64	9.3	1.69	9.5	1.72	9.7	1.76	10.0	1.81	10.3	1.86
	4	8.4	1.57	8.8	1.65	9.1	1.71	9.3	1.74	9.5	1.78	9.8	1.83	10.0	1.88
	6	8.2	1.58	8.7	1.67	8.9	1.72	9.1	1.76	9.3	1.79	9.6	1.85	9.9	1.90
	8	8.0	1.60	8.5	1.69	8.8	1.74	8.9	1.78	9.1	1.81	9.4	1.87	9.7	1.92
	10	10.8	2.12	11.4	2.24	11.7	2.31	12.0	2.36	12.2	2.40	12.6	2.48	12.9	2.55
	12	10.6	2.21	11.2	2.33	11.5	2.41	11.7	2.46	12.0	2.50	12.3	2.58	12.7	2.65
	14	10.4	2.30	10.9	2.43	11.3	2.51	11.5	2.56	11.7	2.61	12.1	2.69	12.4	2.76
	16	10.2	2.40	10.7	2.53	11.1	2.61	11.3	2.66	11.5	2.72	11.8	2.80	12.2	2.88
	18	11.8	2.69	12.5	2.84	12.8	2.93	13.1	2.99	13.4	3.05	13.8	3.14	14.2	3.23
	20	11.6	2.71	12.2	2.87	12.6	2.96	12.8	3.02	13.1	3.08	13.5	3.17	13.9	3.26
	21	11.3	2.74	12.0	2.89	12.3	2.99	12.6	3.05	12.8	3.11	13.2	3.20	13.6	3.29
	23	11.1	2.77	11.7	2.92	12.1	3.02	12.4	3.08	12.6	3.14	13.0	3.23	13.3	3.32
	25	10.9	2.80	11.5	2.95	11.9	3.05	12.1	3.11	12.4	3.17	12.7	3.26	13.1	3.36
	27	13.4	3.49	14.1	3.68	14.6	3.80	14.9	3.88	15.2	3.96	15.6	4.07	16.1	4.19
	29	13.1	3.53	13.9	3.72	14.3	3.84	14.6	3.92	14.9	4.00	15.3	4.11	15.8	4.23
	31	12.9	3.56	13.6	3.76	14.0	3.88	14.3	3.96	14.6	4.04	15.0	4.16	15.5	4.27
	33	12.6	3.60	13.3	3.80	13.8	3.92	14.0	4.00	14.3	4.08	14.7	4.20	15.2	4.32
35	12.4	3.63	13.1	3.84	13.5	3.96	13.8	4.04	14.0	4.12	14.4	4.24	14.9	4.36	
37	12.1	3.65	12.8	3.85	13.2	3.98	13.5	4.06	13.8	4.14	14.2	4.26	14.6	4.38	
39	11.5	3.58	12.2	3.78	12.6	3.90	12.8	3.98	13.1	4.06	13.5	4.18	13.8	4.29	
41	11.0	3.51	11.6	3.70	11.9	3.82	12.2	3.90	12.4	3.97	12.8	4.09	13.1	4.21	
43	10.4	3.44	11.0	3.63	11.3	3.74	11.6	3.82	11.8	3.90	12.1	4.01	12.5	4.12	
45	9.9	3.33	10.4	3.52	10.8	3.63	11.0	3.70	11.2	3.78	11.5	3.89	11.9	4.00	
48	9.4	3.17	9.9	3.34	10.2	3.45	10.4	3.52	10.6	3.59	11.0	3.70	11.3	3.80	
50	8.9	2.91	9.4	3.08	9.7	3.17	9.9	3.24	10.1	3.30	10.4	3.40	10.7	3.50	
52	8.5	2.68	8.9	2.83	9.2	2.92	9.4	2.98	9.6	3.04	9.9	3.13	10.2	3.22	
55	8.1	2.47	8.5	2.60	8.8	2.69	8.9	2.74	9.1	2.80	9.4	2.88	9.7	2.96	

Combination (%) (Capacity index)	Outdoor Air temperature (° C DB)	Indoor temperature (° C WB)													
		DB: 20.8, WB: 14		DB: 23.3, WB: 16		DB: 25.8, WB: 18		DB: 27, WB: 19		DB: 28.2, WB: 20		DB: 30.7, WB: 22		DB: 32, WB: 24	
		TC kW	PI kW	TC kW	PI kW	TC kW	PI kW	TC kW	PI kW	TC kW	PI kW	TC kW	PI kW	TC kW	PI kW
70%	-5	8.1	1.35	8.6	1.42	8.8	1.47	9.0	1.50	9.2	1.53	9.5	1.57	9.7	1.62
	-2	8.0	1.36	8.4	1.44	8.7	1.48	8.8	1.51	9.0	1.54	9.3	1.59	9.5	1.63
	0	7.8	1.37	8.2	1.45	8.5	1.50	8.7	1.53	8.8	1.56	9.1	1.60	9.4	1.65
	2	7.6	1.39	8.1	1.46	8.3	1.51	8.5	1.54	8.7	1.57	8.9	1.62	9.2	1.66
	4	7.5	1.40	7.9	1.48	8.2	1.53	8.3	1.56	8.5	1.59	8.7	1.63	9.0	1.68
	6	7.4	1.42	7.8	1.49	8.0	1.54	8.2	1.57	8.3	1.60	8.6	1.65	8.8	1.70
	8	7.2	1.43	7.6	1.51	7.8	1.56	8.0	1.59	8.2	1.62	8.4	1.67	8.6	1.72
	10	9.6	1.90	10.2	2.00	10.5	2.07	10.7	2.11	10.9	2.15	11.3	2.21	11.6	2.28
	12	9.5	1.98	10.0	2.09	10.3	2.15	10.5	2.20	10.7	2.24	11.0	2.31	11.4	2.37
	14	9.3	2.06	9.8	2.17	10.1	2.24	10.3	2.29	10.5	2.33	10.8	2.40	11.1	2.47
	16	9.1	2.14	9.6	2.26	9.9	2.33	10.1	2.38	10.3	2.43	10.6	2.50	10.9	2.57
	18	10.6	2.40	11.1	2.54	11.5	2.62	11.7	2.67	12.0	2.72	12.3	2.80	12.7	2.88
	20	10.4	2.43	10.9	2.56	11.3	2.64	11.5	2.70	11.7	2.75	12.1	2.83	12.4	2.91
	21	10.2	2.45	10.7	2.59	11.1	2.67	11.3	2.72	11.5	2.78	11.8	2.86	12.2	2.94
	23	10.0	2.48	10.5	2.61	10.8	2.70	11.1	2.75	11.3	2.81	11.6	2.89	11.9	2.97
	25	9.8	2.50	10.3	2.64	10.6	2.72	10.8	2.78	11.1	2.84	11.4	2.92	11.7	3.00
	27	12.0	3.12	12.7	3.29	13.1	3.40	13.3	3.47	13.6	3.54	14.0	3.64	14.4	3.75
	29	11.8	3.15	12.4	3.33	12.8	3.43	13.1	3.50	13.3	3.57	13.7	3.68	14.1	3.78
	31	11.5	3.18	12.2	3.36	12.6	3.47	12.8	3.54	13.1	3.61	13.5	3.72	13.8	3.82
	33	11.3	3.22	11.9	3.40	12.3	3.50	12.6	3.57	12.8	3.65	13.2	3.75	13.6	3.86
35	11.1	3.25	11.7	3.43	12.1	3.54	12.3	3.61	12.6	3.68	12.9	3.79	13.3	3.90	
37	10.9	3.27	11.5	3.45	11.8	3.56	12.1	3.63	12.3	3.70	12.7	3.81	13.0	3.92	
39	10.6	3.28	11.2	3.46	11.6	3.57	11.8	3.65	12.1	3.72	12.4	3.83	12.8	3.94	
41	10.4	3.30	11.0	3.48	11.4	3.59	11.6	3.66	11.8	3.74	12.2	3.85	12.5	3.96	
43	10.2	3.31	10.8	3.50	11.1	3.61	11.4	3.68	11.6	3.76	11.9	3.87	12.3	3.98	
45	10.0	3.33	10.6	3.52	10.9	3.63	11.1	3.70	11.4	3.78	11.7	3.89	12.0	4.00	
48	9.8	3.35	10.4	3.53	10.7	3.65	10.9	3.72	11.1	3.79	11.5	3.91	11.8	4.02	
50	9.6	3.36	10.2	3.55	10.5	3.66	10.7	3.74	10.9	3.81	11.2	3.93	11.6	4.04	
52	9.4	3.38	10.0	3.57	10.3	3.68	10.5	3.76	10.7	3.83	11.0	3.94	11.3	4.06	
55	9.2	3.40	9.8	3.59	10.1	3.70	10.3	3.78	10.5	3.85	10.8	3.96	11.1	4.08	
60%	-5	7.2	1.19	7.6	1.25	7.8	1.29	8.0	1.32	8.1	1.34	8.4	1.38	8.6	1.42
	-2	7.0	1.20	7.4	1.27	7.7	1.31	7.8	1.33	8.0	1.36	8.2	1.40	8.4	1.44
	0	6.9	1.21	7.3	1.28	7.5	1.32	7.7	1.35	7.8	1.37	8.0	1.41	8.3	1.45
	2	6.8	1.22	7.1	1.29	7.4	1.33	7.5	1.36	7.7	1.39	7.9	1.43	8.1	1.47
	4	6.6	1.24	7.0	1.30	7.2	1.34	7.4	1.37	7.5	1.40	7.7	1.44	7.9	1.48
	6	6.5	1.25	6.9	1.32	7.1	1.36	7.2	1.39	7.4	1.41	7.6	1.46	7.8	1.50
	8	6.4	1.26	6.7	1.33	6.9	1.37	7.1	1.40	7.2	1.43	7.4	1.47	7.6	1.51
	10	8.5	1.67	9.0	1.77	9.3	1.82	9.5	1.86	9.7	1.90	9.9	1.95	10.2	2.01
	12	8.4	1.74	8.8	1.84	9.1	1.90	9.3	1.94	9.5	1.97	9.7	2.03	10.0	2.09
	14	8.2	1.81	8.6	1.92	8.9	1.98	9.1	2.02	9.3	2.06	9.6	2.12	9.8	2.18
	16	8.0	1.89	8.5	2.00	8.7	2.06	8.9	2.10	9.1	2.14	9.4	2.21	9.6	2.27
	18	9.3	2.12	9.8	2.24	10.2	2.31	10.4	2.35	10.6	2.40	10.9	2.47	11.2	2.54
	20	9.1	2.14	9.7	2.26	10.0	2.33	10.2	2.38	10.4	2.43	10.7	2.50	11.0	2.57
	21	9.0	2.16	9.5	2.28	9.8	2.35	10.0	2.40	10.2	2.45	10.5	2.52	10.8	2.59
	23	8.8	2.18	9.3	2.30	9.6	2.38	9.8	2.43	10.0	2.47	10.3	2.55	10.5	2.62
	25	8.6	2.21	9.1	2.33	9.4	2.40	9.6	2.45	9.8	2.50	10.1	2.57	10.3	2.65
	27	10.6	2.75	11.2	2.90	11.5	3.00	11.8	3.06	12.0	3.12	12.4	3.21	12.7	3.30
	29	10.4	2.78	11.0	2.93	11.3	3.03	11.5	3.09	11.8	3.15	12.1	3.24	12.5	3.34
	31	10.2	2.81	10.8	2.96	11.1	3.06	11.3	3.12	11.5	3.18	11.9	3.28	12.2	3.37
	33	10.0	2.84	10.5	2.99	10.9	3.09	11.1	3.15	11.3	3.21	11.7	3.31	12.0	3.40
35	9.8	2.86	10.3	3.02	10.7	3.12	10.9	3.18	11.1	3.25	11.4	3.34	11.8	3.44	
37	9.6	2.88	10.1	3.04	10.4	3.13	10.7	3.20	10.9	3.26	11.2	3.36	11.5	3.45	
39	9.4	2.89	9.9	3.05	10.2	3.15	10.4	3.21	10.7	3.28	11.0	3.38	11.3	3.47	
41	9.2	2.91	9.7	3.07	10.0	3.17	10.2	3.23	10.4	3.30	10.8	3.39	11.1	3.49	
43	9.0	2.92	9.5	3.08	9.8	3.18	10.0	3.25	10.2	3.31	10.5	3.41	10.8	3.51	
45	8.9	2.94	9.3	3.10	9.6	3.20	9.8	3.26	10.0	3.33	10.3	3.43	10.6	3.52	
48	8.7	2.95	9.2	3.12	9.4	3.21	9.6	3.28	9.8	3.34	10.1	3.44	10.4	3.54	
50	8.5	2.97	9.0	3.13	9.3	3.23	9.4	3.30	9.6	3.36	9.9	3.46	10.2	3.56	
52	8.3	2.98	8.8	3.15	9.1	3.25	9.3	3.31	9.4	3.38	9.7	3.48	10.0	3.58	
55	8.2	3.00	8.6	3.16	8.9	3.26	9.1	3.33	9.3	3.40	9.5	3.50	9.8	3.59	

# VNMF Mini VRF 50/60Hz

Combination (%) (Capacity index)	Outdoor Air temperature (° C DB)	Indoor temperature (° C WB)													
		DB: 20.8, WB: 14		DB: 23.3, WB: 16		DB: 25.8, WB: 18		DB: 27, WB: 19		DB: 28.2, WB: 20		DB: 30.7, WB: 22		DB: 32, WB: 24	
		TC	PI	TC	PI	TC	PI	TC	PI	TC	PI	TC	PI	TC	PI
50%	-5	6.2	1.03	6.6	1.08	6.8	1.12	6.9	1.14	7.0	1.16	7.3	1.20	7.5	1.23
	-2	6.1	1.04	6.4	1.10	6.6	1.13	6.8	1.15	6.9	1.18	7.1	1.21	7.3	1.25
	0	6.0	1.05	6.3	1.11	6.5	1.14	6.6	1.16	6.8	1.19	7.0	1.22	7.2	1.26
	2	5.9	1.06	6.2	1.12	6.4	1.15	6.5	1.18	6.6	1.20	6.8	1.24	7.0	1.27
	4	5.7	1.07	6.1	1.13	6.3	1.16	6.4	1.19	6.5	1.21	6.7	1.25	6.9	1.28
	6	5.6	1.08	5.9	1.14	6.1	1.18	6.3	1.20	6.4	1.22	6.6	1.26	6.8	1.30
	8	5.5	1.09	5.8	1.15	6.0	1.19	6.1	1.21	6.3	1.24	6.4	1.27	6.6	1.31
	10	7.4	1.45	7.8	1.53	8.1	1.58	8.2	1.61	8.4	1.64	8.6	1.69	8.9	1.74
	12	7.2	1.51	7.7	1.59	7.9	1.64	8.1	1.68	8.2	1.71	8.5	1.76	8.7	1.81
	14	7.1	1.57	7.5	1.66	7.7	1.71	7.9	1.75	8.1	1.78	8.3	1.83	8.5	1.89
	16	7.0	1.64	7.4	1.73	7.6	1.78	7.7	1.82	7.9	1.85	8.1	1.91	8.4	1.96
	18	8.1	1.83	8.5	1.94	8.8	2.00	9.0	2.04	9.2	2.08	9.4	2.14	9.7	2.20
	20	7.9	1.85	8.4	1.96	8.6	2.02	8.8	2.06	9.0	2.10	9.3	2.16	9.5	2.22
	21	7.8	1.87	8.2	1.98	8.5	2.04	8.6	2.08	8.8	2.12	9.1	2.18	9.3	2.25
	23	7.6	1.89	8.0	2.00	8.3	2.06	8.5	2.10	8.6	2.14	8.9	2.21	9.2	2.27
	25	7.5	1.91	7.9	2.02	8.1	2.08	8.3	2.12	8.5	2.16	8.7	2.23	9.0	2.29
	27	9.2	2.38	9.7	2.51	10.0	2.59	10.2	2.65	10.4	2.70	10.7	2.78	11.0	2.86
	29	9.0	2.41	9.5	2.54	9.8	2.62	10.0	2.67	10.2	2.73	10.5	2.81	10.8	2.89
	31	8.8	2.43	9.3	2.57	9.6	2.65	9.8	2.70	10.0	2.75	10.3	2.84	10.6	2.92
	33	8.7	2.45	9.1	2.59	9.4	2.67	9.6	2.73	9.8	2.78	10.1	2.86	10.4	2.95
35	8.5	2.48	9.0	2.62	9.3	2.70	9.4	2.76	9.6	2.81	9.9	2.89	10.2	2.98	
37	8.3	2.49	8.8	2.63	9.1	2.71	9.3	2.77	9.4	2.82	9.7	2.91	10.0	2.99	
39	8.2	2.50	8.6	2.64	8.9	2.73	9.1	2.78	9.2	2.84	9.5	2.92	9.8	3.01	
41	8.0	2.52	8.4	2.66	8.7	2.74	8.9	2.80	9.1	2.85	9.3	2.94	9.6	3.02	
43	7.8	2.53	8.3	2.67	8.5	2.75	8.7	2.81	8.9	2.87	9.1	2.95	9.4	3.04	
45	7.7	2.54	8.1	2.68	8.4	2.77	8.5	2.82	8.7	2.88	9.0	2.97	9.2	3.05	
48	7.5	2.55	7.9	2.70	8.2	2.78	8.4	2.84	8.5	2.90	8.8	2.98	9.0	3.07	
50	7.4	2.57	7.8	2.71	8.0	2.80	8.2	2.85	8.4	2.91	8.6	3.00	8.9	3.08	
52	7.2	2.58	7.6	2.72	7.9	2.81	8.0	2.87	8.2	2.92	8.4	3.01	8.7	3.10	
55	7.1	2.59	7.5	2.74	7.7	2.82	7.9	2.88	8.0	2.94	8.3	3.03	8.5	3.11	

**Note:**

1. [ ] is tested under our standard condition.
2. In cooling mode, avoid running the unit when the outdoor air temperature is above 46 degrees.
3. The above table shows the average value of conditions may operate.



7.2 Heating

VNMF002Q0A-G04V080

TC: Total Capacity (kW); PI: Power Input (kW) (Compressor + Outdoor fan motor)

Combination (%) (Capacity index)	Outdoor Air temperature (° C DB)		Indoor temperature(° C WB)											
			16		18		20		21		22		24	
	° C DB	° C WB	TC kW	PI kW	TC kW	PI kW	TC kW	PI kW	TC kW	PI kW	TC kW	PI kW	TC kW	PI kW
130%	-19.8	-20	6.0	1.6	6.0	1.7	6.0	1.8	6.0	1.9	5.9	2.0	5.9	2.0
	-18.8	-19	6.1	1.6	6.1	1.8	6.1	1.9	6.0	1.9	6.0	2.0	6.0	2.1
	-16.7	-17	6.3	1.7	6.3	1.8	6.3	2.0	6.3	2.0	6.3	2.0	6.2	2.1
	-13.7	-15	6.6	1.8	6.6	1.9	6.5	2.0	6.5	2.0	6.5	2.1	6.5	2.2
	-11.8	-13	6.9	1.9	6.9	2.0	6.8	2.1	6.8	2.1	6.8	2.2	6.8	2.3
	-9.8	-11	7.2	2.0	7.2	2.0	7.1	2.1	7.1	2.2	7.1	2.3	7.1	2.4
	-9.5	-10	7.4	2.0	7.3	2.1	7.3	2.2	7.3	2.2	7.3	2.3	7.3	2.4
	-8.5	-9.1	7.5	2.0	7.5	2.1	7.5	2.2	7.5	2.3	7.5	2.3	7.4	2.4
	-7	-7.6	7.8	2.1	7.8	2.2	7.7	2.3	7.7	2.3	7.7	2.4	7.7	2.4
	-5	-5.6	8.2	2.2	8.2	2.3	8.1	2.4	8.1	2.4	8.1	2.4	8.1	2.5
	-3	-3.7	8.6	2.3	8.5	2.3	8.5	2.4	8.5	2.4	8.5	2.5	8.5	2.6
	0	-0.7	9.2	2.4	9.2	2.4	9.2	2.5	9.2	2.5	9.2	2.6	9.2	2.7
	3	2.2	10.0	2.4	9.9	2.5	9.9	2.6	9.9	2.6	9.9	2.7	9.9	2.7
	5	4.1	10.5	2.5	10.5	2.6	10.5	2.6	10.4	2.7	10.4	2.7	10.4	2.8
	7	6	11.0	2.6	11.0	2.6	11.0	2.7	11.0	2.7	11.0	2.8	10.5	2.7
9	7.9	11.6	2.6	11.5	2.7	11.5	2.8	11.5	2.8	11.3	2.7	10.5	2.5	
11	9.8	12.2	2.7	12.1	2.8	12.1	2.8	11.7	2.7	11.3	2.5	10.5	2.4	
13	11.8	12.8	2.8	12.8	2.8	12.1	2.6	11.7	2.5	11.3	2.4	10.5	2.2	
15	13.7	13.4	2.8	12.8	2.6	12.1	2.4	11.7	2.4	11.3	2.3	10.5	2.1	
120%	-19.8	-20	6.0	1.8	6.0	1.9	5.9	2.0	5.9	2.0	5.9	2.1	5.9	2.2
	-18.8	-19	6.1	1.8	6.0	1.9	6.0	2.0	6.0	2.0	6.0	2.1	6.0	2.2
	-16.7	-17	6.3	1.9	6.3	2.0	6.2	2.0	6.2	2.1	6.2	2.2	6.2	2.3
	-13.7	-15	6.6	2.0	6.5	2.0	6.5	2.1	6.5	2.2	6.5	2.2	6.5	2.3
	-11.8	-13	6.8	2.0	6.8	2.1	6.8	2.2	6.8	2.2	6.8	2.3	6.8	2.4
	-9.8	-11	7.2	2.1	7.1	2.2	7.1	2.3	7.1	2.3	7.1	2.4	7.1	2.4
	-9.5	-10	7.3	2.1	7.3	2.2	7.3	2.3	7.3	2.4	7.3	2.4	7.3	2.4
	-8.5	-9.1	7.5	2.2	7.5	2.2	7.5	2.3	7.4	2.4	7.4	2.4	7.4	2.5
	-7	-7.6	7.7	2.2	7.7	2.3	7.7	2.4	7.7	2.4	7.7	2.4	7.7	2.5
	-5	-5.6	8.2	2.3	8.1	2.4	8.1	2.4	8.1	2.5	8.1	2.5	8.1	2.6
	-3	-3.7	8.5	2.4	8.5	2.4	8.5	2.5	8.5	2.5	8.5	2.6	8.5	2.6
	0	-0.7	9.2	2.4	9.2	2.5	9.2	2.6	9.2	2.6	9.2	2.7	9.2	2.7
	3	2.2	9.9	2.5	9.9	2.6	9.9	2.7	9.9	2.7	9.9	2.8	9.7	2.7
	5	4.1	10.5	2.6	10.4	2.7	10.4	2.7	10.4	2.8	10.4	2.8	9.7	2.5
	7	6	11.0	2.7	11.0	2.7	11.0	2.8	10.8	2.7	10.4	2.6	9.7	2.4
9	7.9	11.5	2.7	11.5	2.8	11.1	2.7	10.8	2.6	10.4	2.4	9.7	2.3	
11	9.8	12.1	2.8	11.8	2.7	11.1	2.5	10.8	2.4	10.4	2.3	9.7	2.1	
13	11.8	12.6	2.7	11.8	2.5	11.1	2.4	10.8	2.3	10.4	2.2	9.7	2.0	
15	13.7	12.6	2.6	11.8	2.4	11.1	2.2	10.8	2.1	10.4	2.0	9.7	1.9	
110%	-19.8	-20	6.0	1.9	5.9	2.0	5.9	2.1	5.9	2.2	5.9	2.2	5.9	2.3
	-18.8	-19	6.0	2.0	6.0	2.0	6.0	2.1	6.0	2.2	6.0	2.2	6.0	2.3
	-16.7	-17	6.3	2.0	6.2	2.1	6.3	2.2	6.2	2.2	6.2	2.3	6.2	2.4
	-13.7	-15	6.5	2.1	6.5	2.2	6.5	2.3	6.5	2.3	6.5	2.4	6.5	2.4
	-11.8	-13	6.8	2.1	6.8	2.2	6.8	2.3	6.8	2.4	6.8	2.4	6.8	2.5
	-9.8	-11	7.1	2.2	7.1	2.3	7.1	2.4	7.1	2.4	7.1	2.4	7.1	2.5
	-9.5	-10	7.3	2.3	7.3	2.3	7.3	2.4	7.3	2.4	7.3	2.5	7.2	2.6
	-8.5	-9.1	7.5	2.3	7.4	2.4	7.4	2.4	7.4	2.5	7.4	2.5	7.4	2.3
	-7	-7.6	7.7	2.3	7.7	2.4	7.7	2.5	7.7	2.5	7.7	2.5	7.7	2.6
	-5	-5.6	8.1	2.4	8.1	2.5	8.1	2.5	8.1	2.6	8.1	2.6	8.0	2.7
	-3	-3.7	8.5	2.4	8.5	2.5	8.5	2.6	8.5	2.6	8.5	2.7	8.5	2.7
	0	-0.7	9.2	2.5	9.2	2.6	9.2	2.7	9.2	2.7	9.2	2.8	8.9	2.7
	3	2.2	9.9	2.6	9.9	2.7	9.9	2.8	9.9	2.8	9.5	2.7	8.9	2.4
	5	4.1	10.4	2.7	10.4	2.8	10.2	2.7	9.9	2.6	9.5	2.5	8.9	2.3
	7	6	11.0	2.8	10.9	2.8	10.2	2.5	9.9	2.4	9.5	2.4	8.9	2.2
9	7.9	11.5	2.8	10.9	2.6	10.2	2.4	9.9	2.3	9.5	2.2	8.9	2.0	
11	9.8	11.5	2.6	10.9	2.4	10.2	2.3	9.9	2.2	9.5	2.1	8.9	1.9	
13	11.8	11.5	2.4	10.9	2.3	10.2	2.1	9.9	2.0	9.5	2.0	8.9	1.8	
15	13.7	11.5	2.2	10.9	2.2	10.2	2.0	9.9	1.9	9.5	1.9	8.9	1.7	

Part 2 - Outdoor Units

# VNMF Mini VRF 50/60Hz

Combination (%) (Capacity index)	Outdoor Air temperature (° C DB)		Indoor temperature(° C WB)											
			16		18		20		21		22		24	
	° C DB	° C WB	TC kW	PI kW	TC kW	PI kW	TC kW	PI kW	TC kW	PI kW	TC kW	PI kW	TC kW	PI kW
100%	-19.8	-20	5.9	2.1	5.9	2.2	5.9	2.2	5.9	2.3	5.9	2.3	5.8	2.4
	-18.8	-19	6.0	2.1	6.0	2.2	6.0	2.3	6.0	2.3	6.0	2.4	6.0	2.4
	-16.7	-17	6.2	2.2	6.2	2.2	6.2	2.3	6.2	2.4	6.2	2.4	6.2	2.5
	-13.7	-15	6.5	2.2	6.5	2.3	6.5	2.4	6.5	2.4	6.5	2.4	6.4	2.5
	-11.8	-13	6.8	2.3	6.8	2.4	6.8	2.4	6.8	2.5	6.8	2.5	6.7	2.6
	-9.8	-11	7.1	2.4	7.1	2.4	7.1	2.5	7.1	2.5	7.0	2.6	7.0	2.6
	-9.5	-10	7.3	2.4	7.3	2.4	7.3	2.5	7.2	2.5	7.2	2.6	7.2	2.7
	-8.5	-9.1	7.4	2.4	7.4	2.5	7.4	2.5	7.4	2.6	7.4	2.6	7.4	2.7
	-7	-7.6	7.7	2.4	7.7	2.5	7.7	2.6	7.7	2.6	7.7	2.7	7.6	2.7
	-5	-5.6	8.1	2.5	8.1	2.6	8.1	2.6	8.0	2.7	8.0	2.7	8.0	2.8
	-3	-3.7	8.5	2.6	8.5	2.3	8.5	2.7	8.5	2.7	8.5	2.8	8.1	2.6
	0	-0.7	9.2	2.7	9.2	2.7	9.0	2.8	9.0	2.7	8.7	2.6	8.1	2.4
	3	2.2	9.9	2.7	9.9	2.8	9.0	2.6	9.0	2.5	8.7	2.4	8.1	2.2
	5	4.1	10.4	2.8	9.9	2.6	9.0	2.4	9.0	2.3	8.7	2.2	8.1	2.0
	7	6	10.5	2.6	9.9	2.4	9.0	2.3	9.0	2.2	8.7	2.1	8.1	2.0
9	7.9	10.5	2.5	9.9	2.3	9.0	2.1	9.0	2.0	8.7	2.0	8.1	1.8	
11	9.8	10.5	2.3	9.9	2.2	9.0	2.0	9.0	2.0	8.7	1.9	8.1	1.7	
13	11.8	10.5	2.2	9.9	2.0	9.0	1.9	9.0	1.8	8.7	1.8	8.1	1.6	
15	13.7	10.5	2.0	9.9	1.9	9.0	1.8	9.0	1.7	8.7	1.6	8.1	1.6	
90%	-19.8	-20	5.9	2.2	5.9	2.3	5.9	2.4	5.8	2.4	5.8	2.4	5.8	2.5
	-18.8	-19	6.0	2.3	6.0	2.3	5.9	2.4	5.9	2.4	5.9	2.5	5.9	2.6
	-16.7	-17	6.2	2.3	6.2	2.4	6.2	2.4	6.2	2.5	6.2	2.5	6.2	2.6
	-13.7	-15	6.5	2.4	6.4	2.4	6.4	2.5	6.4	2.5	6.4	2.6	6.4	2.6
	-11.8	-13	6.7	2.4	6.7	2.5	6.7	2.5	6.7	2.6	6.7	2.6	6.7	2.7
	-9.8	-11	7.1	2.5	7.1	2.5	7.0	2.6	7.0	2.6	7.0	2.7	7.0	2.8
	-9.5	-10	7.2	2.5	7.2	2.6	7.2	2.6	7.2	2.7	7.2	2.7	7.2	2.8
	-8.5	-9.1	7.4	2.5	7.4	2.6	7.4	2.7	7.4	2.7	7.4	2.7	7.3	2.8
	-7	-7.6	7.6	2.6	7.6	2.6	7.6	2.7	7.6	2.7	7.6	2.8	7.3	2.6
	-5	-5.6	8.1	2.6	8.0	2.7	8.0	2.8	8.0	2.8	7.8	2.7	7.3	2.4
	-3	-3.7	8.4	2.7	8.4	2.7	8.4	2.8	8.1	2.6	7.8	2.5	7.3	2.3
	0	-0.7	9.1	2.8	8.9	2.7	8.4	2.5	8.1	2.4	7.8	2.3	7.3	2.1
	3	2.2	9.4	2.6	8.9	2.4	8.4	2.3	8.1	2.2	7.8	2.1	7.3	1.9
	5	4.1	9.4	2.4	8.9	2.3	8.4	2.1	8.1	2.0	7.8	2.0	7.3	1.8
	7	6	9.4	2.3	8.9	2.2	8.4	2.0	8.1	2.0	7.8	1.9	7.3	1.7
9	7.9	9.4	2.2	8.9	2.0	8.4	1.9	8.1	1.8	7.8	1.8	7.3	1.6	
11	9.8	9.4	2.0	8.9	1.9	8.4	1.8	8.1	1.7	7.8	1.6	7.3	1.6	
13	11.8	9.4	2.0	8.9	1.8	8.4	1.7	8.1	1.6	7.8	1.6	7.3	1.5	
15	13.7	9.4	1.8	8.9	1.7	8.4	1.6	8.1	1.6	7.8	1.5	7.3	1.4	
80%	-19.8	-20	5.9	2.4	5.8	2.4	5.8	2.5	5.8	2.5	5.8	2.6	5.8	2.7
	-18.8	-19	6.0	2.4	6.0	2.4	5.9	2.5	5.9	2.6	5.9	2.6	5.9	2.7
	-16.7	-17	6.2	2.4	6.2	2.5	6.2	2.6	6.2	2.6	6.2	2.6	6.1	2.7
	-13.7	-15	6.5	2.5	6.4	2.6	6.4	2.6	6.4	2.7	6.4	2.7	6.4	2.8
	-11.8	-13	6.7	2.5	6.7	2.6	6.7	2.7	6.7	2.7	6.7	2.7	6.5	2.7
	-9.8	-11	7.0	2.6	7.0	2.7	7.0	2.7	7.0	2.8	7.0	2.8	6.5	2.5
	-9.5	-10	7.2	2.6	7.2	2.7	7.2	2.8	7.2	2.8	7.0	2.7	6.5	2.4
	-8.5	-9.1	7.4	2.7	6.8	2.7	7.3	2.8	7.2	2.7	7.0	2.6	6.5	2.4
	-7	-7.6	7.6	2.7	7.6	2.8	7.4	2.7	7.2	2.6	7.0	2.5	6.5	2.3
	-5	-5.6	8.0	2.8	7.9	2.7	7.4	2.5	7.2	2.4	7.0	2.3	6.5	2.1
	-3	-3.7	8.4	2.8	7.9	2.6	7.4	2.4	7.2	2.3	7.0	2.2	6.5	2.0
	0	-0.7	8.4	2.5	7.9	2.3	7.4	2.2	7.2	2.1	7.0	2.0	6.5	1.8
	3	2.2	8.4	2.3	7.9	2.1	7.4	2.0	7.2	1.9	7.0	1.8	6.5	1.7
	5	4.1	8.4	2.1	7.9	2.0	7.4	1.9	7.2	1.8	7.0	1.7	6.5	1.6
	7	6	8.4	2.0	7.9	1.9	7.4	1.8	7.2	1.7	7.0	1.6	6.5	1.5
9	7.9	8.4	1.9	7.9	1.8	7.4	1.6	7.2	1.6	7.0	1.6	6.5	1.4	
11	9.8	8.4	1.8	7.9	1.7	7.4	1.6	7.2	1.5	7.0	1.5	6.5	1.3	
13	11.8	8.4	1.7	7.9	1.6	7.4	1.5	7.2	1.4	7.0	1.4	6.5	1.3	
15	13.7	8.4	1.6	7.9	1.5	7.4	1.4	7.2	1.3	7.0	1.3	6.5	1.2	

Combination (%) (Capacity index)	Outdoor Air temperature (° C DB)		Indoor temperature(° C WB)											
			16		18		20		21		22		24	
	° C DB	° C WB	TC kW	PI kW	TC kW	PI kW	TC kW	PI kW	TC kW	PI kW	TC kW	PI kW	TC kW	PI kW
70%	-19.8	-20	5.8	2.5	5.8	2.6	5.8	2.7	5.8	2.7	5.8	2.7	5.7	2.7
	-18.8	-19	5.9	2.5	5.9	2.6	5.9	2.7	5.9	2.7	5.9	2.7	5.7	2.6
	-16.7	-17	6.1	2.6	6.1	2.7	6.1	2.7	6.1	2.8	6.1	2.4	5.7	2.5
	-13.7	-15	6.4	2.6	6.4	2.7	6.4	2.8	6.3	2.7	6.1	2.6	5.7	2.4
	-11.8	-13	6.7	2.7	6.7	2.8	6.5	2.7	6.3	2.6	6.1	2.4	5.7	2.3
	-9.8	-11	7.0	2.7	6.9	2.7	6.5	2.5	6.3	2.4	6.1	2.3	5.7	2.1
	-9.5	-10	7.2	2.8	6.9	2.6	6.5	2.4	6.3	2.4	6.1	2.3	5.7	2.1
	-8.5	-9.1	7.3	2.8	6.9	2.6	6.5	2.4	6.3	2.3	6.1	2.2	5.7	2.0
	-7	-7.6	7.3	2.6	6.9	2.4	6.5	2.3	6.3	2.2	6.1	2.1	5.7	2.0
	-5	-5.6	7.3	2.5	6.9	2.3	6.5	2.1	6.3	2.0	6.1	2.4	5.7	1.8
	-3	-3.7	7.3	2.3	6.9	2.2	6.5	2.0	6.3	2.0	6.1	1.9	5.7	1.7
	0	-0.7	7.3	2.1	6.9	2.0	6.5	1.9	6.3	1.8	6.1	1.7	5.7	1.6
	3	2.2	7.3	2.0	6.9	1.8	6.5	1.7	6.3	1.6	6.1	1.6	5.7	1.5
	5	4.1	7.3	1.8	6.9	1.7	6.5	1.6	6.3	1.6	6.1	1.5	5.7	1.4
	7	6	7.3	1.7	6.9	1.6	6.5	1.5	6.3	1.5	6.1	1.4	5.7	1.3
	9	7.9	7.3	1.6	6.9	1.6	6.5	1.4	6.3	1.4	6.1	1.3	5.7	1.2
11	9.8	7.3	1.6	6.9	1.5	6.5	1.4	6.3	1.3	6.1	1.3	5.7	1.2	
13	11.8	7.3	1.5	6.9	1.4	6.5	1.3	6.3	1.2	6.1	1.2	5.7	1.1	
15	13.7	7.3	1.4	6.9	1.3	6.5	1.2	6.3	1.2	6.1	1.2	5.7	1.1	
60%	-19.8	-20	5.8	2.7	5.8	2.8	5.6	2.6	5.4	2.5	5.2	2.4	4.9	2.2
	-18.8	-19	5.9	2.7	5.9	2.8	5.6	2.6	5.4	2.5	5.2	2.4	4.9	2.2
	-16.7	-17	6.1	2.8	5.9	2.7	5.6	2.4	5.4	2.4	5.2	2.3	4.9	2.1
	-13.7	-15	6.3	2.7	5.9	2.5	5.6	2.3	5.4	2.3	5.2	2.2	4.9	2.0
	-11.8	-13	6.3	2.6	5.9	2.4	5.6	2.2	5.4	2.1	5.2	2.0	4.9	1.9
	-9.8	-11	6.3	2.4	5.9	2.3	5.6	2.1	5.4	2.0	5.2	2.0	4.9	1.8
	-9.5	-10	6.3	2.4	5.9	2.2	5.6	2.0	5.4	2.0	5.2	1.9	4.9	1.7
	-8.5	-9.1	6.3	2.3	5.9	2.1	5.6	2.0	5.4	1.9	5.2	1.8	4.9	1.7
	-7	-7.6	6.3	2.2	5.9	2.0	5.6	1.9	5.4	1.8	5.2	1.8	4.9	1.6
	-5	-5.6	6.3	2.0	5.9	1.9	5.6	1.8	5.4	1.7	5.2	1.6	4.9	1.6
	-3	-3.7	6.3	2.0	5.9	1.8	5.6	1.7	5.4	1.6	5.2	1.6	4.9	1.5
	0	-0.7	6.3	1.8	5.9	1.6	5.6	1.6	5.4	1.5	5.2	1.5	4.9	1.3
	3	2.2	6.3	1.6	5.9	1.5	5.6	1.4	5.4	1.4	5.2	1.3	4.9	1.2
	5	4.1	6.3	1.6	5.9	1.5	5.6	1.3	5.4	1.3	5.2	1.2	4.9	1.2
	7	6	6.3	1.5	5.9	1.4	5.6	1.3	5.4	1.2	5.2	1.2	4.9	1.1
	9	7.9	6.3	1.4	5.9	1.3	5.6	1.2	5.4	1.2	5.2	1.2	4.9	1.1
11	9.8	6.3	1.3	5.9	1.2	5.6	1.2	5.4	1.1	5.2	1.1	4.9	1.0	
13	11.8	6.3	1.2	5.9	1.2	5.6	1.1	5.4	1.1	5.2	1.0	4.9	1.0	
15	13.7	6.3	1.2	5.9	1.1	5.6	1.1	5.4	1.0	5.2	1.0	4.9	0.9	
50%	-19.8	-20	5.2	2.4	4.9	2.3	4.7	2.1	4.5	2.0	4.3	2.0	4.0	1.8
	-18.8	-19	5.2	2.4	4.9	2.2	4.7	2.1	4.5	2.0	4.3	1.9	4.0	1.8
	-16.7	-17	5.2	2.3	4.9	2.1	4.7	2.0	4.5	1.9	4.3	1.8	4.0	1.7
	-13.7	-15	5.2	2.2	4.9	2.0	4.7	1.9	4.5	1.8	4.3	1.7	4.0	1.6
	-11.8	-13	5.2	2.0	4.9	1.9	4.7	1.8	4.5	1.7	4.3	1.6	4.0	1.6
	-9.8	-11	5.2	2.0	4.9	1.8	4.7	1.7	4.5	1.6	4.3	1.6	4.0	1.5
	-9.5	-10	5.2	1.9	4.9	1.8	4.7	1.6	4.5	1.6	4.3	1.6	4.0	1.4
	-8.5	-9.1	5.2	1.9	4.9	1.7	4.7	1.6	4.5	1.6	4.3	1.5	4.0	1.4
	-7	-7.6	5.2	1.8	4.9	1.6	4.7	1.6	4.5	1.5	4.3	1.4	4.0	1.3
	-5	-5.6	5.2	1.7	4.9	1.6	4.7	1.5	4.5	1.4	4.3	1.4	4.0	1.2
	-3	-3.7	5.2	1.6	4.9	1.5	4.7	1.4	4.5	1.3	4.3	1.3	4.0	1.2
	0	-0.7	5.2	1.5	4.9	1.4	4.7	1.3	4.5	1.2	4.3	1.2	4.0	1.1
	3	2.2	5.2	1.3	4.9	1.2	4.7	1.2	4.5	1.2	4.3	1.1	4.0	1.0
	5	4.1	5.2	1.3	4.9	1.2	4.7	1.1	4.5	1.1	4.3	1.1	4.0	1.0
	7	6	5.2	1.2	4.9	1.2	4.7	1.1	4.5	1.0	4.3	1.0	4.0	0.9
	9	7.9	5.2	1.2	4.9	1.1	4.7	1.0	4.5	1.0	4.3	0.9	4.0	0.9
11	9.8	5.2	1.1	4.9	1.0	4.7	1.0	4.5	0.9	4.3	0.9	4.0	0.8	
13	11.8	5.2	1.0	4.9	1.0	4.7	0.9	4.5	0.9	4.3	0.8	4.0	0.8	
15	13.7	5.2	1.0	4.9	0.9	4.7	0.9	4.5	0.8	4.3	0.8	4.0	0.8	

# VNMF Mini VRF 50/60Hz

VNMF253Q0A-G05V100

TC: Total Capacity (kW); PI: Power Input (kW) (Compressor + Outdoor fan motor)

Combination (%) (Capacity index)	Outdoor Air temperature (° C DB)		Indoor temperature(° C WB)											
			16		18		20		21		22		24	
	° C DB	° C WB	kW	kW	kW	kW	kW	kW	kW	kW	kW	kW	kW	kW
130%	-19.8	-20	7.4	2.0	7.4	2.1	7.4	2.3	7.4	2.3	7.3	2.4	7.3	2.5
	-18.8	-19	7.6	2.0	7.5	2.1	7.5	2.3	7.5	2.3	7.5	2.4	7.4	2.5
	-16.7	-17	7.8	2.1	7.8	2.3	7.8	2.4	7.8	2.5	7.8	2.5	7.7	2.7
	-13.7	-15	8.2	2.2	8.1	2.3	8.1	2.5	8.1	2.5	8.1	2.6	8.1	2.7
	-11.8	-13	8.5	2.3	8.5	2.4	8.5	2.5	8.4	2.6	8.4	2.7	8.4	2.8
	-9.8	-11	8.9	2.4	8.9	2.5	8.8	2.7	8.8	2.7	8.8	2.7	8.8	2.9
	-9.5	-10	9.1	2.5	9.1	2.6	9.1	2.7	9.1	2.7	9.0	2.8	9.0	2.9
	-8.5	-9.1	9.3	2.5	9.3	2.6	9.3	2.7	9.2	2.8	9.2	2.9	9.2	2.9
	-7	-7.6	9.6	2.6	9.6	2.7	9.6	2.8	9.6	2.9	9.6	2.9	9.5	3.0
	-5	-5.6	10.1	2.7	10.1	2.8	10.1	2.9	10.1	2.9	10.0	3.0	10.0	3.1
	-3	-3.7	10.6	2.7	10.6	2.9	10.6	2.9	10.6	3.0	10.6	3.1	10.5	3.1
	0	-0.7	11.5	2.9	11.5	3.0	11.4	3.1	11.4	3.1	11.4	3.2	11.4	3.3
	3	2.2	12.4	3.0	12.3	3.1	12.3	3.2	12.3	3.3	12.3	3.3	12.3	3.3
	5	4.1	13.0	3.1	13.0	3.2	13.0	3.3	12.9	3.3	12.9	3.3	12.9	3.4
	7	6	13.7	3.2	13.6	3.3	13.6	3.3	13.6	3.4	13.6	3.4	13.0	3.3
	9	7.9	14.3	3.3	14.3	3.3	14.3	3.4	14.3	3.4	14.0	3.3	13.0	3.1
11	9.8	15.1	3.3	15.0	3.4	15.0	3.4	14.5	3.3	14.0	3.1	13.0	2.9	
13	11.8	15.9	3.4	15.8	3.5	15.0	3.2	14.5	3.1	14.0	2.9	13.0	2.7	
15	13.7	16.6	3.5	15.9	3.3	15.0	3.0	14.5	2.9	14.0	2.8	13.0	2.5	
120%	-19.8	-20	7.4	2.1	7.4	2.3	7.3	2.4	7.3	2.5	7.3	2.5	7.3	2.7
	-18.8	-19	7.5	2.2	7.5	2.3	7.5	2.5	7.4	2.5	7.4	2.6	7.4	2.7
	-16.7	-17	7.8	2.3	7.8	2.4	7.7	2.5	7.7	2.6	7.7	2.7	7.7	2.8
	-13.7	-15	8.1	2.4	8.1	2.5	8.1	2.6	8.1	2.7	8.1	2.7	8.0	2.9
	-11.8	-13	8.5	2.5	8.5	2.6	8.4	2.7	8.4	2.7	8.4	2.8	8.4	2.9
	-9.8	-11	8.9	2.5	8.8	2.7	8.8	2.8	8.8	2.9	8.8	2.9	8.8	3.0
	-9.5	-10	9.1	2.6	9.1	2.7	9.0	2.8	9.0	2.9	9.0	2.9	9.0	3.1
	-8.5	-9.1	9.3	2.7	9.2	2.7	9.2	2.9	9.2	2.9	9.2	3.0	9.2	3.1
	-7	-7.6	9.6	2.7	9.6	2.8	9.6	2.9	9.6	3.0	9.5	3.0	9.5	3.1
	-5	-5.6	10.1	2.8	10.1	2.9	10.0	3.0	10.0	3.1	10.0	3.1	10.0	3.2
	-3	-3.7	10.6	2.9	10.6	3.0	10.6	3.1	10.6	3.1	10.5	3.2	10.5	3.3
	0	-0.7	11.4	3.0	11.4	3.1	11.4	3.2	11.4	3.3	11.4	3.3	11.4	3.3
	3	2.2	12.3	3.1	12.3	3.2	12.3	3.3	12.3	3.3	12.3	3.4	12.0	3.3
	5	4.1	13.0	3.2	12.9	3.3	12.9	3.3	12.9	3.4	12.9	3.5	12.0	3.1
	7	6	13.6	3.3	13.6	3.3	13.6	3.4	13.4	3.4	12.9	3.3	12.0	2.9
	9	7.9	14.3	3.3	14.3	3.4	13.8	3.3	13.4	3.1	12.9	3.1	12.0	2.8
11	9.8	15.0	3.4	14.7	3.3	13.8	3.1	13.4	3.0	12.9	2.9	12.0	2.6	
13	11.8	15.6	3.4	14.7	3.1	13.8	2.9	13.4	2.8	12.9	2.7	12.0	2.5	
15	13.7	15.6	3.2	14.7	2.9	13.8	2.7	13.4	2.6	12.9	2.5	12.0	2.3	
110%	-19.8	-20	7.4	2.3	7.3	2.5	7.3	2.6	7.3	2.7	7.3	2.7	7.3	2.8
	-18.8	-19	7.5	2.4	7.4	2.5	7.4	2.6	7.4	2.7	7.4	2.7	7.4	2.9
	-16.7	-17	7.8	2.5	7.7	2.6	7.8	2.7	7.7	2.7	7.7	2.8	7.7	2.9
	-13.7	-15	8.1	2.5	8.1	2.7	8.0	2.8	8.0	2.8	8.0	2.9	8.0	3.0
	-11.8	-13	8.4	2.7	8.4	2.7	8.4	2.9	8.4	2.9	8.4	2.9	8.4	3.1
	-9.8	-11	8.8	2.7	8.8	2.8	8.8	2.9	8.8	3.0	8.8	3.0	8.8	3.1
	-9.5	-10	9.1	2.8	9.0	2.9	9.0	2.9	9.0	3.0	9.0	3.1	8.9	3.1
	-8.5	-9.1	9.2	2.8	9.2	2.9	9.2	3.0	9.2	3.1	9.2	3.1	9.2	2.8
	-7	-7.6	9.6	2.9	9.6	2.9	9.5	3.1	9.5	3.1	9.5	3.1	9.5	3.3
	-5	-5.6	10.1	2.9	10.0	3.1	10.0	3.1	10.0	3.2	10.0	3.2	10.0	3.3
	-3	-3.7	10.6	3.1	10.6	3.1	10.5	3.2	10.5	3.3	10.5	3.3	10.5	3.4
	0	-0.7	11.4	3.1	11.4	3.2	11.4	3.3	11.4	3.3	11.4	3.4	11.0	3.3
	3	2.2	12.3	3.3	12.3	3.3	12.3	3.4	12.2	3.5	11.8	3.3	11.0	3.0
	5	4.1	12.9	3.3	12.9	3.4	12.7	3.3	12.2	3.2	11.8	3.1	11.0	2.8
	7	6	13.6	3.4	13.5	3.4	12.7	3.1	12.2	3.0	11.8	2.9	11.0	2.7
	9	7.9	14.3	3.5	13.5	3.2	12.7	2.9	12.2	2.9	11.8	2.7	11.0	2.5
11	9.8	14.3	3.3	13.5	3.0	12.7	2.8	12.2	2.7	11.8	2.5	11.0	2.3	
13	11.8	14.3	3.0	13.5	2.8	12.7	2.6	12.2	2.5	11.8	2.4	11.0	2.2	
15	13.7	14.3	2.7	13.5	2.7	12.7	2.5	12.2	2.3	11.8	2.3	11.0	2.1	

Combination (%) (Capacity index)	Outdoor Air temperature (° C DB)		Indoor temperature(° C WB)											
			16		18		20		21		22		24	
	° C DB	° C WB	TC kW	PI kW	TC kW	PI kW	TC kW	PI kW	TC kW	PI kW	TC kW	PI kW	TC kW	PI kW
100%	-19.8	-20	7.3	2.5	7.3	2.7	7.3	2.7	7.3	2.8	7.3	2.9	7.2	3.0
	-18.8	-19	7.4	2.6	7.4	2.7	7.4	2.8	7.4	2.9	7.4	2.9	7.4	3.0
	-16.7	-17	7.7	2.7	7.7	2.7	7.7	2.9	7.7	2.9	7.7	2.9	7.7	3.1
	-13.7	-15	8.1	2.7	8.0	2.8	8.0	2.9	8.0	3.0	8.0	3.0	8.0	3.1
	-11.8	-13	8.4	2.8	8.4	2.9	8.4	3.0	8.4	3.1	8.4	3.1	8.3	3.2
	-9.8	-11	8.8	2.9	8.8	3.0	8.8	3.1	8.8	3.1	8.7	3.1	8.7	3.3
	-9.5	-10	9.0	2.9	9.0	3.0	9.0	3.1	8.9	3.1	8.9	3.2	8.9	3.3
	-8.5	-9.1	9.2	2.9	9.2	3.1	9.2	3.1	9.2	3.2	9.1	3.2	9.1	3.3
	-7	-7.6	9.5	3.0	9.5	3.1	9.5	3.2	9.5	3.3	9.5	3.3	9.5	3.3
	-5	-5.6	10.0	3.1	10.0	3.2	10.0	3.3	10.0	3.3	10.0	3.3	9.9	3.4
	-3	-3.7	10.5	3.1	10.5	2.9	10.5	3.3	10.5	3.3	10.5	3.4	10.0	3.3
	0	-0.7	11.4	3.3	11.4	3.3	11.3	3.4	11.1	3.3	10.8	3.2	10.0	2.9
	3	2.2	12.3	3.4	12.2	3.5	11.5	3.2	11.1	3.1	10.8	2.9	10.0	2.7
	5	4.1	12.9	3.5	12.2	3.2	11.5	3.0	11.1	2.9	10.8	2.7	10.0	2.5
	7	6	13.0	3.3	12.2	3.0	11.5	2.9	11.1	2.7	10.8	2.6	10.0	2.4
9	7.9	13.0	3.1	12.2	2.9	11.5	2.7	11.1	2.5	10.8	2.5	10.0	2.3	
11	9.8	13.0	2.9	12.2	2.7	11.5	2.5	11.1	2.4	10.8	2.3	10.0	2.1	
13	11.8	13.0	2.7	12.2	2.5	11.5	2.3	11.1	2.3	10.8	2.1	10.0	2.0	
15	13.7	13.0	2.5	12.2	2.3	11.5	2.2	11.1	2.1	10.8	2.1	10.0	1.9	
90%	-19.8	-20	7.3	2.7	7.2	2.8	7.2	2.9	7.2	3.0	7.2	3.0	7.2	3.1
	-18.8	-19	7.4	2.7	7.4	2.9	7.4	2.9	7.4	3.0	7.4	3.1	7.3	3.1
	-16.7	-17	7.7	2.9	7.6	2.9	7.6	3.0	7.6	3.1	7.6	3.1	7.6	3.2
	-13.7	-15	8.0	2.9	8.0	3.0	8.0	3.1	7.9	3.1	7.9	3.2	7.9	3.3
	-11.8	-13	8.3	3.0	8.3	3.1	8.3	3.1	8.3	3.2	8.3	3.3	8.3	3.3
	-9.8	-11	8.7	3.1	8.7	3.1	8.7	3.2	8.7	3.3	8.7	3.3	8.7	3.4
	-9.5	-10	9.0	3.1	8.9	3.1	8.9	3.3	8.9	3.3	8.9	3.3	8.9	3.4
	-8.5	-9.1	9.1	3.1	9.1	3.2	9.1	3.3	9.1	3.3	9.1	3.3	9.0	3.4
	-7	-7.6	9.5	3.1	9.5	3.3	9.4	3.3	9.4	3.3	9.4	3.4	9.0	3.2
	-5	-5.6	10.0	3.3	9.9	3.3	9.9	3.4	9.9	3.4	9.7	3.3	9.0	3.0
	-3	-3.7	10.5	3.3	10.5	3.4	10.4	3.4	10.0	3.3	9.7	3.1	9.0	2.9
	0	-0.7	11.3	3.4	11.0	3.3	10.4	3.1	10.0	2.9	9.7	2.8	9.0	2.6
	3	2.2	11.7	3.3	11.0	3.0	10.4	2.8	10.0	2.7	9.7	2.6	9.0	2.3
	5	4.1	11.7	3.1	11.0	2.8	10.4	2.6	10.0	2.5	9.7	2.4	9.0	2.2
	7	6	11.7	2.9	11.0	2.7	10.4	2.5	10.0	2.4	9.7	2.3	9.0	2.1
9	7.9	11.7	2.7	11.0	2.5	10.4	2.3	10.0	2.3	9.7	2.1	9.0	2.0	
11	9.8	11.7	2.5	11.0	2.3	10.4	2.2	10.0	2.1	9.7	2.0	9.0	1.9	
13	11.8	11.7	2.4	11.0	2.2	10.4	2.1	10.0	2.0	9.7	2.0	9.0	1.8	
15	13.7	11.7	2.3	11.0	2.1	10.4	2.0	10.0	1.9	9.7	1.8	9.0	1.7	
80%	-19.8	-20	7.3	2.9	7.2	3.0	7.2	3.1	7.2	3.1	7.2	3.2	7.2	3.3
	-18.8	-19	7.4	2.9	7.4	3.1	7.3	3.1	7.3	3.2	7.3	3.2	7.3	3.3
	-16.7	-17	7.7	3.0	7.6	3.1	7.6	3.2	7.6	3.2	7.6	3.3	7.6	3.3
	-13.7	-15	8.0	3.1	8.0	3.1	8.0	3.3	8.0	3.3	7.9	3.3	7.9	3.4
	-11.8	-13	8.3	3.1	8.3	3.2	8.3	3.3	8.3	3.3	8.3	3.4	8.0	3.3
	-9.8	-11	8.7	3.2	8.7	3.3	8.7	3.3	8.7	3.4	8.6	3.4	8.0	3.1
	-9.5	-10	8.9	3.3	8.9	3.3	8.9	3.4	8.9	3.4	8.6	3.3	8.0	3.0
	-8.5	-9.1	9.1	3.3	8.5	3.3	9.1	3.4	8.9	3.3	8.6	3.2	8.0	2.9
	-7	-7.6	9.5	3.3	9.5	3.4	9.2	3.3	8.9	3.2	8.6	3.1	8.0	2.8
	-5	-5.6	10.0	3.4	9.8	3.3	9.2	3.1	8.9	3.0	8.6	2.9	8.0	2.6
	-3	-3.7	10.4	3.4	9.8	3.1	9.2	2.9	8.9	2.8	8.6	2.7	8.0	2.5
	0	-0.7	10.4	3.1	9.8	2.9	9.2	2.7	8.9	2.5	8.6	2.5	8.0	2.3
	3	2.2	10.4	2.8	9.8	2.6	9.2	2.4	8.9	2.3	8.6	2.3	8.0	2.1
	5	4.1	10.4	2.6	9.8	2.5	9.2	2.3	8.9	2.2	8.6	2.1	8.0	2.0
	7	6	10.4	2.5	9.8	2.3	9.2	2.1	8.9	2.1	8.6	2.0	8.0	1.9
9	7.9	10.4	2.3	9.8	2.2	9.2	2.0	8.9	2.0	8.6	1.9	8.0	1.8	
11	9.8	10.4	2.2	9.8	2.1	9.2	2.0	8.9	1.9	8.6	1.8	8.0	1.7	
13	11.8	10.4	2.1	9.8	2.0	9.2	1.8	8.9	1.8	8.6	1.7	8.0	1.6	
15	13.7	10.4	2.0	9.8	1.8	9.2	1.8	8.9	1.7	8.6	1.6	8.0	1.5	

# VNMF Mini VRF 50/60Hz

Combination (%) (Capacity index)	Outdoor Air temperature (° C DB)		Indoor temperature(° C WB)											
			16		18		20		21		22		24	
	° C DB	° C WB	TC kW	PI kW	TC kW	PI kW	TC kW	PI kW	TC kW	PI kW	TC kW	PI kW	TC kW	PI kW
70%	-19.8	-20	7.2	3.1	7.2	3.2	7.2	3.3	7.2	3.3	7.2	3.3	7.0	3.3
	-18.8	-19	7.3	3.1	7.3	3.2	7.3	3.3	7.3	3.3	7.3	3.4	7.0	3.3
	-16.7	-17	7.6	3.2	7.6	3.3	7.6	3.3	7.6	3.4	7.5	3.0	7.0	3.1
	-13.7	-15	7.9	3.3	7.9	3.3	7.9	3.4	7.8	3.3	7.5	3.2	7.0	2.9
	-11.8	-13	8.3	3.3	8.3	3.4	8.1	3.3	7.8	3.1	7.5	3.1	7.0	2.8
	-9.8	-11	8.7	3.3	8.6	3.3	8.1	3.1	7.8	3.0	7.5	2.9	7.0	2.6
	-9.5	-10	8.9	3.4	8.6	3.3	8.1	3.0	7.8	2.9	7.5	2.8	7.0	2.5
	-8.5	-9.1	9.1	3.4	8.6	3.2	8.1	2.9	7.8	2.8	7.5	2.7	7.0	2.5
	-7	-7.6	9.1	3.3	8.6	3.0	8.1	2.8	7.8	2.7	7.5	2.6	7.0	2.4
	-5	-5.6	9.1	3.1	8.6	2.9	8.1	2.7	7.8	2.5	7.5	3.0	7.0	2.3
	-3	-3.7	9.1	2.9	8.6	2.7	8.1	2.5	7.8	2.4	7.5	2.3	7.0	2.1
	0	-0.7	9.1	2.6	8.6	2.5	8.1	2.3	7.8	2.2	7.5	2.1	7.0	2.0
	3	2.2	9.1	2.4	8.6	2.2	8.1	2.1	7.8	2.0	7.5	2.0	7.0	1.8
	5	4.1	9.1	2.3	8.6	2.1	8.1	2.0	7.8	1.9	7.5	1.8	7.0	1.7
	7	6	9.1	2.1	8.6	2.0	8.1	1.9	7.8	1.8	7.5	1.8	7.0	1.6
	9	7.9	9.1	2.0	8.6	1.9	8.1	1.8	7.8	1.7	7.5	1.6	7.0	1.5
11	9.8	9.1	1.9	8.6	1.8	8.1	1.7	7.8	1.6	7.5	1.6	7.0	1.4	
13	11.8	9.1	1.8	8.6	1.7	8.1	1.6	7.8	1.5	7.5	1.5	7.0	1.4	
15	13.7	9.1	1.7	8.6	1.6	8.1	1.5	7.8	1.4	7.5	1.4	7.0	1.3	
60%	-19.8	-20	7.2	3.3	7.2	3.4	6.9	3.3	6.7	3.1	6.5	3.0	6.0	2.7
	-18.8	-19	7.3	3.3	7.3	3.4	6.9	3.2	6.7	3.1	6.5	2.9	6.0	2.7
	-16.7	-17	7.6	3.4	7.3	3.3	6.9	3.0	6.7	2.9	6.5	2.8	6.0	2.5
	-13.7	-15	7.8	3.3	7.3	3.1	6.9	2.9	6.7	2.7	6.5	2.7	6.0	2.4
	-11.8	-13	7.8	3.1	7.3	2.9	6.9	2.7	6.7	2.6	6.5	2.5	6.0	2.3
	-9.8	-11	7.8	3.0	7.3	2.8	6.9	2.6	6.7	2.5	6.5	2.4	6.0	2.2
	-9.5	-10	7.8	2.9	7.3	2.7	6.9	2.5	6.7	2.4	6.5	2.3	6.0	2.1
	-8.5	-9.1	7.8	2.8	7.3	2.6	6.9	2.5	6.7	2.3	6.5	2.3	6.0	2.1
	-7	-7.6	7.8	2.7	7.3	2.5	6.9	2.3	6.7	2.3	6.5	2.1	6.0	2.0
	-5	-5.6	7.8	2.5	7.3	2.3	6.9	2.2	6.7	2.1	6.5	2.0	6.0	1.9
	-3	-3.7	7.8	2.4	7.3	2.2	6.9	2.1	6.7	2.0	6.5	2.0	6.0	1.8
	0	-0.7	7.8	2.2	7.3	2.1	6.9	1.9	6.7	1.8	6.5	1.8	6.0	1.6
	3	2.2	7.8	2.0	7.3	1.9	6.9	1.8	6.7	1.7	6.5	1.6	6.0	1.5
	5	4.1	7.8	1.9	7.3	1.8	6.9	1.7	6.7	1.6	6.5	1.6	6.0	1.4
	7	6	7.8	1.8	7.3	1.7	6.9	1.6	6.7	1.5	6.5	1.5	6.0	1.4
	9	7.9	7.8	1.7	7.3	1.6	6.9	1.5	6.7	1.4	6.5	1.4	6.0	1.3
11	9.8	7.8	1.6	7.3	1.5	6.9	1.4	6.7	1.4	6.5	1.3	6.0	1.2	
13	11.8	7.8	1.5	7.3	1.4	6.9	1.4	6.7	1.3	6.5	1.2	6.0	1.2	
15	13.7	7.8	1.4	7.3	1.4	6.9	1.3	6.7	1.2	6.5	1.2	6.0	1.1	
50%	-19.8	-20	6.5	3.0	6.1	2.8	5.8	2.6	5.5	2.5	5.3	2.4	5.0	2.2
	-18.8	-19	6.5	2.9	6.1	2.7	5.8	2.5	5.5	2.5	5.3	2.3	5.0	2.1
	-16.7	-17	6.5	2.8	6.1	2.6	5.8	2.4	5.5	2.3	5.3	2.3	5.0	2.1
	-13.7	-15	6.5	2.7	6.1	2.5	5.8	2.3	5.5	2.2	5.3	2.1	5.0	2.0
	-11.8	-13	6.5	2.5	6.1	2.3	5.8	2.2	5.5	2.1	5.3	2.0	5.0	1.9
	-9.8	-11	6.5	2.4	6.1	2.2	5.8	2.1	5.5	2.0	5.3	2.0	5.0	1.8
	-9.5	-10	6.5	2.3	6.1	2.1	5.8	2.0	5.5	2.0	5.3	1.9	5.0	1.8
	-8.5	-9.1	6.5	2.3	6.1	2.1	5.8	2.0	5.5	1.9	5.3	1.8	5.0	1.7
	-7	-7.6	6.5	2.1	6.1	2.0	5.8	1.9	5.5	1.8	5.3	1.8	5.0	1.6
	-5	-5.6	6.5	2.1	6.1	2.0	5.8	1.8	5.5	1.8	5.3	1.7	5.0	1.6
	-3	-3.7	6.5	2.0	6.1	1.8	5.8	1.7	5.5	1.6	5.3	1.6	5.0	1.5
	0	-0.7	6.5	1.8	6.1	1.7	5.8	1.6	5.5	1.5	5.3	1.5	5.0	1.4
	3	2.2	6.5	1.6	6.1	1.6	5.8	1.4	5.5	1.4	5.3	1.4	5.0	1.2
	5	4.1	6.5	1.6	6.1	1.5	5.8	1.4	5.5	1.3	5.3	1.3	5.0	1.2
	7	6	6.5	1.5	6.1	1.4	5.8	1.3	5.5	1.3	5.3	1.2	5.0	1.2
	9	7.9	6.5	1.4	6.1	1.3	5.8	1.2	5.5	1.2	5.3	1.2	5.0	1.1
11	9.8	6.5	1.4	6.1	1.2	5.8	1.2	5.5	1.2	5.3	1.1	5.0	1.0	
13	11.8	6.5	1.3	6.1	1.2	5.8	1.1	5.5	1.1	5.3	1.0	5.0	1.0	
15	13.7	6.5	1.2	6.1	1.2	5.8	1.1	5.5	1.0	5.3	1.0	5.0	1.0	

VNMF003Q0A-G06V125

TC: Total Capacity (kW); PI: Power Input (kW) (Compressor + Outdoor fan motor)

Combination (%) (Capacity index)	Outdoor Air temperature (° C DB)		Indoor temperature(° C WB)													
			16		18		20		21		22		24			
	° C DB	° C WB	TC kW	PI kW	TC kW	PI kW	TC kW	PI kW	TC kW	PI kW	TC kW	PI kW	TC kW	PI kW		
130%	-19.8	-20	9.1	2.6	9.0	2.8	9.0	2.9	9.0	3.0	9.0	3.1	8.9	3.1	8.9	3.3
	-18.8	-19	9.2	2.6	9.2	2.8	9.2	3.0	9.1	3.1	9.1	3.2	9.1	3.2	9.1	3.4
	-16.7	-17	9.6	2.8	9.5	2.9	9.5	3.1	9.5	3.2	9.5	3.3	9.5	3.3	9.4	3.5
	-13.7	-15	10.0	2.9	9.9	3.1	9.9	3.2	9.9	3.3	9.8	3.4	9.8	3.4	9.8	3.6
	-11.8	-13	10.4	3.0	10.4	3.2	10.3	3.3	10.3	3.4	10.3	3.5	10.3	3.5	10.2	3.7
	-9.8	-11	10.9	3.1	10.8	3.3	10.8	3.5	10.8	3.5	10.8	3.6	10.8	3.6	10.7	3.8
	-9.5	-10	11.1	3.2	11.1	3.4	11.0	3.5	11.0	3.6	11.0	3.7	11.0	3.7	11.0	3.8
	-8.5	-9.1	11.3	3.3	11.3	3.4	11.3	3.6	11.2	3.6	11.2	3.7	11.2	3.7	11.2	3.8
	-7	-7.6	11.7	3.4	11.7	3.5	11.7	3.7	11.7	3.7	11.7	3.8	11.6	3.8	11.6	3.9
	-5	-5.6	12.4	3.5	12.3	3.6	12.3	3.8	12.3	3.8	12.3	3.9	12.2	3.9	12.2	4.0
	-3	-3.7	12.9	3.6	12.9	3.7	12.9	3.9	12.8	3.9	12.8	4.0	12.8	4.0	12.8	4.1
	0	-0.7	14.0	3.8	14.0	3.9	13.9	4.0	13.9	4.1	13.9	4.1	13.9	4.1	13.9	4.2
	3	2.2	15.1	3.9	15.0	4.0	15.0	4.2	15.0	4.2	15.0	4.3	14.9	4.3	14.9	4.4
	5	4.1	15.8	4.0	15.8	4.1	15.8	4.2	15.7	4.3	15.7	4.3	15.7	4.3	15.7	4.4
	7	6	16.6	4.1	16.6	4.2	16.6	4.3	16.5	4.4	16.5	4.4	16.5	4.4	15.9	4.2
9	7.9	17.5	4.2	17.4	4.3	17.4	4.4	17.4	4.4	17.0	4.4	15.9	4.0	15.9	4.0	
11	9.8	18.4	4.3	18.3	4.4	18.2	4.4	17.6	4.3	17.0	4.1	15.9	3.8	15.9	3.8	
13	11.8	19.3	4.4	19.3	4.5	18.2	4.2	17.6	4.0	17.0	3.8	15.9	3.5	15.9	3.5	
15	13.7	20.3	4.5	19.4	4.2	18.2	3.9	17.6	3.8	17.0	3.6	15.9	3.3	15.9	3.3	
120%	-19.8	-20	9.0	2.8	9.0	3.0	8.9	3.2	8.9	3.2	8.9	3.3	8.9	3.3	8.9	3.5
	-18.8	-19	9.2	2.9	9.1	3.0	9.1	3.2	9.1	3.3	9.1	3.4	9.0	3.4	9.0	3.5
	-16.7	-17	9.5	3.0	9.5	3.2	9.4	3.3	9.4	3.4	9.4	3.5	9.4	3.5	9.4	3.6
	-13.7	-15	9.9	3.1	9.9	3.3	9.8	3.4	9.8	3.5	9.8	3.6	9.8	3.6	9.8	3.7
	-11.8	-13	10.3	3.2	10.3	3.4	10.3	3.5	10.3	3.6	10.2	3.7	10.2	3.7	10.2	3.8
	-9.8	-11	10.8	3.4	10.8	3.5	10.8	3.6	10.7	3.7	10.7	3.8	10.7	3.8	10.7	3.9
	-9.5	-10	11.1	3.4	11.0	3.6	11.0	3.7	11.0	3.8	11.0	3.8	10.9	3.8	10.9	4.0
	-8.5	-9.1	11.3	3.5	11.2	3.6	11.2	3.7	11.2	3.8	11.2	3.9	11.2	3.9	11.2	4.0
	-7	-7.6	11.7	3.6	11.7	3.7	11.6	3.8	11.6	3.9	11.6	3.9	11.6	3.9	11.6	4.1
	-5	-5.6	12.3	3.7	12.3	3.8	12.2	3.9	12.2	4.0	12.2	4.0	12.2	4.0	12.2	4.2
	-3	-3.7	12.9	3.8	12.9	3.9	12.8	4.0	12.8	4.1	12.8	4.1	12.8	4.1	12.8	4.2
	0	-0.7	13.9	3.9	13.9	4.0	13.9	4.2	13.9	4.2	13.8	4.3	13.8	4.3	13.8	4.4
	3	2.2	15.0	4.1	15.0	4.2	15.0	4.3	14.9	4.3	14.9	4.4	14.6	4.4	14.6	4.4
	5	4.1	15.8	4.2	15.7	4.3	15.7	4.4	15.7	4.4	15.7	4.5	14.6	4.1	14.6	4.1
	7	6	16.6	4.3	16.6	4.4	16.5	4.4	16.3	4.4	15.7	4.2	14.6	3.8	14.6	3.8
9	7.9	17.4	4.3	17.4	4.4	16.8	4.3	16.3	4.1	15.7	3.9	14.6	3.6	14.6	3.6	
11	9.8	18.3	4.4	17.9	4.3	16.8	4.0	16.3	3.9	15.7	3.7	14.6	3.4	14.6	3.4	
13	11.8	19.0	4.4	17.9	4.1	16.8	3.8	16.3	3.6	15.7	3.5	14.6	3.2	14.6	3.2	
15	13.7	19.0	4.1	17.9	3.8	16.8	3.6	16.3	3.4	15.7	3.3	14.6	3.0	14.6	3.0	
110%	-19.8	-20	9.0	3.1	8.9	3.2	8.9	3.4	8.9	3.5	8.9	3.5	8.8	3.5	8.8	3.7
	-18.8	-19	9.1	3.1	9.1	3.3	9.1	3.4	9.1	3.5	9.0	3.6	9.0	3.6	9.0	3.7
	-16.7	-17	9.5	3.2	9.4	3.4	9.6	3.5	9.4	3.6	9.4	3.7	9.3	3.7	9.3	3.8
	-13.7	-15	9.9	3.3	9.8	3.5	9.8	3.6	9.8	3.7	9.8	3.8	9.7	3.8	9.7	3.9
	-11.8	-13	10.3	3.5	10.3	3.6	10.2	3.7	10.2	3.8	10.2	3.8	10.2	3.8	10.2	4.0
	-9.8	-11	10.8	3.6	10.7	3.7	10.7	3.8	10.7	3.9	10.7	3.9	10.7	3.9	10.7	4.1
	-9.5	-10	11.0	3.6	11.0	3.7	10.9	3.9	10.9	3.9	10.9	4.0	10.9	4.0	10.9	4.1
	-8.5	-9.1	11.2	3.7	11.2	3.8	11.2	3.9	11.2	4.0	11.2	4.0	11.2	4.0	11.2	3.7
	-7	-7.6	11.6	3.7	11.6	3.9	11.6	4.0	11.6	4.0	11.6	4.1	11.6	4.1	11.6	4.2
	-5	-5.6	12.3	3.8	12.2	4.0	12.2	4.1	12.2	4.1	12.2	4.2	12.1	4.2	12.1	4.3
	-3	-3.7	12.8	3.9	12.8	4.0	12.8	4.2	12.8	4.2	12.8	4.3	12.8	4.3	12.8	4.4
	0	-0.7	13.9	4.1	13.9	4.2	13.8	4.3	13.8	4.3	13.8	4.4	13.4	4.3	13.4	4.3
	3	2.2	15.0	4.2	14.9	4.3	14.9	4.4	14.9	4.5	14.4	4.3	13.4	3.9	13.4	3.9
	5	4.1	15.7	4.3	15.7	4.4	15.4	4.4	14.9	4.2	14.4	4.0	13.4	3.7	13.4	3.7
	7	6	16.5	4.4	16.4	4.4	15.4	4.1	14.9	3.9	14.4	3.8	13.4	3.5	13.4	3.5
9	7.9	17.4	4.5	16.4	4.2	15.4	3.8	14.9	3.7	14.4	3.6	13.4	3.3	13.4	3.3	
11	9.8	17.4	4.2	16.4	3.9	15.4	3.6	14.9	3.5	14.4	3.4	13.4	3.1	13.4	3.1	
13	11.8	17.4	3.9	16.4	3.7	15.4	3.4	14.9	3.3	14.4	3.2	13.4	2.9	13.4	2.9	
15	13.7	17.4	3.5	16.4	3.5	15.4	3.2	14.9	3.1	14.4	3.0	13.4	2.7	13.4	2.7	

Part 2 - Outdoor Units

# VNMF Mini VRF 50/60Hz

Combination (%) (Capacity index)	Outdoor Air temperature (° C DB)		Indoor temperature(° C WB)											
			16		18		20		21		22		24	
			TC	PI	TC	PI	TC	PI	TC	PI	TC	PI	TC	PI
	° C DB	° C WB	kW	kW	kW	kW	kW	kW	kW	kW	kW	kW	kW	kW
100%	-19.8	-20	8.9	3.3	8.9	3.5	8.9	3.6	8.8	3.7	8.8	3.7	8.8	3.9
	-18.8	-19	9.1	3.4	9.1	3.5	9.0	3.6	9.0	3.7	9.0	3.8	9.0	3.9
	-16.7	-17	9.4	3.5	9.4	3.6	9.4	3.7	9.3	3.8	9.3	3.8	9.3	4.0
	-13.7	-15	9.8	3.6	9.8	3.7	9.7	3.8	9.7	3.9	9.7	3.9	9.7	4.1
	-11.8	-13	10.2	3.7	10.2	3.8	10.2	3.9	10.2	4.0	10.2	4.0	10.1	4.1
	-9.8	-11	10.7	3.8	10.7	3.9	10.7	4.0	10.7	4.0	10.6	4.1	10.6	4.2
	-9.5	-10	11.0	3.8	10.9	3.9	10.9	4.0	10.9	4.1	10.9	4.2	10.8	4.3
	-8.5	-9.1	11.2	3.8	11.2	4.0	11.2	4.1	11.2	4.1	11.1	4.2	11.1	4.3
	-7	-7.6	11.6	3.9	11.6	4.0	11.6	4.1	11.6	4.2	11.6	4.2	11.5	4.4
	-5	-5.6	12.2	4.0	12.2	4.1	12.2	4.2	12.1	4.3	12.1	4.3	12.1	4.4
	-3	-3.7	12.8	4.1	12.8	3.7	12.8	4.3	12.8	4.4	12.8	4.4	12.2	4.2
	0	-0.7	13.8	4.2	13.8	4.3	13.8	4.4	13.6	4.4	13.1	4.2	12.2	3.8
	3	2.2	14.9	4.4	14.9	4.5	14.0	4.1	13.6	4.0	13.1	3.8	12.2	3.5
	5	4.1	15.7	4.5	14.9	4.2	14.0	3.9	13.6	3.7	13.1	3.6	12.2	3.3
	7	6	15.8	4.2	14.9	3.9	14.0	3.66	13.6	3.5	13.1	3.4	12.2	3.1
9	7.9	15.8	4.0	14.9	3.7	14.0	3.4	13.6	3.3	13.1	3.2	12.2	2.9	
11	9.8	15.8	3.7	14.9	3.5	14.0	3.2	13.6	3.1	13.1	3.0	12.2	2.8	
13	11.8	15.8	3.5	14.9	3.3	14.0	3.1	13.6	2.9	13.1	2.8	12.2	2.6	
15	13.7	15.8	3.3	14.9	3.1	14.0	2.9	13.6	2.8	13.1	2.7	12.2	2.5	
90%	-19.8	-20	8.9	3.6	8.8	3.7	8.8	3.8	8.8	3.9	8.8	3.9	8.8	4.1
	-18.8	-19	9.0	3.6	9.0	3.7	9.0	3.8	9.0	3.9	9.0	4.0	8.9	4.1
	-16.7	-17	9.4	3.7	9.3	3.8	9.3	3.9	9.3	4.0	9.3	4.0	9.3	4.2
	-13.7	-15	9.8	3.8	9.7	3.9	9.7	4.0	9.7	4.1	9.7	4.1	9.7	4.2
	-11.8	-13	10.2	3.9	10.2	4.0	10.1	4.1	10.1	4.1	10.1	4.2	10.1	4.3
	-9.8	-11	10.6	4.0	10.6	4.1	10.6	4.2	10.6	4.2	10.6	4.3	10.6	4.4
	-9.5	-10	10.9	4.0	10.9	4.1	10.9	4.2	10.8	4.3	10.8	4.3	10.8	4.4
	-8.5	-9.1	11.1	4.0	11.1	4.2	11.1	4.2	11.1	4.3	11.1	4.4	11.0	4.4
	-7	-7.6	11.5	4.1	11.5	4.2	11.5	4.3	11.5	4.4	11.5	4.4	11.0	4.2
	-5	-5.6	12.2	4.2	12.1	4.3	12.1	4.4	12.1	4.4	11.8	4.3	11.0	3.9
	-3	-3.7	12.7	4.3	12.7	4.4	12.6	4.4	12.2	4.2	11.8	4.0	11.0	3.7
	0	-0.7	13.8	4.4	13.4	4.3	12.6	4.0	12.2	3.8	11.8	3.7	11.0	3.4
	3	2.2	14.2	4.2	13.4	3.9	12.6	3.6	12.2	3.5	11.8	3.4	11.0	3.1
	5	4.1	14.2	4.0	13.4	3.7	12.6	3.4	12.2	3.3	11.8	3.2	11.0	2.9
	7	6	14.2	3.7	13.4	3.5	12.6	3.2	12.2	3.1	11.8	3.0	11.0	2.8
9	7.9	14.2	3.5	13.4	3.3	12.6	3.0	12.2	2.9	11.8	2.8	11.0	2.6	
11	9.8	14.2	3.3	13.4	3.1	12.6	2.9	12.2	2.8	11.8	2.7	11.0	2.5	
13	11.8	14.2	3.1	13.4	2.9	12.6	2.7	12.2	2.6	11.8	2.5	11.0	2.3	
15	13.7	14.2	2.9	13.4	2.7	12.6	2.6	12.2	2.5	11.8	2.4	11.0	2.2	
80%	-19.8	-20	8.8	3.8	8.8	3.9	8.8	4.0	8.8	4.1	8.8	4.1	8.8	4.3
	-18.8	-19	9.0	3.8	9.0	4.0	8.9	4.1	8.9	4.1	8.9	4.2	8.9	4.3
	-16.7	-17	9.3	3.9	9.3	4.0	9.3	4.1	9.3	4.2	9.3	4.2	9.2	4.3
	-13.7	-15	9.7	4.0	9.7	4.1	9.7	4.2	9.7	4.3	9.6	4.3	9.6	4.4
	-11.8	-13	10.1	4.1	10.1	4.2	10.1	4.3	10.1	4.3	10.1	4.4	9.8	4.3
	-9.8	-11	10.6	4.2	10.6	4.3	10.6	4.4	10.6	4.4	10.5	4.4	9.8	4.0
	-9.5	-10	10.9	4.2	10.8	4.3	10.9	4.4	10.9	4.4	10.5	4.3	9.8	3.9
	-8.5	-9.1	11.1	4.2	10.3	4.3	11.1	4.4	10.9	4.3	10.5	4.1	9.8	3.8
	-7	-7.6	11.5	4.3	11.5	4.4	11.2	4.3	10.9	4.1	10.5	4.0	9.8	3.6
	-5	-5.6	12.1	4.4	11.9	4.4	11.2	4.0	10.9	3.9	10.5	3.7	9.8	3.4
	-3	-3.7	12.6	4.4	11.9	4.1	11.2	3.8	10.9	3.7	10.5	3.5	9.8	3.2
	0	-0.7	12.6	4.0	11.9	3.7	11.2	3.5	10.9	3.3	10.5	3.2	9.8	2.9
	3	2.2	12.6	3.7	11.9	3.4	11.2	3.2	10.9	3.0	10.5	2.9	9.8	2.7
	5	4.1	12.6	3.4	11.9	3.2	11.2	3.0	10.9	2.9	10.5	2.8	9.8	2.6
	7	6	12.6	3.2	11.9	3.0	11.2	2.8	10.9	2.7	10.5	2.6	9.8	2.4
9	7.9	12.6	3.1	11.9	2.9	11.2	2.7	10.9	2.6	10.5	2.5	9.8	2.3	
11	9.8	12.6	2.9	11.9	2.7	11.2	2.5	10.9	2.4	10.5	2.3	9.8	2.2	
13	11.8	12.6	2.7	11.9	2.5	11.2	2.4	10.9	2.3	10.5	2.2	9.8	2.1	
15	13.7	12.6	2.6	11.9	2.4	11.2	2.3	10.9	2.2	10.5	2.1	9.8	2.0	



Combination (%) (Capacity index)	Outdoor Air temperature (° C DB)		Indoor temperature(° C WB)											
			16		18		20		21		22		24	
	° C DB	° C WB	TC kW	PI kW	TC kW	PI kW	TC kW	PI kW	TC kW	PI kW	TC kW	PI kW	TC kW	PI kW
70%	-19.8	-20	8.8	4.1	8.7	4.2	8.7	4.2	8.7	4.3	8.7	4.4	8.5	4.3
	-18.8	-19	8.9	4.1	8.9	4.2	8.9	4.3	8.9	4.3	8.9	4.4	8.5	4.2
	-16.7	-17	9.3	4.2	9.3	4.2	9.2	4.3	9.2	4.4	9.1	3.9	8.5	4.0
	-13.7	-15	9.7	4.2	9.6	4.3	9.6	4.4	9.5	4.3	9.1	4.2	8.5	3.8
	-11.8	-13	10.1	4.3	10.1	4.4	9.8	4.3	9.5	4.1	9.1	3.9	8.5	3.6
	-9.8	-11	10.6	4.4	10.4	4.4	9.8	4.0	9.5	3.9	9.1	3.7	8.5	3.4
	-9.5	-10	10.8	4.4	10.4	4.2	9.8	3.9	9.5	3.8	9.1	3.6	8.5	3.3
	-8.5	-9.1	11.0	4.4	10.4	4.1	9.8	3.8	9.5	3.7	9.1	3.5	8.5	3.3
	-7	-7.6	11.0	4.2	10.4	3.9	9.8	3.7	9.5	3.5	9.1	3.4	8.5	3.1
	-5	-5.6	11.0	4.0	10.4	3.7	9.8	3.4	9.5	3.3	9.1	3.9	8.5	2.9
	-3	-3.7	11.0	3.7	10.4	3.5	9.8	3.3	9.5	3.1	9.1	3.0	8.5	2.8
	0	-0.7	11.0	3.4	10.4	3.2	9.8	3.0	9.5	2.9	9.1	2.7	8.5	2.5
	3	2.2	11.0	3.1	10.4	2.9	9.8	2.7	9.5	2.6	9.1	2.5	8.5	2.3
	5	4.1	11.0	2.9	10.4	2.7	9.8	2.6	9.5	2.5	9.1	2.4	8.5	2.2
	7	6	11.0	2.8	10.4	2.6	9.8	2.4	9.5	2.3	9.1	2.3	8.5	2.1
	9	7.9	11.0	2.6	10.4	2.5	9.8	2.3	9.5	2.2	9.1	2.1	8.5	2.0
11	9.8	11.0	2.5	10.4	2.3	9.8	2.2	9.5	2.1	9.1	2.0	8.5	1.9	
13	11.8	11.0	2.3	10.4	2.2	9.8	2.1	9.5	2.0	9.1	1.9	8.5	1.8	
15	13.7	11.0	2.2	10.4	2.1	9.8	2.0	9.5	1.9	9.1	1.8	8.5	1.7	
60%	-19.8	-20	8.8	4.3	8.7	4.4	8.4	4.2	8.1	4.0	7.9	3.9	7.3	3.6
	-18.8	-19	8.9	4.3	8.9	4.4	8.4	4.1	8.1	4.0	7.9	3.8	7.3	3.5
	-16.7	-17	9.2	4.4	8.9	4.2	8.4	3.9	8.1	3.8	7.9	3.6	7.3	3.3
	-13.7	-15	9.5	4.3	8.9	4.0	8.4	3.7	8.1	3.6	7.9	3.5	7.3	3.2
	-11.8	-13	9.5	4.1	8.9	3.8	8.4	3.6	8.1	3.4	7.9	3.3	7.3	3.0
	-9.8	-11	9.5	3.9	8.9	3.6	8.4	3.4	8.1	3.2	7.9	3.1	7.3	2.9
	-9.5	-10	9.5	3.8	8.9	3.5	8.4	3.3	8.1	3.1	7.9	3.0	7.3	2.8
	-8.5	-9.1	9.5	3.7	8.9	3.4	8.4	3.2	8.1	3.1	7.9	2.9	7.3	2.7
	-7	-7.6	9.5	3.5	8.9	3.3	8.4	3.1	8.1	2.9	7.9	2.8	7.3	2.6
	-5	-5.6	9.5	3.3	8.9	3.1	8.4	2.9	8.1	2.8	7.9	2.7	7.3	2.5
	-3	-3.7	9.5	3.1	8.9	2.9	8.4	2.7	8.1	2.6	7.9	2.5	7.3	2.3
	0	-0.7	9.5	2.9	8.9	2.7	8.4	2.5	8.1	2.4	7.9	2.3	7.3	2.1
	3	2.2	9.5	2.6	8.9	2.5	8.4	2.3	8.1	2.2	7.9	2.1	7.3	2.0
	5	4.1	9.5	2.5	8.9	2.3	8.4	2.2	8.1	2.1	7.9	2.0	7.3	1.9
	7	6	9.5	2.3	8.9	2.2	8.4	2.1	8.1	2.0	7.9	1.9	7.3	1.8
	9	7.9	9.5	2.2	8.9	2.1	8.4	2.0	8.1	1.9	7.9	1.8	7.3	1.7
11	9.8	9.5	2.1	8.9	2.0	8.4	1.9	8.1	1.8	7.9	1.7	7.3	1.6	
13	11.8	9.5	2.0	8.9	1.9	8.4	1.8	8.1	1.7	7.9	1.7	7.3	1.5	
15	13.7	9.5	1.9	8.9	1.8	8.4	1.7	8.1	1.6	7.9	1.6	7.3	1.5	
50%	-19.8	-20	7.9	3.9	7.4	3.7	7.0	3.4	6.7	3.3	6.5	3.1	6.1	2.9
	-18.8	-19	7.9	3.8	7.4	3.6	7.0	3.3	6.7	3.2	6.5	3.1	6.1	2.8
	-16.7	-17	7.9	3.7	7.4	3.4	7.0	3.2	6.7	3.1	6.5	2.9	6.1	2.7
	-13.7	-15	7.9	3.5	7.4	3.3	7.0	3.0	6.7	2.9	6.5	2.8	6.1	2.6
	-11.8	-13	7.9	3.3	7.4	3.1	7.0	2.9	6.7	2.8	6.5	2.7	6.1	2.5
	-9.8	-11	7.9	3.1	7.4	2.9	7.0	2.7	6.7	2.6	6.5	2.5	6.1	2.3
	-9.5	-10	7.9	3.0	7.4	2.8	7.0	2.7	6.7	2.6	6.5	2.5	6.1	2.3
	-8.5	-9.1	7.9	3.0	7.4	2.8	7.0	2.6	6.7	2.5	6.5	2.4	6.1	2.2
	-7	-7.6	7.9	2.8	7.4	2.7	7.0	2.5	6.7	2.4	6.5	2.3	6.1	2.1
	-5	-5.6	7.9	2.7	7.4	2.5	7.0	2.4	6.7	2.3	6.5	2.2	6.1	2.0
	-3	-3.7	7.9	2.5	7.4	2.4	7.0	2.2	6.7	2.2	6.5	2.1	6.1	1.9
	0	-0.7	7.9	2.3	7.4	2.2	7.0	2.1	6.7	2.0	6.5	1.9	6.1	1.8
	3	2.2	7.9	2.1	7.4	2.0	7.0	1.9	6.7	1.8	6.5	1.8	6.1	1.7
	5	4.1	7.9	2.0	7.4	1.9	7.0	1.8	6.7	1.7	6.5	1.7	6.1	1.6
	7	6	7.9	1.9	7.4	1.8	7.0	1.7	6.7	1.7	6.5	1.6	6.1	1.5
	9	7.9	7.9	1.8	7.4	1.7	7.0	1.6	6.7	1.6	6.5	1.5	6.1	1.4
11	9.8	7.9	1.7	7.4	1.6	7.0	1.5	6.7	1.5	6.5	1.5	6.1	1.4	
13	11.8	7.9	1.7	7.4	1.6	7.0	1.5	6.7	1.4	6.5	1.4	6.1	1.3	
15	13.7	7.9	1.6	7.4	1.5	7.0	1.4	6.7	1.4	6.5	1.3	6.1	1.2	

# VNMF Mini VRF 50/60Hz

VNMF004Q0A-G07V140

TC: Total Capacity (kW); PI: Power Input (kW) (Compressor + Outdoor fan motor)

Combination (%) (Capacity index)	Outdoor Air temperature (° C DB)		Indoor temperature(° C WB)											
			16		18		20		21		22		24	
	° C DB	° C WB	TC kW	PI kW	TC kW	PI kW	TC kW	PI kW	TC kW	PI kW	TC kW	PI kW	TC kW	PI kW
130%	-19.8	-20	10.4	3.0	10.3	3.2	10.3	3.5	10.3	3.6	10.2	3.7	10.2	3.9
	-18.8	-19	10.5	3.1	10.5	3.3	10.5	3.5	10.4	3.6	10.4	3.7	10.4	3.9
	-16.7	-17	10.9	3.2	10.9	3.5	10.8	3.7	10.8	3.8	10.8	3.9	10.8	4.1
	-13.7	-15	11.4	3.4	11.3	3.6	11.3	3.8	11.3	3.9	11.2	4.0	11.2	4.2
	-11.8	-13	11.8	3.6	11.8	3.7	11.8	3.9	11.7	4.0	11.7	4.1	11.7	4.3
	-9.8	-11	12.4	3.7	12.3	3.9	12.3	4.1	12.3	4.2	12.3	4.2	12.2	4.4
	-9.5	-10	12.7	3.8	12.6	4.0	12.6	4.1	12.6	4.2	12.6	4.3	12.6	4.5
	-8.5	-9.1	13.0	3.9	12.9	4.0	12.9	4.2	12.9	4.3	12.9	4.4	12.8	4.5
	-7	-7.6	13.4	4.0	13.4	4.1	13.4	4.3	13.4	4.4	13.3	4.5	13.3	4.6
	-5	-5.6	14.1	4.1	14.1	4.3	14.0	4.4	14.0	4.5	14.0	4.6	14.0	4.7
	-3	-3.7	14.8	4.2	14.7	4.4	14.7	4.5	14.7	4.6	14.7	4.7	14.6	4.8
	0	-0.7	15.9	4.5	15.9	4.6	15.9	4.7	15.9	4.8	15.8	4.9	15.8	5.0
	3	2.2	17.2	4.6	17.2	4.8	17.1	4.9	17.1	5.0	17.1	5.0	17.1	5.1
	5	4.1	18.1	4.8	18.0	4.9	18.0	5.0	18.0	5.1	18.0	5.1	17.9	5.2
	7	6	19.0	4.9	19.0	5.0	19.0	5.1	18.9	5.2	18.9	5.2	18.1	5.0
9	7.9	20.0	5.0	19.9	5.1	19.9	5.2	19.9	5.2	19.4	5.1	18.1	4.7	
11	9.8	21.0	5.1	20.9	5.2	20.8	5.2	20.1	5.0	19.4	4.8	18.1	4.4	
13	11.8	22.1	5.2	22.0	5.3	20.8	4.9	20.1	4.7	19.4	4.5	18.1	4.2	
15	13.7	23.2	5.3	22.2	5.0	20.8	4.6	20.1	4.4	19.4	4.3	18.1	3.9	
120%	-19.8	-20	10.3	3.3	10.3	3.5	10.2	3.7	10.2	3.8	10.2	3.9	10.2	4.1
	-18.8	-19	10.5	3.4	10.4	3.6	10.4	3.8	10.4	3.9	10.4	4.0	10.3	4.2
	-16.7	-17	10.9	3.5	10.8	3.7	10.8	3.9	10.8	4.0	10.8	4.1	10.7	4.3
	-13.7	-15	11.3	3.7	11.3	3.8	11.2	4.0	11.2	4.1	11.2	4.2	11.2	4.4
	-11.8	-13	11.8	3.8	11.8	4.0	11.7	4.1	11.7	4.2	11.7	4.3	11.7	4.5
	-9.8	-11	12.3	3.9	12.3	4.1	12.3	4.3	12.2	4.4	12.2	4.4	12.2	4.6
	-9.5	-10	12.6	4.0	12.6	4.2	12.6	4.3	12.6	4.4	12.6	4.5	12.5	4.7
	-8.5	-9.1	12.9	4.1	12.9	4.2	12.9	4.4	12.8	4.5	12.8	4.6	12.7	4.7
	-7	-7.6	13.4	4.2	13.4	4.3	13.3	4.5	13.3	4.6	13.3	4.6	13.3	4.8
	-5	-5.6	14.1	4.3	14.0	4.5	14.0	4.6	14.0	4.7	14.0	4.8	13.9	4.9
	-3	-3.7	14.7	4.5	14.7	4.6	14.7	4.7	14.7	4.8	14.6	4.9	14.6	5.0
	0	-0.7	15.9	4.6	15.9	4.8	15.8	4.9	15.8	5.0	15.8	5.0	15.8	5.1
	3	2.2	17.2	4.8	17.1	4.9	17.1	5.0	17.1	5.1	17.1	5.2	16.7	5.1
	5	4.1	18.0	4.9	18.0	5.0	18.0	5.1	17.9	5.2	17.9	5.3	16.7	4.8
	7	6	19.0	5.0	19.0	5.1	18.9	5.2	18.6	5.2	18.0	5.0	16.7	4.5
9	7.9	19.9	5.1	19.9	5.2	19.2	5.0	18.6	4.8	18.0	4.7	16.7	4.3	
11	9.8	20.9	5.2	20.4	5.1	19.2	4.7	18.6	4.6	18.0	4.4	16.7	4.0	
13	11.8	21.7	5.2	20.4	4.8	19.2	4.5	18.6	4.3	18.0	4.1	16.7	3.8	
15	13.7	21.7	4.9	20.4	4.5	19.2	4.2	18.6	4.0	18.0	3.9	16.7	3.6	
110%	-19.8	-20	10.3	3.6	10.2	3.8	10.2	4.0	10.2	4.1	10.2	4.2	10.1	4.3
	-18.8	-19	10.4	3.7	10.4	3.9	10.4	4.0	10.4	4.1	10.3	4.2	10.3	4.4
	-16.7	-17	10.8	3.8	10.8	4.0	10.9	4.1	10.7	4.2	10.7	4.3	10.7	4.5
	-13.7	-15	11.3	3.9	11.2	4.1	11.2	4.3	11.2	4.3	11.2	4.4	11.1	4.6
	-11.8	-13	11.7	4.1	11.7	4.2	11.7	4.4	11.7	4.5	11.6	4.5	11.6	4.7
	-9.8	-11	12.3	4.2	12.2	4.3	12.2	4.5	12.2	4.6	12.2	4.6	12.2	4.8
	-9.5	-10	12.6	4.3	12.6	4.4	12.5	4.5	12.5	4.6	12.5	4.7	12.4	4.8
	-8.5	-9.1	12.9	4.3	12.8	4.5	12.8	4.6	12.7	4.7	12.7	4.7	12.7	4.3
	-7	-7.6	13.3	4.4	13.3	4.5	13.3	4.7	13.3	4.8	13.3	4.8	13.2	5.0
	-5	-5.6	14.0	4.5	14.0	4.7	13.9	4.8	13.9	4.9	13.9	4.9	13.9	5.1
	-3	-3.7	14.7	4.7	14.7	4.8	14.6	4.9	14.6	5.0	14.6	5.0	14.6	5.2
	0	-0.7	15.8	4.8	15.8	4.9	15.8	5.1	15.8	5.1	15.8	5.2	15.3	5.1
	3	2.2	17.1	5.0	17.1	5.1	17.1	5.2	17.0	5.3	16.5	5.0	15.3	4.6
	5	4.1	18.0	5.1	18.0	5.2	17.6	5.1	17.0	4.9	16.5	4.7	15.3	4.3
	7	6	18.9	5.2	18.7	5.2	17.6	4.8	17.0	4.6	16.5	4.5	15.3	4.1
9	7.9	19.9	5.3	18.7	4.9	17.6	4.5	17.0	4.4	16.5	4.2	15.3	3.9	
11	9.8	19.9	5.0	18.7	4.6	17.6	4.3	17.0	4.1	16.5	3.9	15.3	3.6	
13	11.8	19.9	4.6	18.7	4.3	17.6	4.0	17.0	3.9	16.5	3.7	15.3	3.4	
15	13.7	19.9	4.1	18.7	4.1	17.6	3.8	17.0	3.6	16.5	3.5	15.3	3.2	

Combination (%) (Capacity index)	Outdoor Air temperature (° C DB)		Indoor temperature(° C WB)											
			16		18		20		21		22		24	
	° C DB	° C WB	TC kW	PI kW	TC kW	PI kW	TC kW	PI kW	TC kW	PI kW	TC kW	PI kW	TC kW	PI kW
100%	-19.8	-20	10.2	3.9	10.2	4.1	10.2	4.2	10.1	4.3	10.1	4.4	10.1	4.6
	-18.8	-19	10.4	4.0	10.4	4.1	10.3	4.3	10.3	4.4	10.3	4.5	10.3	4.6
	-16.7	-17	10.8	4.1	10.7	4.2	10.7	4.4	10.7	4.5	10.7	4.5	10.7	4.7
	-13.7	-15	11.2	4.2	11.2	4.3	11.1	4.5	11.1	4.6	11.1	4.6	11.1	4.8
	-11.8	-13	11.7	4.3	11.7	4.5	11.6	4.6	11.6	4.7	11.6	4.7	11.6	4.9
	-9.8	-11	12.2	4.4	12.2	4.6	12.2	4.7	12.2	4.8	12.1	4.8	12.1	5.0
	-9.5	-10	12.6	4.5	12.5	4.6	12.5	4.8	12.4	4.8	12.4	4.9	12.4	5.0
	-8.5	-9.1	12.8	4.5	12.7	4.7	12.7	4.8	12.7	4.9	12.7	4.9	12.7	5.1
	-7	-7.6	13.3	4.6	13.3	4.8	13.2	4.9	13.2	5.0	13.2	5.0	13.2	5.1
	-5	-5.6	14.0	4.7	13.9	4.9	13.9	5.0	13.9	5.0	13.9	5.1	13.8	5.2
	-3	-3.7	14.6	4.8	14.6	4.4	14.6	5.1	14.6	5.1	14.6	5.2	14.0	5.0
	0	-0.7	15.8	5.0	15.8	5.1	15.8	5.2	15.5	5.1	15.0	4.9	14.0	4.5
	3	2.2	17.1	5.2	17.0	5.3	16.0	4.9	15.5	4.7	15.0	4.5	14.0	4.1
	5	4.1	17.9	5.3	17.0	4.9	16.0	4.6	15.5	4.4	15.0	4.2	14.0	3.9
	7	6	18.0	5.0	17.0	4.6	16.0	4.3	15.5	4.1	15.0	4.0	14.0	3.7
	9	7.9	18.0	4.7	17.0	4.4	16.0	4.1	15.5	3.8	15.0	3.8	14.0	3.5
11	9.8	18.0	4.4	17.0	4.1	16.0	3.8	15.5	3.7	15.0	3.5	14.0	3.3	
13	11.8	18.0	4.1	17.0	3.9	16.0	3.6	15.5	3.5	15.0	3.3	14.0	3.1	
15	13.7	18.0	3.9	17.0	3.6	16.0	3.4	15.5	3.3	15.0	3.2	14.0	2.9	
90%	-19.8	-20	10.1	4.2	10.1	4.3	10.1	4.5	10.0	4.6	10.0	4.6	10.0	4.8
	-18.8	-19	10.3	4.2	10.3	4.4	10.2	4.5	10.2	4.6	10.2	4.7	10.2	4.8
	-16.7	-17	10.7	4.4	10.6	4.5	10.6	4.6	10.6	4.7	10.6	4.8	10.6	4.9
	-13.7	-15	11.2	4.5	11.1	4.6	11.1	4.7	11.1	4.8	11.1	4.9	11.1	5.0
	-11.8	-13	11.6	4.6	11.6	4.7	11.6	4.8	11.6	4.9	11.6	5.0	11.5	5.1
	-9.8	-11	12.2	4.7	12.2	4.8	12.1	4.9	12.1	5.0	12.1	5.0	12.1	5.2
	-9.5	-10	12.5	4.7	12.4	4.8	12.4	5.0	12.4	5.0	12.4	5.1	12.4	5.2
	-8.5	-9.1	12.7	4.8	12.7	4.9	12.7	5.0	12.7	5.1	12.7	5.1	12.5	5.2
	-7	-7.6	13.2	4.8	13.2	5.0	13.1	5.1	13.1	5.1	13.1	5.2	12.5	4.9
	-5	-5.6	13.9	5.0	13.8	5.1	13.8	5.2	13.8	5.2	13.4	5.1	12.5	4.6
	-3	-3.7	14.6	5.1	14.6	5.2	14.4	5.2	13.9	5.0	13.4	4.8	12.5	4.4
	0	-0.7	15.8	5.2	15.3	5.1	14.4	4.7	13.9	4.5	13.4	4.3	12.5	4.0
	3	2.2	16.2	5.0	15.3	4.6	14.4	4.3	13.9	4.1	13.4	4.0	12.5	3.6
	5	4.1	16.2	4.7	15.3	4.3	14.4	4.0	13.9	3.9	13.4	3.7	12.5	3.4
	7	6	16.2	4.4	15.3	4.1	14.4	3.8	13.9	3.7	13.4	3.5	12.5	3.2
	9	7.9	16.2	4.1	15.3	3.8	14.4	3.6	13.9	3.5	13.4	3.3	12.5	3.1
11	9.8	16.2	3.9	15.3	3.6	14.4	3.4	13.9	3.3	13.4	3.1	12.5	2.9	
13	11.8	16.2	3.7	15.3	3.4	14.4	3.2	13.9	3.1	13.4	3.0	12.5	2.7	
15	13.7	16.2	3.5	15.3	3.2	14.4	3.0	13.9	2.9	13.4	2.8	12.5	2.6	
80%	-19.8	-20	10.1	4.5	10.1	4.6	10.1	4.8	10.1	4.8	10.0	4.9	10.0	5.0
	-18.8	-19	10.3	4.5	10.3	4.7	10.2	4.8	10.2	4.9	10.2	4.9	10.2	5.1
	-16.7	-17	10.7	4.6	10.6	4.7	10.6	4.9	10.6	4.9	10.6	5.0	10.6	5.1
	-13.7	-15	11.1	4.7	11.1	4.8	11.1	5.0	11.1	5.0	11.0	5.1	11.0	5.2
	-11.8	-13	11.6	4.8	11.6	4.9	11.5	5.0	11.5	5.1	11.5	5.2	11.2	5.0
	-9.8	-11	12.1	4.9	12.1	5.0	12.1	5.1	12.1	5.2	12.0	5.2	11.2	4.7
	-9.5	-10	12.4	5.0	12.4	5.1	12.4	5.2	12.4	5.2	12.0	5.0	11.2	4.6
	-8.5	-9.1	12.7	5.0	11.8	5.1	12.6	5.2	12.4	5.1	12.0	4.9	11.2	4.5
	-7	-7.6	13.2	5.1	13.2	5.2	12.8	5.1	12.4	4.9	12.0	4.7	11.2	4.3
	-5	-5.6	13.9	5.2	13.6	5.1	12.8	4.8	12.4	4.6	12.0	4.4	11.2	4.0
	-3	-3.7	14.4	5.2	13.6	4.8	12.8	4.5	12.4	4.3	12.0	4.1	11.2	3.8
	0	-0.7	14.4	4.7	13.6	4.4	12.8	4.1	12.4	3.9	12.0	3.8	11.2	3.5
	3	2.2	14.4	4.3	13.6	4.0	12.8	3.7	12.4	3.6	12.0	3.5	11.2	3.2
	5	4.1	14.4	4.0	13.6	3.8	12.8	3.5	12.4	3.4	12.0	3.3	11.2	3.0
	7	6	14.4	3.8	13.6	3.6	12.8	3.3	12.4	3.2	12.0	3.1	11.2	2.9
	9	7.9	14.4	3.6	13.6	3.4	12.8	3.1	12.4	3.0	12.0	2.9	11.2	2.7
11	9.8	14.4	3.4	13.6	3.2	12.8	3.0	12.4	2.9	12.0	2.8	11.2	2.6	
13	11.8	14.4	3.2	13.6	3.0	12.8	2.8	12.4	2.7	12.0	2.6	11.2	2.4	
15	13.7	14.4	3.0	13.6	2.8	12.8	2.7	12.4	2.6	12.0	2.5	11.2	2.3	

# VNMF Mini VRF 50/60Hz

Combination (%) (Capacity index)	Outdoor Air temperature (° C DB)		Indoor temperature(° C WB)											
			16		18		20		21		22		24	
	° C DB	° C WB	TC kW	PI kW	TC kW	PI kW	TC kW	PI kW	TC kW	PI kW	TC kW	PI kW	TC kW	PI kW
70%	-19.8	-20	10.0	4.8	10.0	4.9	10.0	5.0	10.0	5.1	10.0	5.1	9.7	5.1
	-18.8	-19	10.2	4.8	10.2	4.9	10.1	5.0	10.1	5.1	10.1	5.2	9.7	5.0
	-16.7	-17	10.6	4.9	10.6	5.0	10.5	5.1	10.5	5.2	10.4	4.6	9.7	4.7
	-13.7	-15	11.0	5.0	11.0	5.1	11.0	5.2	10.8	5.1	10.4	4.9	9.7	4.5
	-11.8	-13	11.5	5.1	11.5	5.2	11.2	5.0	10.8	4.8	10.4	4.7	9.7	4.3
	-9.8	-11	12.1	5.1	11.9	5.1	11.2	4.8	10.8	4.6	10.4	4.4	9.7	4.0
	-9.5	-10	12.4	5.2	11.9	5.0	11.2	4.6	10.8	4.4	10.4	4.3	9.7	3.9
	-8.5	-9.1	12.6	5.2	11.9	4.9	11.2	4.5	10.8	4.3	10.4	4.2	9.7	3.8
	-7	-7.6	12.6	5.0	11.9	4.6	11.2	4.3	10.8	4.1	10.4	4.0	9.7	3.7
	-5	-5.6	12.6	4.7	11.9	4.4	11.2	4.1	10.8	3.9	10.4	4.6	9.7	3.5
	-3	-3.7	12.6	4.4	11.9	4.1	11.2	3.8	10.8	3.7	10.4	3.5	9.7	3.3
	0	-0.7	12.6	4.0	11.9	3.8	11.2	3.5	10.8	3.4	10.4	3.2	9.7	3.0
	3	2.2	12.6	3.7	11.9	3.4	11.2	3.2	10.8	3.1	10.4	3.0	9.7	2.7
	5	4.1	12.6	3.5	11.9	3.2	11.2	3.0	10.8	2.9	10.4	2.8	9.7	2.6
	7	6	12.6	3.3	11.9	3.1	11.2	2.9	10.8	2.8	10.4	2.7	9.7	2.5
	9	7.9	12.6	3.1	11.9	2.9	11.2	2.7	10.8	2.6	10.4	2.5	9.7	2.3
11	9.8	12.6	2.9	11.9	2.7	11.2	2.6	10.8	2.5	10.4	2.4	9.7	2.2	
13	11.8	12.6	2.8	11.9	2.6	11.2	2.4	10.8	2.3	10.4	2.3	9.7	2.1	
15	13.7	12.6	2.6	11.9	2.5	11.2	2.3	10.8	2.2	10.4	2.2	9.7	2.0	
60%	-19.8	-20	10.0	5.1	10.0	5.2	9.6	5.0	9.3	4.8	9.0	4.6	8.4	4.2
	-18.8	-19	10.2	5.1	10.2	5.2	9.6	4.9	9.3	4.7	9.0	4.5	8.4	4.1
	-16.7	-17	10.6	5.2	10.2	5.0	9.6	4.6	9.3	4.5	9.0	4.3	8.4	3.9
	-13.7	-15	10.8	5.1	10.2	4.8	9.6	4.4	9.3	4.2	9.0	4.1	8.4	3.7
	-11.8	-13	10.8	4.8	10.2	4.5	9.6	4.2	9.3	4.0	9.0	3.9	8.4	3.6
	-9.8	-11	10.8	4.6	10.2	4.3	9.6	4.0	9.3	3.8	9.0	3.7	8.4	3.4
	-9.5	-10	10.8	4.4	10.2	4.1	9.6	3.8	9.3	3.7	9.0	3.6	8.4	3.3
	-8.5	-9.1	10.8	4.3	10.2	4.0	9.6	3.8	9.3	3.6	9.0	3.5	8.4	3.2
	-7	-7.6	10.8	4.1	10.2	3.9	9.6	3.6	9.3	3.5	9.0	3.3	8.4	3.1
	-5	-5.6	10.8	3.9	10.2	3.6	9.6	3.4	9.3	3.3	9.0	3.1	8.4	2.9
	-3	-3.7	10.8	3.7	10.2	3.4	9.6	3.2	9.3	3.1	9.0	3.0	8.4	2.7
	0	-0.7	10.8	3.4	10.2	3.2	9.6	2.9	9.3	2.8	9.0	2.7	8.4	2.5
	3	2.2	10.8	3.1	10.2	2.9	9.6	2.7	9.3	2.6	9.0	2.5	8.4	2.3
	5	4.1	10.8	2.9	10.2	2.7	9.6	2.6	9.3	2.5	9.0	2.4	8.4	2.2
	7	6	10.8	2.8	10.2	2.6	9.6	2.4	9.3	2.3	9.0	2.3	8.4	2.1
	9	7.9	10.8	2.6	10.2	2.5	9.6	2.3	9.3	2.2	9.0	2.2	8.4	2.0
11	9.8	10.8	2.5	10.2	2.3	9.6	2.2	9.3	2.1	9.0	2.0	8.4	1.9	
13	11.8	10.8	2.3	10.2	2.2	9.6	2.1	9.3	2.0	9.0	1.9	8.4	1.8	
15	13.7	10.8	2.2	10.2	2.1	9.6	2.0	9.3	1.9	9.0	1.9	8.4	1.7	
50%	-19.8	-20	9.0	4.6	8.5	4.3	8.0	4.0	7.7	3.8	7.4	3.7	6.9	3.4
	-18.8	-19	9.0	4.5	8.5	4.2	8.0	3.9	7.7	3.8	7.4	3.6	6.9	3.3
	-16.7	-17	9.0	4.3	8.5	4.0	8.0	3.7	7.7	3.6	7.4	3.5	6.9	3.2
	-13.7	-15	9.0	4.1	8.5	3.8	8.0	3.6	7.7	3.4	7.4	3.3	6.9	3.0
	-11.8	-13	9.0	3.9	8.5	3.6	8.0	3.4	7.7	3.3	7.4	3.1	6.9	2.9
	-9.8	-11	9.0	3.7	8.5	3.4	8.0	3.2	7.7	3.1	7.4	3.0	6.9	2.8
	-9.5	-10	9.0	3.6	8.5	3.3	8.0	3.1	7.7	3.0	7.4	2.9	6.9	2.7
	-8.5	-9.1	9.0	3.5	8.5	3.3	8.0	3.0	7.7	2.9	7.4	2.8	6.9	2.6
	-7	-7.6	9.0	3.3	8.5	3.1	8.0	2.9	7.7	2.8	7.4	2.7	6.9	2.5
	-5	-5.6	9.0	3.2	8.5	3.0	8.0	2.8	7.7	2.7	7.4	2.6	6.9	2.4
	-3	-3.7	9.0	3.0	8.5	2.8	8.0	2.6	7.7	2.5	7.4	2.4	6.9	2.3
	0	-0.7	9.0	2.7	8.5	2.6	8.0	2.4	7.7	2.3	7.4	2.3	6.9	2.1
	3	2.2	9.0	2.5	8.5	2.4	8.0	2.2	7.7	2.2	7.4	2.1	6.9	1.9
	5	4.1	9.0	2.4	8.5	2.3	8.0	2.1	7.7	2.0	7.4	2.0	6.9	1.9
	7	6	9.0	2.3	8.5	2.1	8.0	2.0	7.7	2.0	7.4	1.9	6.9	1.8
	9	7.9	9.0	2.2	8.5	2.0	8.0	1.9	7.7	1.9	7.4	1.8	6.9	1.7
11	9.8	9.0	2.1	8.5	1.9	8.0	1.8	7.7	1.8	7.4	1.7	6.9	1.6	
13	11.8	9.0	2.0	8.5	1.8	8.0	1.7	7.7	1.7	7.4	1.6	6.9	1.5	
15	13.7	9.0	1.9	8.5	1.8	8.0	1.7	7.7	1.6	7.4	1.6	6.9	1.5	

VNMF345Q0A-G08V160

TC: Total Capacity (kW); PI: Power Input (kW) (Compressor + Outdoor fan motor)

Combination (%) (Capacity index)	Outdoor Air temperature (° C DB)		Indoor temperature(° C WB)											
			16		18		20		21		22		24	
	° C DB	° C WB	TC kW	PI kW	TC kW	PI kW	TC kW	PI kW	TC kW	PI kW	TC kW	PI kW	TC kW	PI kW
130%	-19.8	-20	12.0	3.6	11.9	3.9	11.9	4.1	11.9	4.3	11.8	4.4	11.8	4.6
	-18.8	-19	12.2	3.7	12.1	4.0	12.1	4.2	12.0	4.3	12.0	4.4	12.0	4.7
	-16.7	-17	12.6	3.9	12.6	4.1	12.5	4.4	12.5	4.5	12.5	4.6	12.4	4.8
	-13.7	-15	13.2	4.0	13.1	4.3	13.0	4.5	13.0	4.6	13.0	4.7	13.0	5.0
	-11.8	-13	13.7	4.2	13.7	4.5	13.6	4.7	13.6	4.8	13.6	4.9	13.5	5.1
	-9.8	-11	14.3	4.4	14.3	4.6	14.2	4.8	14.2	4.9	14.2	5.1	14.2	5.3
	-9.5	-10	14.7	4.5	14.6	4.7	14.6	4.9	14.6	5.0	14.5	5.1	14.5	5.3
	-8.5	-9.1	15.0	4.6	14.9	4.8	14.9	5.0	14.9	5.1	14.9	5.2	14.8	5.4
	-7	-7.6	15.5	4.7	15.5	4.9	15.4	5.1	15.4	5.2	15.4	5.3	15.3	5.5
	-5	-5.6	16.3	4.9	16.3	5.1	16.2	5.3	16.2	5.4	16.1	5.5	16.1	5.6
	-3	-3.7	17.1	5.1	17.0	5.2	17.0	5.4	17.0	5.5	17.0	5.6	16.9	5.8
	0	-0.7	18.4	5.3	18.4	5.5	18.4	5.6	18.4	5.7	18.3	5.8	18.3	6.0
	3	2.2	19.9	5.5	19.8	5.7	19.8	5.8	19.8	5.9	19.8	6.0	19.7	6.1
	5	4.1	20.9	5.7	20.9	5.8	20.9	5.9	20.8	6.0	20.8	6.1	20.7	6.2
	7	6	22.0	5.8	21.9	5.9	21.9	6.1	21.9	6.1	21.9	6.2	21.0	6.0
9	7.9	23.1	5.9	23.0	6.1	23.0	6.2	23.0	6.2	22.5	6.1	21.0	5.6	
11	9.8	24.3	6.0	24.2	6.2	24.1	6.2	23.3	6.0	22.5	5.7	21.0	5.3	
13	11.8	25.6	6.2	25.5	6.3	24.1	5.8	23.3	5.6	22.5	5.4	21.0	4.9	
15	13.7	26.8	6.3	25.6	5.9	24.1	5.5	23.3	5.3	22.5	5.1	21.0	4.7	
120%	-19.8	-20	11.9	4.0	11.9	4.2	11.8	4.4	11.8	4.6	11.8	4.7	11.7	4.9
	-18.8	-19	12.1	4.0	12.0	4.3	12.0	4.5	12.0	4.6	12.0	4.7	11.9	5.0
	-16.7	-17	12.6	4.2	12.5	4.4	12.4	4.6	12.4	4.8	12.4	4.9	12.4	5.1
	-13.7	-15	13.1	4.4	13.0	4.6	13.0	4.8	13.0	4.9	13.0	5.0	12.9	5.2
	-11.8	-13	13.6	4.5	13.6	4.7	13.6	4.9	13.6	5.0	13.5	5.1	13.5	5.4
	-9.8	-11	14.3	4.7	14.2	4.9	14.2	5.1	14.2	5.2	14.2	5.3	14.1	5.5
	-9.5	-10	14.6	4.8	14.6	5.0	14.5	5.2	14.5	5.3	14.5	5.4	14.5	5.5
	-8.5	-9.1	14.9	4.9	14.9	5.0	14.9	5.2	14.8	5.3	14.8	5.4	14.7	5.6
	-7	-7.6	15.4	5.0	15.4	5.2	15.4	5.3	15.4	5.4	15.3	5.5	15.3	5.7
	-5	-5.6	16.3	5.1	16.2	5.3	16.1	5.5	16.1	5.6	16.1	5.7	16.1	5.8
	-3	-3.7	17.0	5.3	17.0	5.5	17.0	5.6	17.0	5.7	16.9	5.8	16.9	5.9
	0	-0.7	18.4	5.5	18.4	5.7	18.3	5.8	18.3	5.9	18.3	6.0	18.3	6.1
	3	2.2	19.8	5.7	19.8	5.9	19.8	6.0	19.7	6.1	19.7	6.2	19.3	6.1
	5	4.1	20.9	5.9	20.8	6.0	20.8	6.1	20.7	6.2	20.7	6.3	19.3	5.7
	7	6	21.9	6.0	21.9	6.1	21.9	6.2	21.5	6.1	20.8	5.9	19.3	5.4
9	7.9	23.0	6.1	23.0	6.2	22.2	6.0	21.5	5.8	20.8	5.5	19.3	5.1	
11	9.8	24.2	6.2	23.6	6.1	22.2	5.7	21.5	5.4	20.8	5.2	19.3	4.8	
13	11.8	25.1	6.1	23.6	5.7	22.2	5.3	21.5	5.1	20.8	4.9	19.3	4.5	
15	13.7	25.1	5.8	23.6	5.4	22.2	5.0	21.5	4.8	20.8	4.6	19.3	4.3	
110%	-19.8	-20	11.9	4.3	11.8	4.5	11.7	4.7	11.7	4.9	11.8	5.0	11.7	5.2
	-18.8	-19	12.0	4.4	12.0	4.6	12.0	4.8	12.0	4.9	11.9	5.0	11.9	5.2
	-16.7	-17	12.5	4.5	12.4	4.7	12.6	4.9	12.4	5.0	12.4	5.1	12.3	5.3
	-13.7	-15	13.0	4.7	13.0	4.9	12.9	5.1	12.9	5.2	12.9	5.3	12.9	5.5
	-11.8	-13	13.6	4.8	13.6	5.0	13.5	5.2	13.5	5.3	13.5	5.4	13.5	5.6
	-9.8	-11	14.2	5.0	14.2	5.2	14.2	5.3	14.1	5.4	14.1	5.5	14.1	5.7
	-9.5	-10	14.6	5.1	14.5	5.2	14.5	5.4	14.5	5.5	14.5	5.6	14.4	5.8
	-8.5	-9.1	14.9	5.1	14.8	5.3	14.8	5.5	14.7	5.6	14.7	5.7	14.7	5.2
	-7	-7.6	15.4	5.2	15.4	5.4	15.3	5.6	15.3	5.7	15.3	5.7	15.3	5.9
	-5	-5.6	16.2	5.4	16.1	5.6	16.1	5.7	16.1	5.8	16.1	5.9	16.0	6.0
	-3	-3.7	17.0	5.5	17.0	5.7	16.9	5.8	16.9	5.9	16.9	6.0	16.9	6.1
	0	-0.7	18.3	5.7	18.3	5.9	18.3	6.0	18.3	6.1	18.3	6.2	17.7	6.0
	3	2.2	19.8	5.9	19.7	6.1	19.7	6.2	19.7	6.2	19.0	6.0	17.7	5.5
	5	4.1	20.8	6.1	20.8	6.2	20.4	6.1	19.7	5.9	19.0	5.6	17.7	5.2
	7	6	21.9	6.2	21.7	6.2	20.4	5.7	19.7	5.5	19.0	5.3	17.7	4.9
9	7.9	23.0	6.3	21.7	5.8	20.4	5.4	19.7	5.2	19.0	5.0	17.7	4.6	
11	9.8	23.0	5.9	21.7	5.5	20.4	5.1	19.7	4.9	19.0	4.7	17.7	4.3	
13	11.8	23.0	5.5	21.7	5.1	20.4	4.8	19.7	4.6	19.0	4.4	17.7	4.1	
15	13.7	23.0	4.9	21.7	4.9	20.4	4.5	19.7	4.3	19.0	4.2	17.7	3.9	

# VNMF Mini VRF 50/60Hz

Combination (%) (Capacity index)	Outdoor Air temperature (° C DB)		Indoor temperature(° C WB)											
			16		18		20		21		22		24	
	° C DB	° C WB	TC kW	PI kW	TC kW	PI kW	TC kW	PI kW	TC kW	PI kW	TC kW	PI kW	TC kW	PI kW
100%	-19.8	-20	11.8	4.7	11.7	4.9	11.7	5.0	11.7	5.1	11.7	5.2	11.6	5.4
	-18.8	-19	12.0	4.7	12.0	4.9	11.9	5.1	11.9	5.2	11.9	5.3	11.9	5.5
	-16.7	-17	12.4	4.9	12.4	5.0	12.4	5.2	12.3	5.3	12.3	5.4	12.3	5.6
	-13.7	-15	13.0	5.0	12.9	5.2	12.9	5.3	12.9	5.4	12.9	5.5	12.8	5.7
	-11.8	-13	13.5	5.1	13.5	5.3	13.5	5.5	13.5	5.6	13.5	5.6	13.4	5.8
	-9.8	-11	14.2	5.3	14.1	5.4	14.1	5.6	14.1	5.7	14.0	5.8	14.0	5.9
	-9.5	-10	14.5	5.3	14.5	5.5	14.5	5.7	14.4	5.7	14.4	5.8	14.3	6.0
	-8.5	-9.1	14.8	5.4	14.7	5.6	14.7	5.7	14.7	5.8	14.7	5.9	14.7	6.0
	-7	-7.6	15.3	5.5	15.3	5.7	15.3	5.8	15.3	5.9	15.3	6.0	15.2	6.1
	-5	-5.6	16.1	5.7	16.1	5.8	16.1	5.9	16.0	6.0	16.0	6.1	16.0	6.2
	-3	-3.7	16.9	5.8	16.9	5.2	16.9	6.1	16.9	6.1	16.9	6.2	16.1	5.9
	0	-0.7	18.3	6.0	18.3	6.1	18.2	6.2	17.9	6.1	17.3	5.9	16.1	5.4
	3	2.2	19.7	6.1	19.7	6.2	18.5	5.8	17.9	5.6	17.3	5.3	16.1	4.9
	5	4.1	20.7	6.2	19.7	5.9	18.5	5.4	17.9	5.2	17.3	5.0	16.1	4.6
	7	6	20.9	5.9	19.7	5.5	18.5	5.1	17.9	4.9	17.3	4.7	16.1	4.4
9	7.9	20.9	5.6	19.7	5.2	18.5	4.8	17.9	4.6	17.3	4.5	16.1	4.1	
11	9.8	20.9	5.2	19.7	4.9	18.5	4.6	17.9	4.4	17.3	4.2	16.1	3.9	
13	11.8	20.9	4.9	19.7	4.6	18.5	4.3	17.9	4.1	17.3	4.0	16.1	3.7	
15	13.7	20.9	4.6	19.7	4.3	18.5	4.0	17.9	3.9	17.3	3.7	16.1	3.5	
90%	-19.8	-20	11.7	5.0	11.7	5.2	11.7	5.4	11.6	5.4	11.6	5.5	11.6	5.7
	-18.8	-19	11.9	5.1	11.9	5.2	11.8	5.4	11.8	5.5	11.8	5.6	11.8	5.8
	-16.7	-17	12.4	5.2	12.3	5.3	12.3	5.5	12.3	5.6	12.3	5.7	12.3	5.8
	-13.7	-15	12.9	5.3	12.8	5.5	12.8	5.6	12.8	5.7	12.8	5.8	12.8	5.9
	-11.8	-13	13.4	5.4	13.4	5.6	13.4	5.7	13.4	5.8	13.4	5.9	13.3	6.0
	-9.8	-11	14.1	5.6	14.1	5.7	14.0	5.8	14.0	5.9	14.0	6.0	14.0	6.2
	-9.5	-10	14.4	5.6	14.4	5.8	14.4	5.9	14.3	6.0	14.3	6.1	14.3	6.2
	-8.5	-9.1	14.7	5.7	14.7	5.8	14.7	6.0	14.7	6.0	14.7	6.1	14.5	6.2
	-7	-7.6	15.2	5.8	15.2	5.9	15.2	6.1	15.2	6.1	15.2	6.2	14.5	5.9
	-5	-5.6	16.1	5.9	16.0	6.0	16.0	6.2	15.9	6.2	15.5	6.0	14.5	5.5
	-3	-3.7	16.8	6.0	16.8	6.1	16.7	6.2	16.1	5.9	15.5	5.7	14.5	5.2
	0	-0.7	18.2	6.2	17.7	6.0	16.7	5.6	16.1	5.4	15.5	5.2	14.5	4.7
	3	2.2	18.8	5.9	17.7	5.5	16.7	5.1	16.1	4.9	15.5	4.7	14.5	4.3
	5	4.1	18.8	5.5	17.7	5.2	16.7	4.8	16.1	4.6	15.5	4.4	14.5	4.1
	7	6	18.8	5.2	17.7	4.9	16.7	4.5	16.1	4.4	15.5	4.2	14.5	3.9
9	7.9	18.8	4.9	17.7	4.6	16.7	4.3	16.1	4.1	15.5	4.0	14.5	3.6	
11	9.8	18.8	4.6	17.7	4.3	16.7	4.0	16.1	3.9	15.5	3.7	14.5	3.5	
13	11.8	18.8	4.4	17.7	4.1	16.7	3.8	16.1	3.7	15.5	3.5	14.5	3.3	
15	13.7	18.8	4.1	17.7	3.9	16.7	3.6	16.1	3.5	15.5	3.3	14.5	3.1	
80%	-19.8	-20	11.7	5.3	11.6	5.5	11.6	5.7	11.6	5.7	11.6	5.8	11.6	6.0
	-18.8	-19	11.9	5.4	11.9	5.5	11.8	5.7	11.8	5.8	11.8	5.9	11.7	6.0
	-16.7	-17	12.3	5.5	12.3	5.7	12.3	5.8	12.3	5.9	12.3	5.9	12.2	6.1
	-13.7	-15	12.9	5.6	12.8	5.8	12.8	5.9	12.8	6.0	12.7	6.0	12.7	6.2
	-11.8	-13	13.4	5.7	13.4	5.9	13.3	6.0	13.3	6.1	13.3	6.1	12.9	6.0
	-9.8	-11	14.0	5.8	14.0	6.0	14.0	6.1	14.0	6.2	13.9	6.2	12.9	5.6
	-9.5	-10	14.4	5.9	14.3	6.0	14.3	6.2	14.3	6.2	13.9	6.0	12.9	5.5
	-8.5	-9.1	14.7	6.0	13.6	6.1	14.6	6.2	14.3	6.1	13.9	5.8	12.9	5.3
	-7	-7.6	15.2	6.0	15.2	6.2	14.8	6.0	14.3	5.8	13.9	5.6	12.9	5.1
	-5	-5.6	16.0	6.2	15.7	6.1	14.8	5.7	14.3	5.4	13.9	5.2	12.9	4.8
	-3	-3.7	16.7	6.2	15.7	5.8	14.8	5.3	14.3	5.1	13.9	4.9	12.9	4.5
	0	-0.7	16.7	5.6	15.7	5.2	14.8	4.9	14.3	4.7	13.9	4.5	12.9	4.1
	3	2.2	16.7	5.1	15.7	4.8	14.8	4.4	14.3	4.3	13.9	4.1	12.9	3.8
	5	4.1	16.7	4.8	15.7	4.5	14.8	4.2	14.3	4.0	13.9	3.9	12.9	3.6
	7	6	16.7	4.5	15.7	4.2	14.8	4.0	14.3	3.8	13.9	3.7	12.9	3.4
9	7.9	16.7	4.3	15.7	4.0	14.8	3.7	14.3	3.6	13.9	3.5	12.9	3.2	
11	9.8	16.7	4.0	15.7	3.8	14.8	3.5	14.3	3.4	13.9	3.3	12.9	3.0	
13	11.8	16.7	3.8	15.7	3.6	14.8	3.3	14.3	3.2	13.9	3.1	12.9	2.9	
15	13.7	16.7	3.6	15.7	3.4	14.8	3.2	14.3	3.0	13.9	2.9	12.9	2.7	

Combination (%) (Capacity index)	Outdoor Air temperature (° C DB)		Indoor temperature (° C WB)											
			16		18		20		21		22		24	
	° C DB	° C WB	TC kW	PI kW	TC kW	PI kW	TC kW	PI kW	TC kW	PI kW	TC kW	PI kW	TC kW	PI kW
70%	-19.8	-20	11.6	5.7	11.5	5.8	11.5	6.0	11.5	6.0	11.5	6.1	11.3	6.0
	-18.8	-19	11.8	5.7	11.8	5.9	11.7	6.0	11.7	6.1	11.7	6.1	11.3	5.9
	-16.7	-17	12.2	5.8	12.2	6.0	12.2	6.1	12.2	6.2	12.1	5.5	11.3	5.6
	-13.7	-15	12.8	5.9	12.7	6.1	12.7	6.2	12.5	6.1	12.1	5.8	11.3	5.4
	-11.8	-13	13.3	6.0	13.3	6.2	13.0	6.0	12.5	5.8	12.1	5.5	11.3	5.1
	-9.8	-11	14.0	6.1	13.8	6.1	13.0	5.7	12.5	5.5	12.1	5.2	11.3	4.8
	-9.5	-10	14.3	6.2	13.8	5.9	13.0	5.5	12.5	5.3	12.1	5.1	11.3	4.7
	-8.5	-9.1	14.6	6.2	13.8	5.8	13.0	5.4	12.5	5.2	12.1	4.9	11.3	4.6
	-7	-7.6	14.6	5.9	13.8	5.5	13.0	5.1	12.5	4.9	12.1	4.7	11.3	4.4
	-5	-5.6	14.6	5.6	13.8	5.2	13.0	4.8	12.5	4.6	12.1	5.5	11.3	4.1
	-3	-3.7	14.6	5.2	13.8	4.9	13.0	4.6	12.5	4.4	12.1	4.2	11.3	3.9
	0	-0.7	14.6	4.8	13.8	4.5	13.0	4.2	12.5	4.0	12.1	3.9	11.3	3.6
	3	2.2	14.6	4.4	13.8	4.1	13.0	3.8	12.5	3.7	12.1	3.5	11.3	3.3
	5	4.1	14.6	4.1	13.8	3.9	13.0	3.6	12.5	3.5	12.1	3.3	11.3	3.1
	7	6	14.6	3.9	13.8	3.6	13.0	3.4	12.5	3.3	12.1	3.2	11.3	2.9
	9	7.9	14.6	3.7	13.8	3.5	13.0	3.2	12.5	3.1	12.1	3.0	11.3	2.8
11	9.8	14.6	3.5	13.8	3.3	13.0	3.1	12.5	3.0	12.1	2.9	11.3	2.7	
13	11.8	14.6	3.3	13.8	3.1	13.0	2.9	12.5	2.8	12.1	2.7	11.3	2.5	
15	13.7	14.6	3.1	13.8	2.9	13.0	2.7	12.5	2.7	12.1	2.6	11.3	2.4	
60%	-19.8	-20	11.6	6.0	11.5	6.2	11.1	5.9	10.8	5.7	10.4	5.5	9.7	5.0
	-18.8	-19	11.7	6.1	11.7	6.2	11.1	5.8	10.8	5.6	10.4	5.3	9.7	4.9
	-16.7	-17	12.2	6.2	11.8	6.0	11.1	5.5	10.8	5.3	10.4	5.1	9.7	4.7
	-13.7	-15	12.5	6.1	11.8	5.7	11.1	5.2	10.8	5.1	10.4	4.9	9.7	4.5
	-11.8	-13	12.5	5.8	11.8	5.4	11.1	5.0	10.8	4.8	10.4	4.6	9.7	4.3
	-9.8	-11	12.5	5.4	11.8	5.1	11.1	4.7	10.8	4.5	10.4	4.4	9.7	4.0
	-9.5	-10	12.5	5.3	11.8	4.9	11.1	4.6	10.8	4.4	10.4	4.2	9.7	3.9
	-8.5	-9.1	12.5	5.2	11.8	4.8	11.1	4.5	10.8	4.3	10.4	4.1	9.7	3.8
	-7	-7.6	12.5	4.9	11.8	4.6	11.1	4.3	10.8	4.1	10.4	4.0	9.7	3.7
	-5	-5.6	12.5	4.6	11.8	4.3	11.1	4.0	10.8	3.9	10.4	3.7	9.7	3.5
	-3	-3.7	12.5	4.4	11.8	4.1	11.1	3.8	10.8	3.7	10.4	3.5	9.7	3.3
	0	-0.7	12.5	4.0	11.8	3.7	11.1	3.5	10.8	3.4	10.4	3.3	9.7	3.0
	3	2.2	12.5	3.7	11.8	3.4	11.1	3.2	10.8	3.1	10.4	3.0	9.7	2.8
	5	4.1	12.5	3.5	11.8	3.3	11.1	3.0	10.8	2.9	10.4	2.8	9.7	2.6
	7	6	12.5	3.3	11.8	3.1	11.1	2.9	10.8	2.8	10.4	2.7	9.7	2.5
	9	7.9	12.5	3.1	11.8	2.9	11.1	2.7	10.8	2.7	10.4	2.6	9.7	2.4
11	9.8	12.5	3.0	11.8	2.8	11.1	2.6	10.8	2.5	10.4	2.4	9.7	2.3	
13	11.8	12.5	2.8	11.8	2.6	11.1	2.5	10.8	2.4	10.4	2.3	9.7	2.2	
15	13.7	12.5	2.7	11.8	2.5	11.1	2.4	10.8	2.3	10.4	2.2	9.7	2.1	
50%	-19.8	-20	10.4	5.5	9.8	5.1	9.3	4.7	8.9	4.6	8.6	4.4	8.0	4.0
	-18.8	-19	10.4	5.4	9.8	5.0	9.3	4.7	8.9	4.5	8.6	4.3	8.0	4.0
	-16.7	-17	10.4	5.1	9.8	4.8	9.3	4.4	8.9	4.3	8.6	4.1	8.0	3.8
	-13.7	-15	10.4	4.9	9.8	4.6	9.3	4.2	8.9	4.1	8.6	3.9	8.0	3.6
	-11.8	-13	10.4	4.6	9.8	4.3	9.3	4.0	8.9	3.9	8.6	3.7	8.0	3.5
	-9.8	-11	10.4	4.4	9.8	4.1	9.3	3.8	8.9	3.7	8.6	3.6	8.0	3.3
	-9.5	-10	10.4	4.3	9.8	4.0	9.3	3.7	8.9	3.6	8.6	3.5	8.0	3.2
	-8.5	-9.1	10.4	4.2	9.8	3.9	9.3	3.6	8.9	3.5	8.6	3.4	8.0	3.1
	-7	-7.6	10.4	4.0	9.8	3.7	9.3	3.5	8.9	3.4	8.6	3.2	8.0	3.0
	-5	-5.6	10.4	3.8	9.8	3.5	9.3	3.3	8.9	3.2	8.6	3.1	8.0	2.8
	-3	-3.7	10.4	3.6	9.8	3.3	9.3	3.1	8.9	3.0	8.6	2.9	8.0	2.7
	0	-0.7	10.4	3.3	9.8	3.1	9.3	2.9	8.9	2.8	8.6	2.7	8.0	2.5
	3	2.2	10.4	3.0	9.8	2.8	9.3	2.7	8.9	2.6	8.6	2.5	8.0	2.3
	5	4.1	10.4	2.9	9.8	2.7	9.3	2.5	8.9	2.4	8.6	2.4	8.0	2.2
	7	6	10.4	2.7	9.8	2.6	9.3	2.4	8.9	2.3	8.6	2.2	8.0	2.1
	9	7.9	10.4	2.6	9.8	2.4	9.3	2.3	8.9	2.2	8.6	2.1	8.0	2.0
11	9.8	10.4	2.4	9.8	2.3	9.3	2.2	8.9	2.1	8.6	2.0	8.0	1.9	
13	11.8	10.4	2.3	9.8	2.2	9.3	2.1	8.9	2.0	8.6	1.9	8.0	1.8	
15	13.7	10.4	2.2	9.8	2.1	9.3	2.0	8.9	1.9	8.6	1.9	8.0	1.7	

Note:

1. [ ] is tested under our standard condition.
2. In heating mode, avoid running the unit when the outdoor air temperature is below -15 degrees.
3. The above table shows the average value of conditions may operate.

## 8. Electric Characteristics

Capacity (kW)	Power Supply	Power Line (mm <sup>2</sup> )	Breaker/Fuse (A)	Signal Wire between Indoor and Outdoor Units (mm)
8/10	220-240V 50Hz/60Hz	3 × 4.0	40/30	three-core shielded cable 3 × 1.0
12.5/14/16	220-240V 50Hz/60Hz	3 × 6.0	63/45	



9. Sound Levels

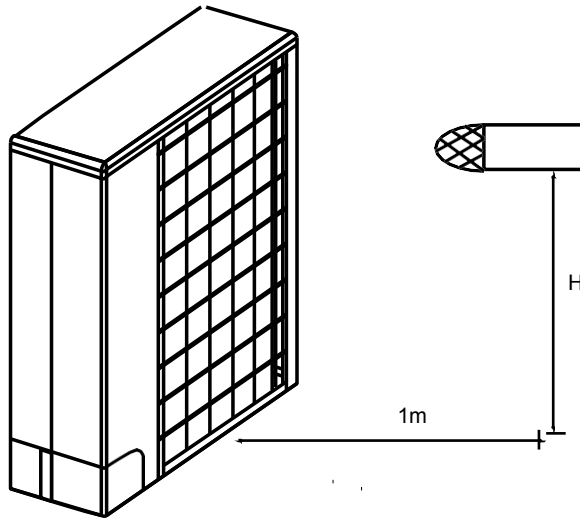

Model	Sound level dB(A)	Height (m)
VNMF002Q0A-G04V080	54	1
VNMF253Q0A-G05V100	56	1
VNMF003Q0A-G06V125	56	1
VNMF004Q0A-G07V140	57	1
VNMF345Q0A-G08V160	57	1

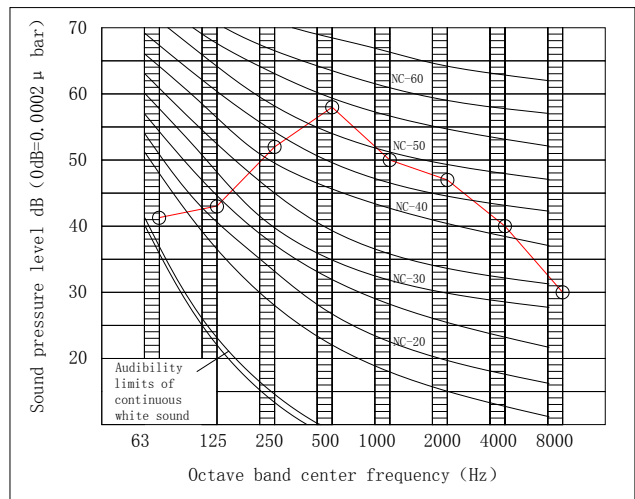
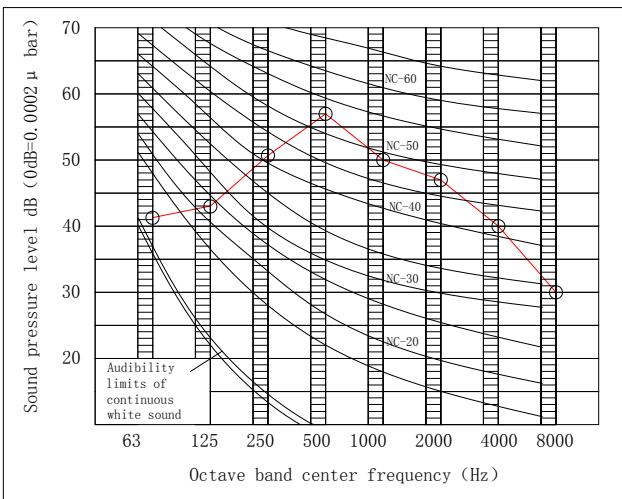

10. Operation Limits

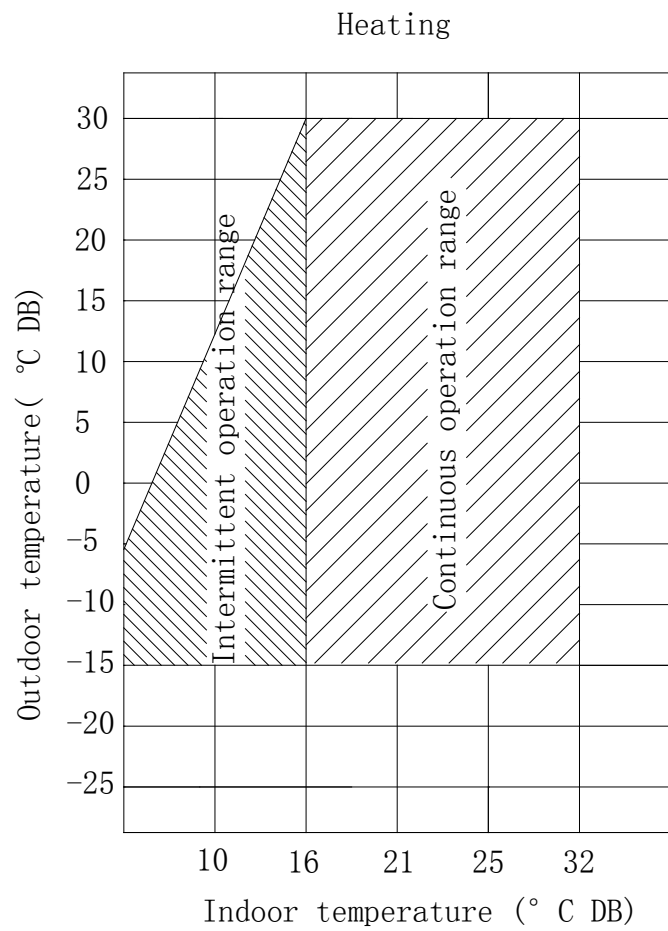
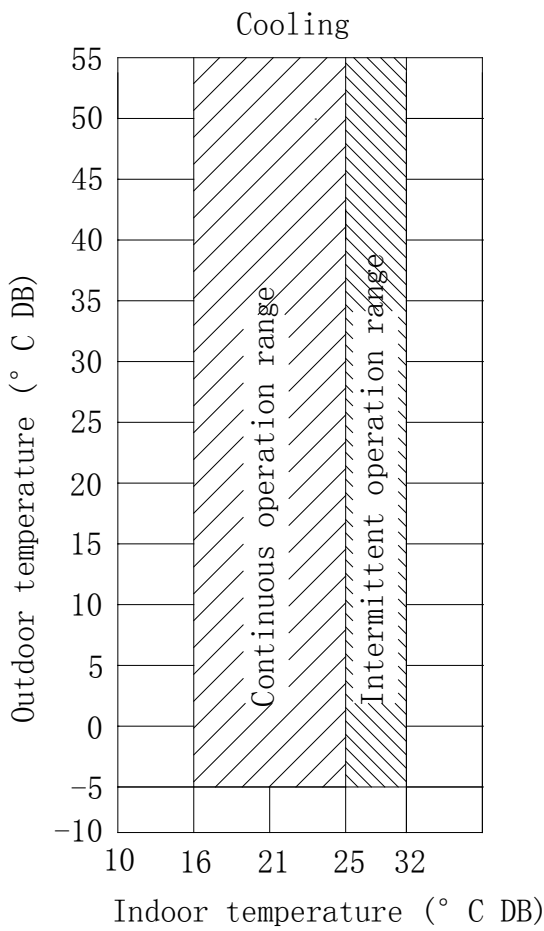

Operation mode	Outdoor temperature	Indoor temperature
Cooling	-5°C - 55°C	16°C - 32°C
Heating	-15°C - 30°C	16°C - 32°C

# Part 3

# Installation

1	Precautions .....	66
2	Outdoor Unit Installation .....	67
3	Piping Installation .....	68
4	Electric Wiring Installations .....	76
5	Test Running .....	78
6	Precautions on Refrigerant Leakage .....	79

## 1. Precautions

### 1.1 This air conditioner is a comfort unit. Don't use it in some special places for machine rooms, precise instruments, foods, plants, animals, artworks, etc.

- (1) The installation shall be done by the distributor or the professional staff. The installation staff must have related professional knowledge. Misoperation in the self-installation will result in fire, electric shock, injury, water leak, etc.
- (2) If the air conditioner is installed in a small room, some proper measures shall be taken to make sure that the concentration of refrigerant leak in the room shall not exceed the critical level. For detailed measures, please consult the distributor.
- (3) When connecting the power supply, comply with the regulations specified by the local power company. According to the law, the ground wire must be connected. The misconnection of the ground wire will result in electric shock.
- (4) If the air conditioner needs to be moved or reinstalled, please inform the distributor or the professional staff to operate. Incorrect installation will result in fire, electric shock, injury, water leak, etc.
- (5) The users are not permitted to rebuild or repair the air conditioner by their own. Incorrect repair will result in fire, electric shock, injury, water leak, etc.. Please inform the distributor or the professional staff to repair.

### 1.2 NOTE

- (1) Make sure the water drainage ditch is useable.
- (2) Make sure a current leakage protection switch is equipped. The current leakage protection switch must be equipped. If not, an electric shock will take place.
- (3) It mustn't be installed in any potential leakage location of inflammable gas. In case of the inflammable gas leak around the outdoor unit, a fire takes place.
- (4) Make sure the foundation and hoisting are firm and reliable. If not, it will result in a falling accident.
- (5) Make sure all cables are correctly connected. The misconnection of the cables will result in the damage of electrical components.
- (6) Pre-installation exposure to water or other moistures will result in short circuit of its electrical components.. Don't store it in any damp cellar or expose it to rain or water.
- (7) In case of the refrigerant leaks during installation, the room must be ventilated at once. If the leaked refrigerant is exposed to flame, some toxic gases will be generated.
- (8) After installation, make sure the refrigerant is not leaked.
- (9) If the refrigerant gas in the room is exposed to flame source, such as a heater, a stove or an electric cooker, some toxic gases will be generated..
- (10) A lightning protection device must be equipped according to national laws and regulations against the lightning strike.

## 2. Outdoor Unit Installation

### 2.1 Installation space selection

(1) Install the outdoor unit at a place where discharge air is not blocked. When an outdoor unit is installed in a place that is always exposed. There also should be enough space for installation and maintenance.

(2) To a strong wind like a coast or on the high store of a building, secure a normal fan operation by using a duct or a wind shield.

(3) When installing the outdoor unit in a place that is constantly exposed to a strong wind such as the upper stairs or rooftop of a building, apply the windproof measures referring to the following examples.

(4) Install the unit so that its discharge port faces to the wall of the building. Keep a distance 2000mm or more between the unit and the wall surface.

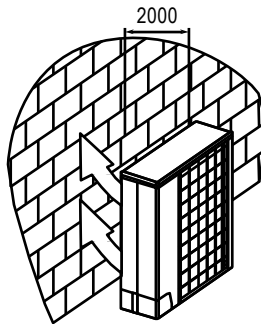

(5) Supposing the wind direction during the operation season of the discharge port is set at right angle to the wind direction.

(6) Do not install the unit in a place full of machine oil.

(7) Do not install the unit in a place where high-frequency radio waves are likely to be.

### 2.2 Hoisting of outdoor unit

(1) Don't remove any package upon hoisting. Two ropes (more than 8cm) shall be used to hoist the well-packaged machine stably and safely. If there is no package or the packaging material is broken, use some backing plates or packaging materials to protect the machine.

(2) The outdoor unit shall be carried and hoisted vertically, within an inclination of less than 15 degrees. Care should be taken to safety during carrying and hoisting the machine.

(3) The gravity of the machine is not in the center, so be careful to hoist the machine.

(4) Don't hold the suction inlet of the housing, or it will be deformed.

## 3. Piping Installation

### 3.1 Piping connection

#### (1) Flaring

Use a pipe cutter to cut the refrigerant pipe and a pipe expander to flare

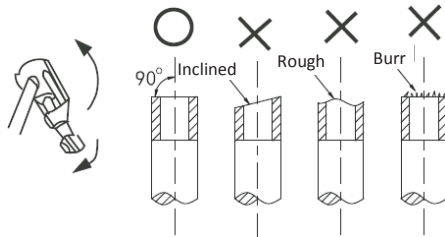

Outer Diameter (mm)	A(mm)	
	Maximum	Minimum
Φ6.35	8.7	8.3
Φ9.52	12.4	12.0
Φ12.7	15.8	15.4
Φ15.88	19.0	18.6

#### 2) Fastening nut

Align the connecting pipe, tighten it by hand, and then by a wrench.

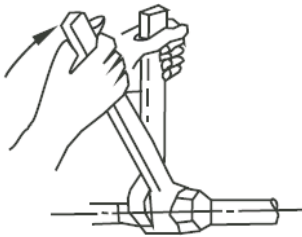

Pipe Dimension (mm)	Tightening Torque (Nm)
Φ6.35	14.2~17.2(144~176 kgf•cm)
Φ9.52	32.7~39.9(333~407 kgf•cm)
Φ12.7	49.5~60.3(504~616 kgf•cm)
Φ15.88	61.8~75.4(630~770 kgf•cm)

### 3.2 Set refrigerant pipe dimension and pipe connecting steps

Name of Pipes	Connecting Position of Pipe	Code
Main pipe	Pipe between the outdoor unit and the first distributor at the indoor unit side	L <sub>1</sub>
Main pipe of indoor unit	Pipe behind the first distributor at the indoor side and indirectly connected to the indoor unit	L <sub>2</sub> ,L <sub>5</sub>
Branch pipe of indoor unit	Pipe behind the distributor and directly connected to the indoor unit	A,b,c,d,e,f
Distributor components of indoor unit	Pipe components to connect the main pipe, main branch pipe and branch pipe	A,B,C,D,E

(1) Connecting mode I

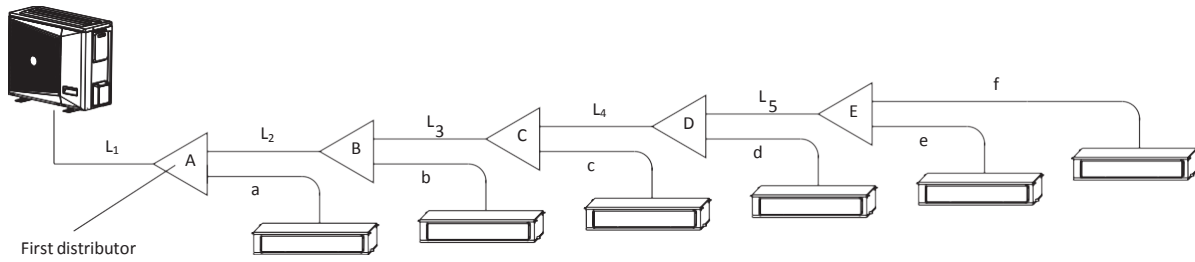

(2) Connecting mode II

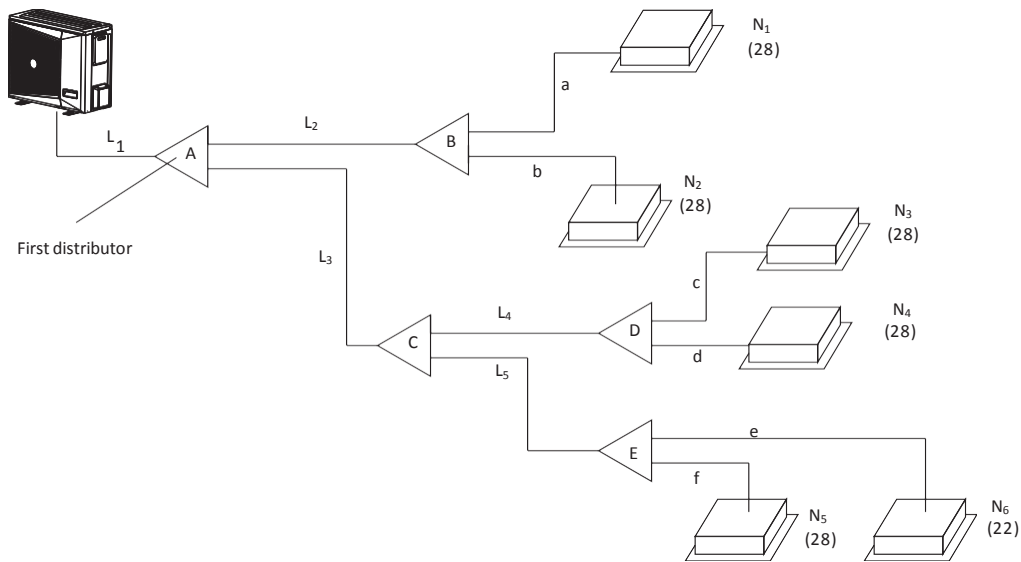

3.3 Determination of main pipe (L1) diameter

Capacity of Outdoor Unit (kW)	Pipe				First distributor
	Dimension of Main Pipe (mm)				
	$L_1 < 30m$		$L_1 \geq 30m$		
	Liquid pipe	Gas pipe	Liquid pipe	Gas pipe	
8	Φ9.52	Φ15.88	Φ9.52	Φ15.88	VAPC060-01701
10	Φ9.52	Φ15.88	Φ9.52	Φ19.05	VAPC060-01701
12.5/14/16	Φ9.52	Φ19.05	Φ9.52	Φ19.05	VAPC060-01701

## 3.4 Determination of main pipe (L2-L5) diameter

Capacity of Downstream Indoor Unit (kW)	Length of Downstream Equivalent Pipe		
	Dimension of main pipe of indoor unit		Applicable to distributor
	Liquid pipe	Gas pipe	
$W < 6.5$	$\Phi 9.52$	$\Phi 12.7$	VAPC060-01701
$6.5 \leq W < 18$	$\Phi 9.52$	$\Phi 15.88$	VAPC060-01701
$18 \leq W < 22$	$\Phi 9.52$	$\Phi 19.05$	VAPC060-01701

## 3.5 Allowable length and level difference of refrigerant pipe

(1) Connecting mode I

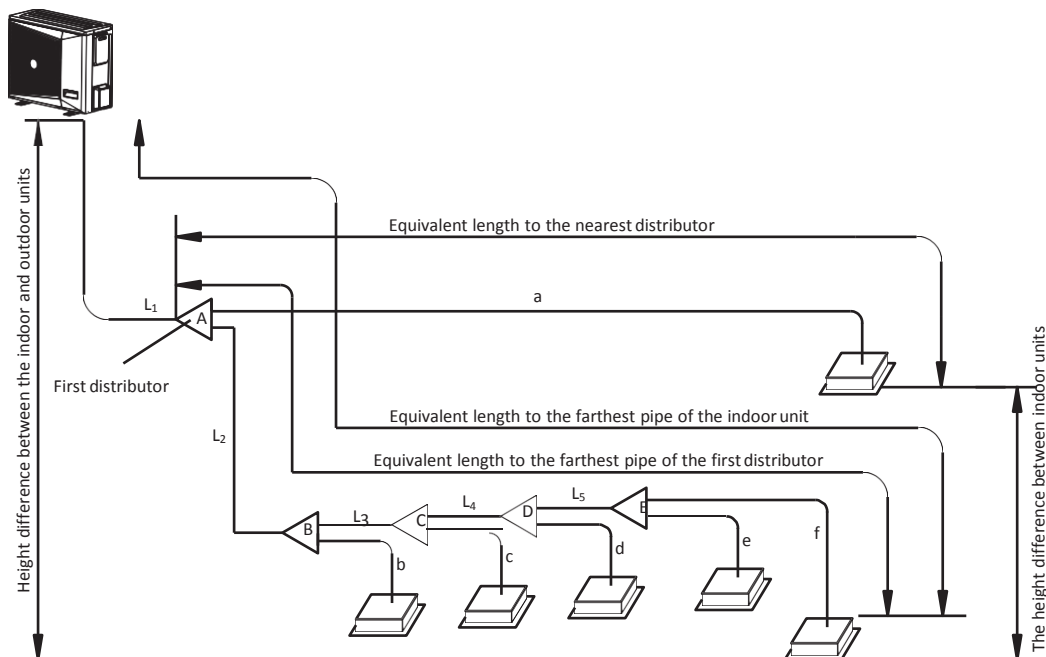



(2) Connecting mode II

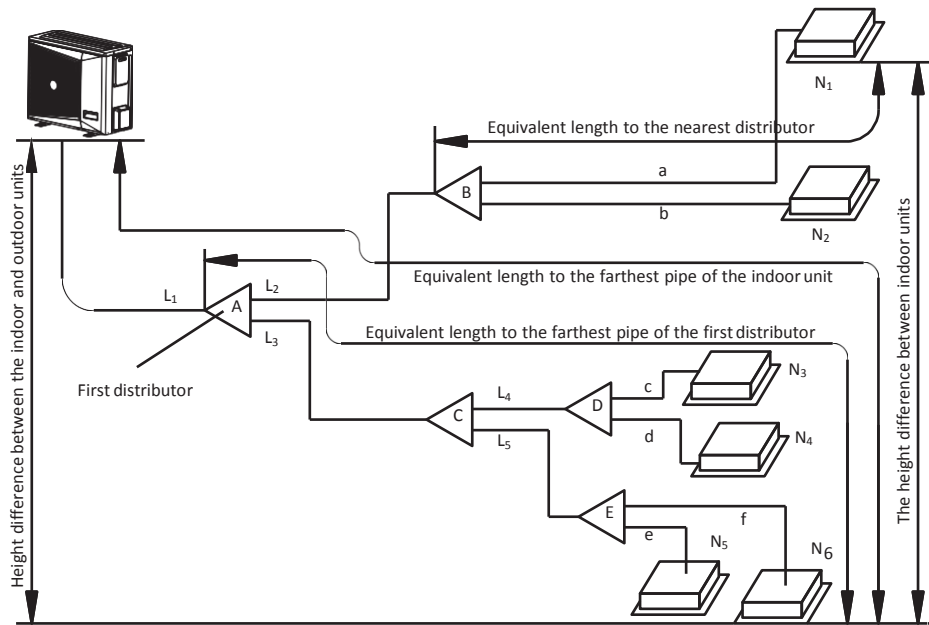

<b>Total Pipe Length</b>		≤100m	$L_1+L_2+L_3+L_4+L_5+a+b+c+d+e+f$
<b>Length of the farthest pipe L</b>	<b>Actual length</b>	≤60m	$L_1+L_2+L_3+L_4+L_5+f$ (connecting mode I) or $L_1+L_3+L_5+f$ (connecting mode II)
	<b>Equivalent length</b>	≤70m	
<b>Equivalent length to the farthest pipe of the first distributor</b>		≤20m	$L_2+L_3+L_4+L_5+f$ (connecting mode I) or $L_3+L_5+f$ (connecting mode II)
<b>Equivalent length to the nearest distributor</b>		≤15m	a, b, c, d, e, f
<b>Height difference between indoor and outdoor units</b>	<b>Outdoor upper</b>	≤30m	-
	<b>Outdoor lower</b>	≤20m	-
<b>Height difference between the indoor units</b>		≤8m	-

## 3.6 Installation of distributor

- (1) The distributor shall use U-type or Y-type, instead of T-type.
- (2) The distributor shall be installed horizontally, with the deviation angle of no greater than  $\pm 10^\circ$ .
- (3) The distributor cannot be turned directly, with the straight pipe of no less than 0.8m.

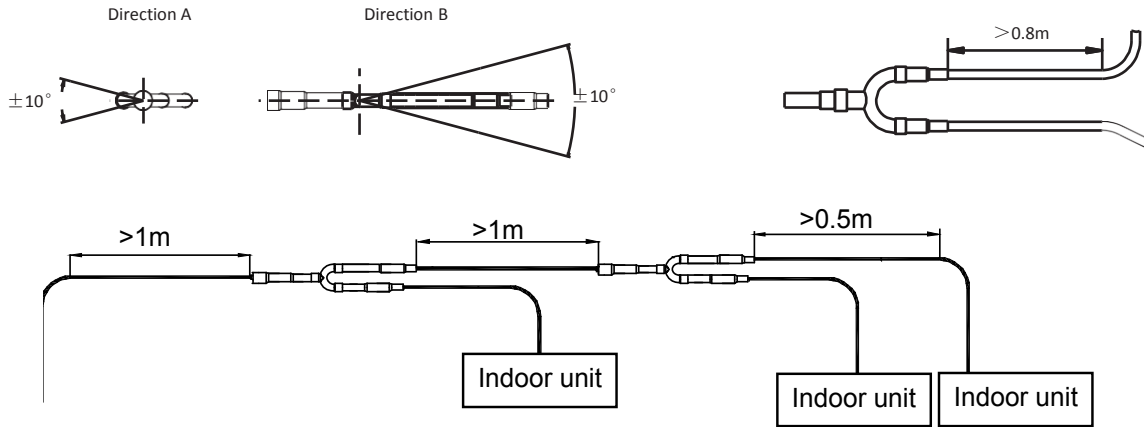

## 3.7 Oil return bend settings

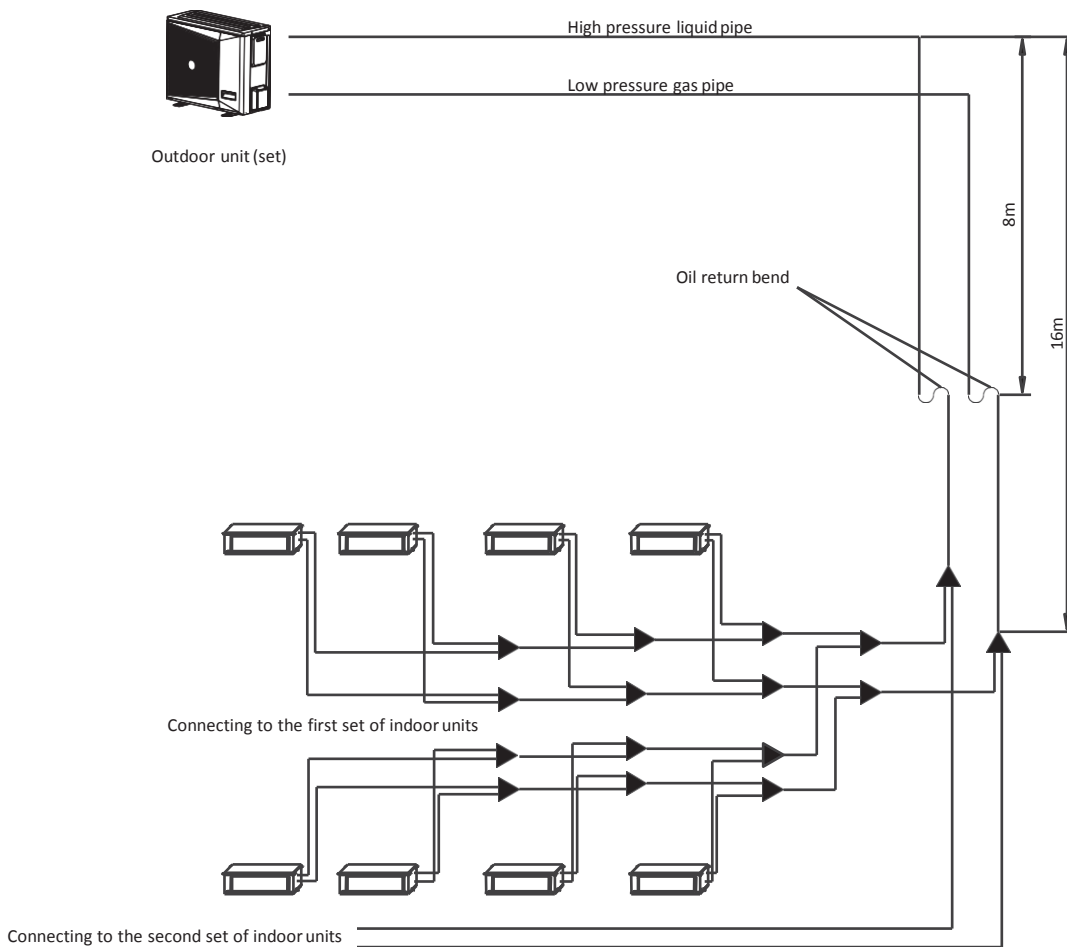

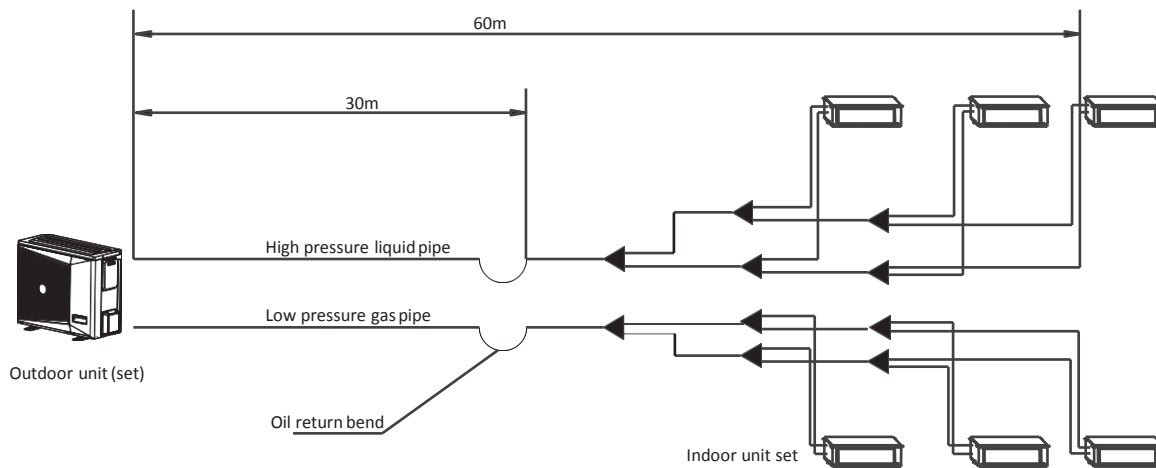

### 3.8 Remove Dirt or Water in the Piping

Make sure there is no any dirt or water before connecting the piping to the outdoor units. Wash the piping with high pressure nitrogen, never use refrigerant of outdoor unit.

### 3.9 Airtight Test

- (1) After the refrigerant pipe is installed and connected to the indoor unit, and before the connecting pipes between the indoor and outdoor units are connected to the valves of the outdoor units, refill the nitrogen with the pressure of  $40\text{kgf/cm}^2$  ( $4.0\text{MPa}$ ) from the gas side and the fluid side simultaneously, mark the pressure value, and then perform 24-hour air tightness test.
- (2) If the pressure drops, recheck the leakage of all interfaces and then maintain the pressure for 24 hours.
- (3) Don't connect with the outdoor unit during maintaining the pressure.

### 3.10 Vacuum

- (1) The vacuum pump has the vacuum degree of less than  $-0.1\text{MPa}$  and the air displacement of more than  $40\text{L/min}$ .
- (2) It is unnecessary to vacuumize the outdoor unit. Don't open the check valves at the gas side and the liquid side of the outdoor unit.
- (3) Make sure the vacuum pump can drop up to  $-0.1\text{MPa}$  within 2 hours; if it fails to drop up to  $-0.1\text{MPa}$  after 3 hours, check moisture or air leak.
- (4) The vacuum pump must have a check valve. Make sure there is no any dirt or water before connecting the piping to the outdoor units. Wash the piping with high pressure nitrogen, never use refrigerant of outdoor unit.

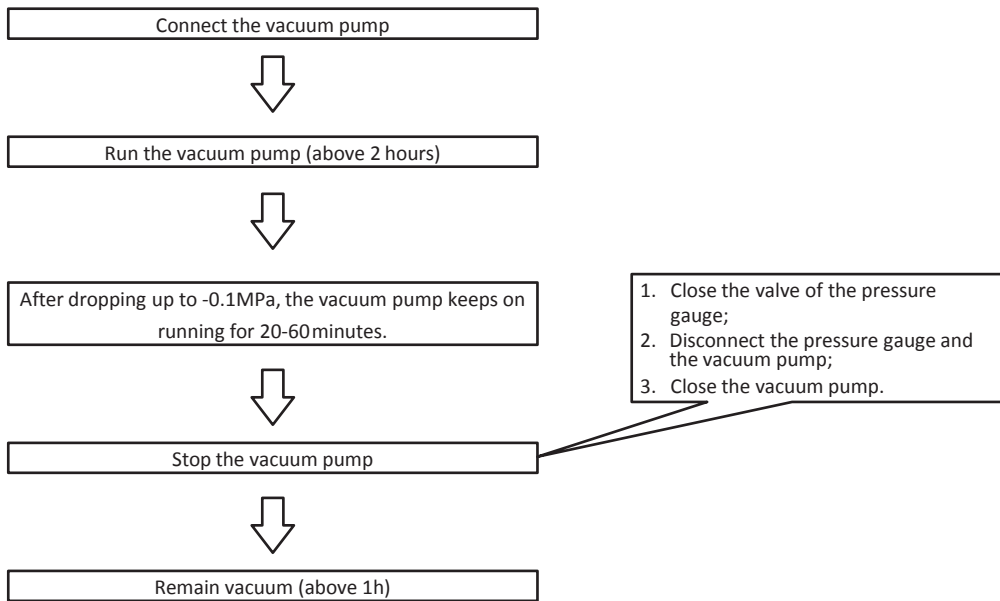

### 3.11 Additional refrigerant charge

The additional refrigerant (R410A) charge is calculated according to the diameter and length of the pipe at the liquid side of the indoor and outdoor units.

Diameters of pipe at the liquid side (mm)	Additional refrigerant charge equal to the length of 1m pipe (unit: kg)
φ6.35	0.023
φ9.52	0.040

Note: The R410A refrigerant must be weighed by an electronic scale and filled in the liquid state.

### 3.12 Leakage detection

Use soap water or leakage detector to check every joint whether leaks or not.

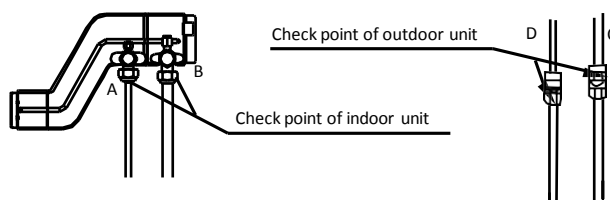

### 3.13 Heat Insulation

Do the heat insulation to the pipes of gas side and liquid side separately. The temperature of the pipes of gas side and liquid side when cooling, for avoiding condensation please do the heat insulation fully.

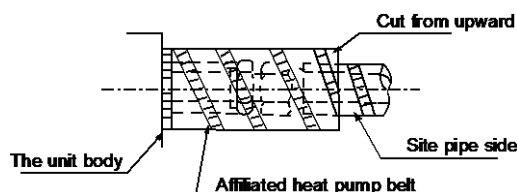

### 3.14 Stop valve instructions

(1) It is closed when leaving the factory, open the valve counterclockwise or close the valve clockwise with a 6mm socket head wrench.

(2) After completing the operation, tighten the valve cover.

(3) R410A special tool shall be used to vacuumize the valve and fill the refrigerant at the service entrance. Fill the refrigerant at the service entrance at the gas side, and vacuumize the valve at the service entrance at the liquid side and the gas side simultaneously.

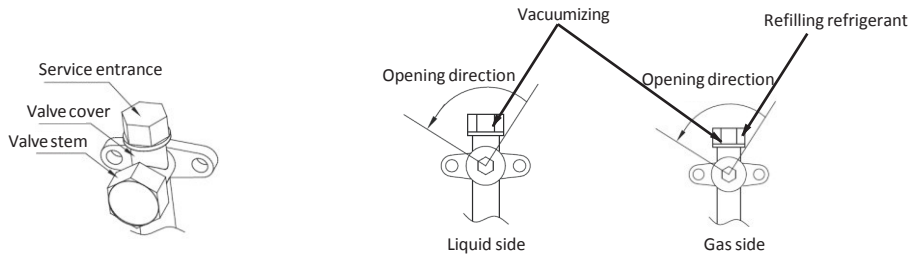

## 4. Electric Wiring Installations

### 4.1 Outdoor unit wiring

Capacity (kW)	Power Supply	Power Line (mm <sup>2</sup> )	Breaker/Fuse (A)	Signal Wire between Indoor and Outdoor Units (mm)
8/10	220-240V 50Hz/60Hz	3 × 4.0	40/30	three-core shielded cable 3 × 1.0
12.5/14/16	220-240V 50Hz/60Hz	3 × 6.0	63/45	

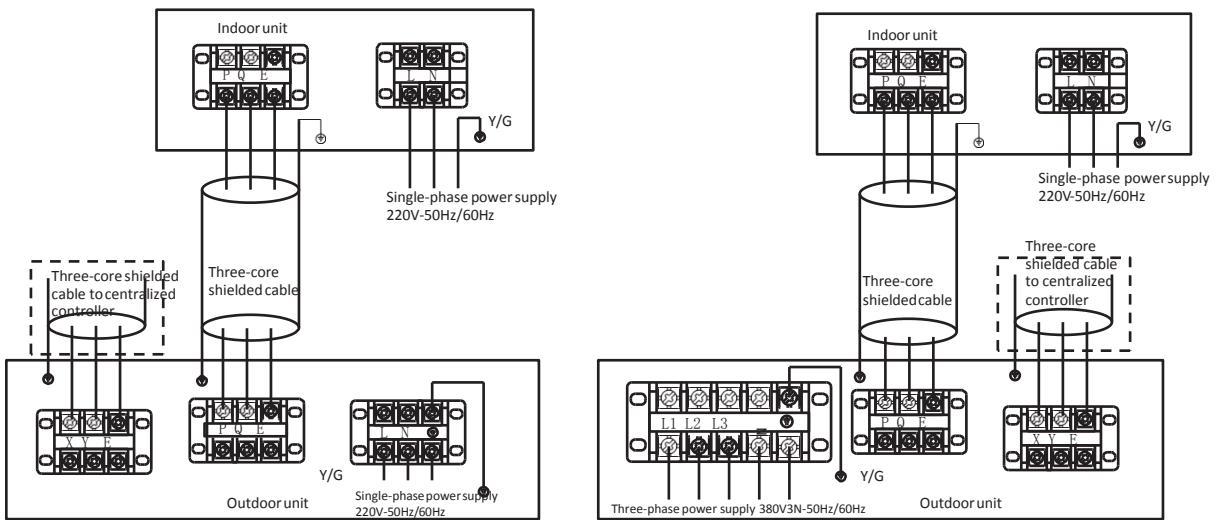
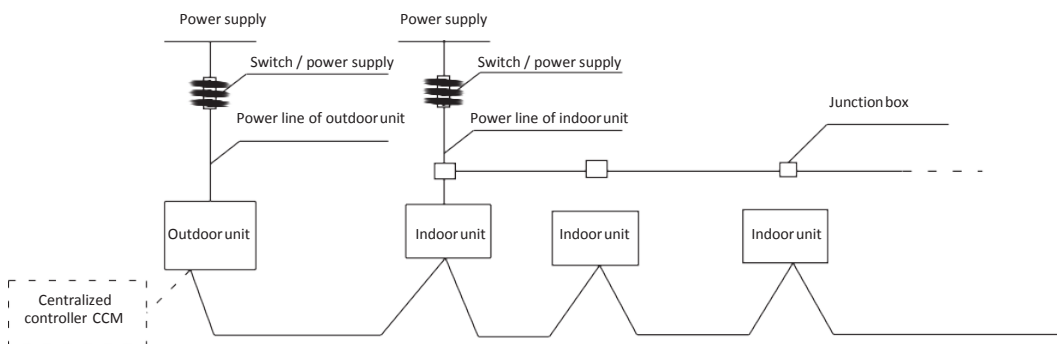

### 4.2 Indoor unit power supply wiring

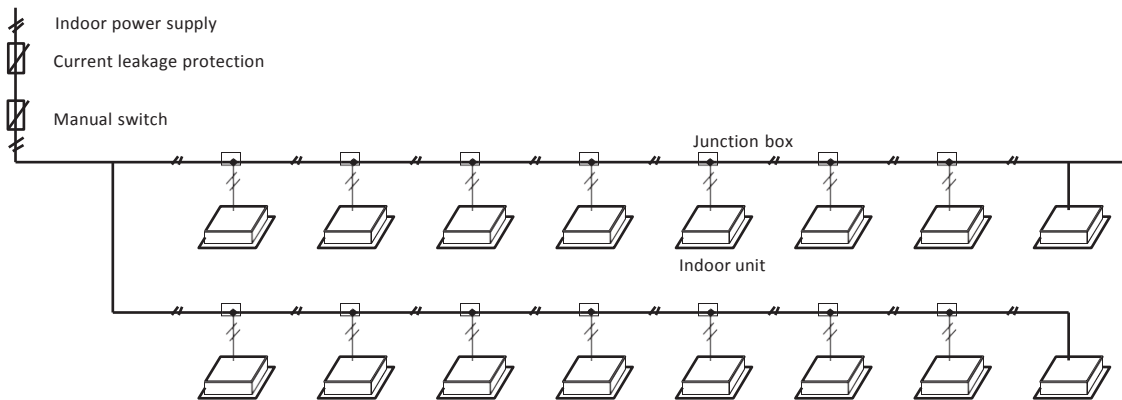

When the power wire is parallel to the signal wire, please put the electrical wires into their own wire pipes, with proper wire spacing (10A or below: 300mm, 50A or below: 500mm).

Capacity (kW)		2.2-16
Indoor unit power	Phase	Single phase
	Frequency and Voltage	220-240V~ 50Hz
	Power wiring(mm <sup>2</sup> )	3×1.0
Circuit Breaker (A)		16
Indoor unit/Outdoor unit Signal wire (Weak electric signal) (mm <sup>2</sup> )		3-core shielded wire 3 X0.75

### 4.3 Indoor unit signal wiring

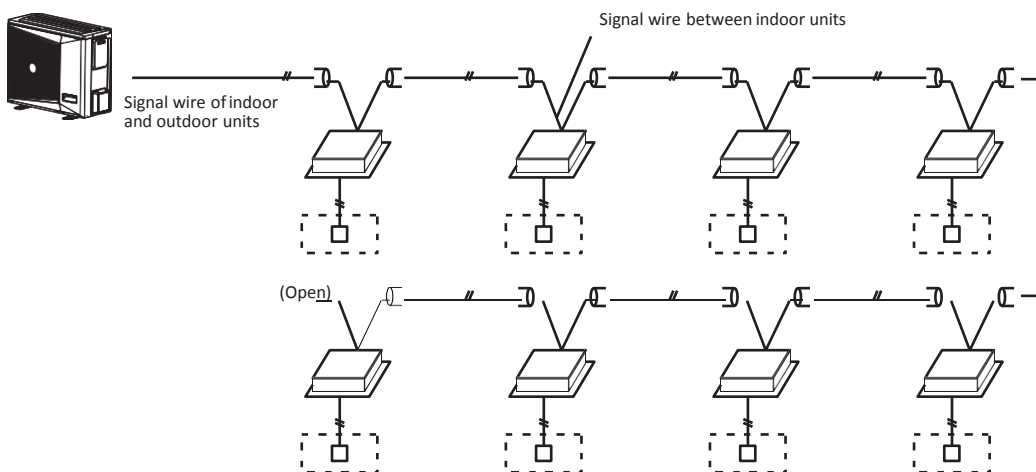

- (1) Please select power source for indoor unit and outdoor unit respectively.
- (2) The power supply has specified branch circuit with leakage protector and manual switch. Indoor unit connect with power supply which is 220-240V~50Hz. Outdoor unit connect with power supply which is 220-240V~50Hz (Please set all the indoor unit power supply of one system into the same circuit. It should turn on or shut down the unit at the same time, otherwise, the service life would affect seriously, even the unit may not turn on.)
- (3) Please put the connective wire system between indoor unit and outdoor unit with the refrigerant system together.
- (4) Use 3-core shielded cable as indoor and outdoor control wire.
- (5) Power wiring should be engaged by professional electrician.

## 5. Test Running

### 5.1 Inspection and confirmation before debugging

- (1) Check and make sure the refrigerating pipeline and communication line connecting with the indoor and outdoor units are connected with the same refrigerating system. Otherwise, some running faults occur.
- (2) The power supply voltage is within the rated voltage of  $\pm 10\%$ .
- (3) Check and make sure the power supply line and the control line are correctly connected.
- (4) Before power-on, make sure there is no short circuit.
- (5) Check if all units have passed 24-hour nitrogen pressure-maintaining (40kgf/cm<sup>2</sup>) test.
- (6) Make sure the debugged system is fully vacuumized, dried and filled with the refrigerant as specified.

### 5.2 Preparation before debugging

- (1) Prepare the required refrigerant. Calculate the refilling volume of refrigerant for each set of units according to the length of on-site liquid pipe.
- (2) Prepare the system plan, system piping diagram and control wiring diagram. Mark the set address codes on the system plan.
- (3) Turn on the power supply switch of the outdoor unit in advance, and make sure it is power-on for more than 12 hours, so that the heater heats the compressor oil.
- (4) Fully open air pipe check valve, liquid pipe check valve and oil balance valve of the outdoor unit. If they are fully opened, the machine may be damaged.
- (5) Check if the power supply phase sequence of the outdoor unit is correct. Check if all dialing switches of the indoor and outdoor units are set according to the technical requirements of the product.
- (6) When the multiple indoor units are arranged, in order to distinguish the connecting systems of indoor and outdoor units, all systems shall be named respectively and recorded on the nameplate on the electronic control box cover of the outdoor unit.

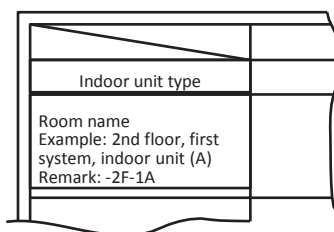



## 6. Precautions on Refrigerant Leakage

### 6.1 Inspection and confirmation before debugging

- (1) The refrigerant of the air conditioner is harmless and nonflammable.
- (2) The room for the air conditioner shall have an appropriate space. In case of refrigerant leak, it cannot go beyond the critical concentration. In addition, necessary measures can be taken.
- (3) The critical gas concentration harmless to the human body is 0.3 kg/m<sup>3</sup>.
- (4) Confirm the critical concentration according to the following steps and take corresponding measures.

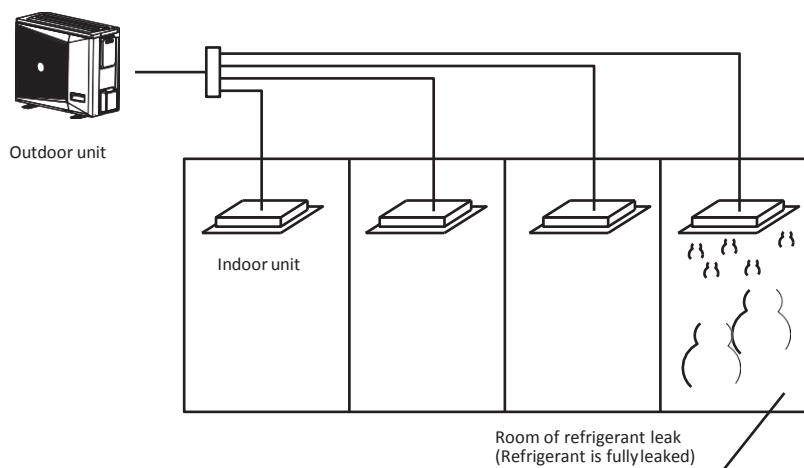
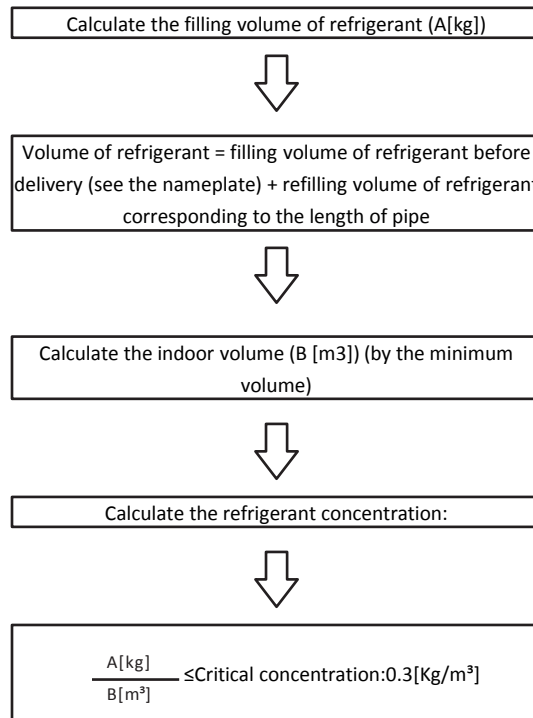

(5) Measures against exceeding the critical concentration.

a). To reduce the refrigerant concentration below the critical concentration, install a mechanical ventilation device (for frequent ventilation).

b). If frequent ventilation cannot be performed, please install a leak warning device interlinked with the mechanical ventilation device.

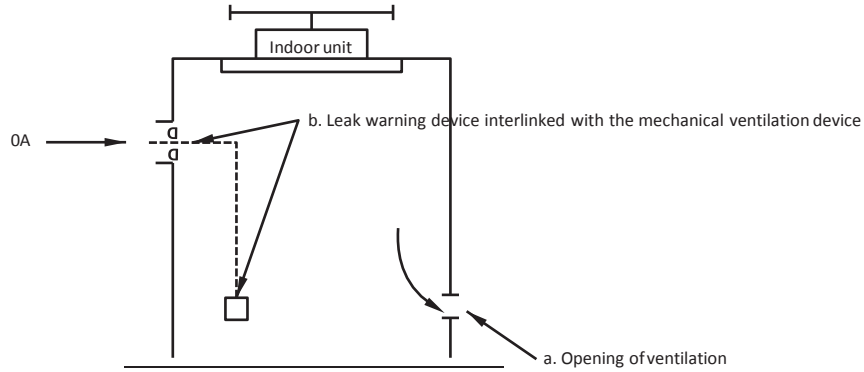

(The leak warning device shall be installed in the gathering place of refrigerant.)

# Part 4

# Troubleshooting

1	Exploded Views .....	82
2	PCB Ports Instructions .....	84
3	Dialing Setting .....	86
4	Error Code Table .....	88
5	Troubleshooting.....	89

## 1. Exploded Views

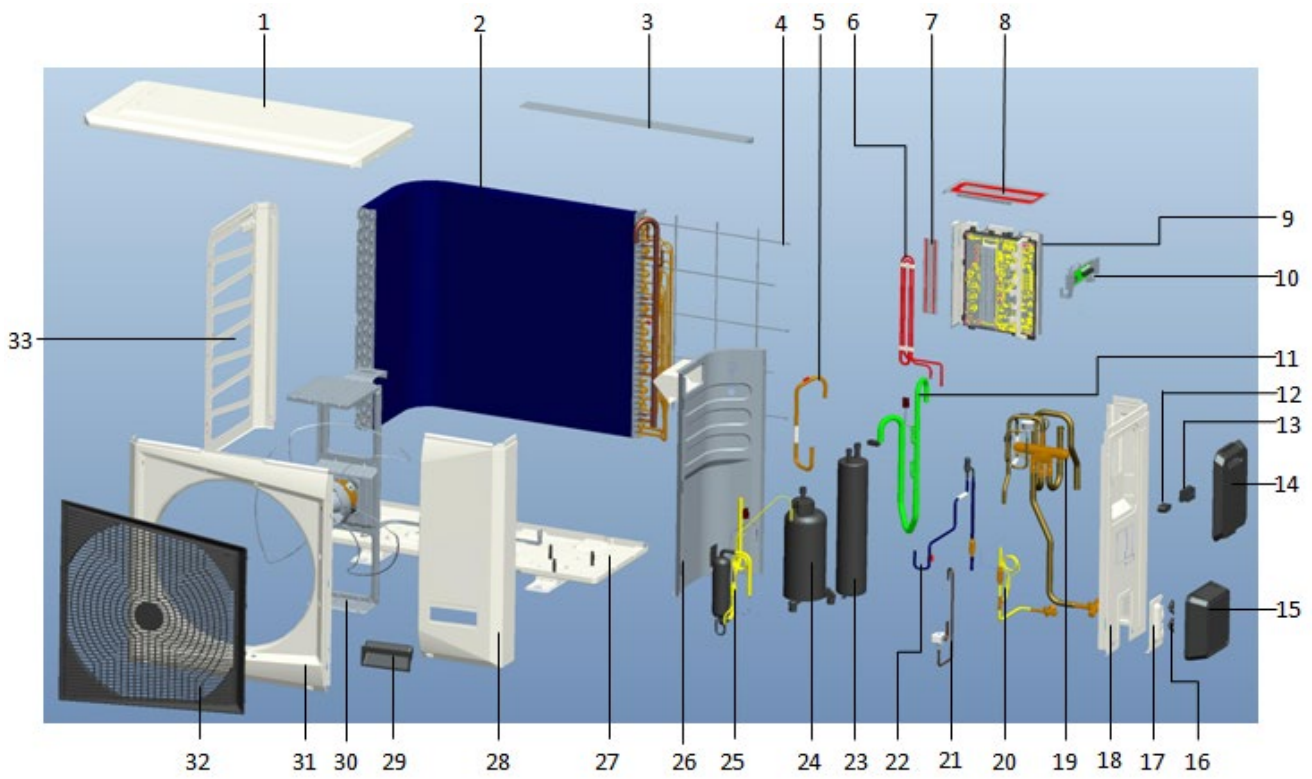
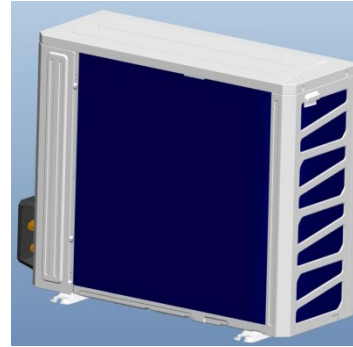
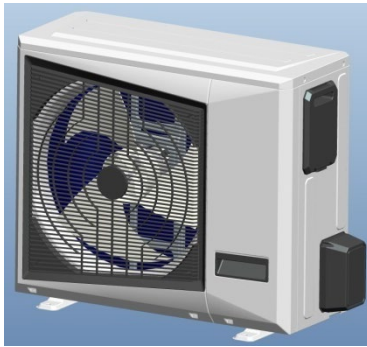

VNMF Mini Series Service Manual

No.	Part name	Quantity	No.	Part name	Quantity
1	Top cover cotton component	1	16	Seat plate sealing cover	2
2	Condenser part	1	17	Seat plate	1
2.1	Condenser assembly	1	18	Right side panel	1
2.2	Condenser gas collection component	1	19	Four-way valve component	1
2.3	Condenser splitter assembly	1	20	High pressure valve component	1
2.4	Condenser supercooled outlet	1	21	Solenoid valve component	1
3	Top beam	1	22	Electronic expansion valve component	1
4	Wire back mesh	1	23	Gas-liquid separator	1
5	Exhaust pipe assembly	1	24	Inverter compressor	1
6	Refrigerant heat pipe parts	1	25	Oil separator component	1
7	Radiator cover	1	26	Middle partition part	1
8	Electric control box cover	1	27	Chassis welding assembly	1
9	Electronic control part	1	28	Maintenance board sticking component	1
9.1	Electric control mounting plate riveting assembly	1	29	Little hand	1
9.2	Main control board mounting assembly	1	30	Motor component	1
9.3	Filter board mounting assembly	1	30.1	Motor bracket assembly	1
9.4	Overpass groove	1	30.2	DC motor mounting plate assembly	1
10	Communication board installation component	1	30.3	Single axis outdoor DC motor	1
11	Return air pipe component	1	30.4	Axial flow blade	1
12	Crimping button	1	31	Front panel	1
13	Terminal block	1	32	Air outlet net cover	1
14	Large hand sticking components	1	33	Left side board	1
15	Stop valve cover	1			

## 2. PCB Ports Instructions

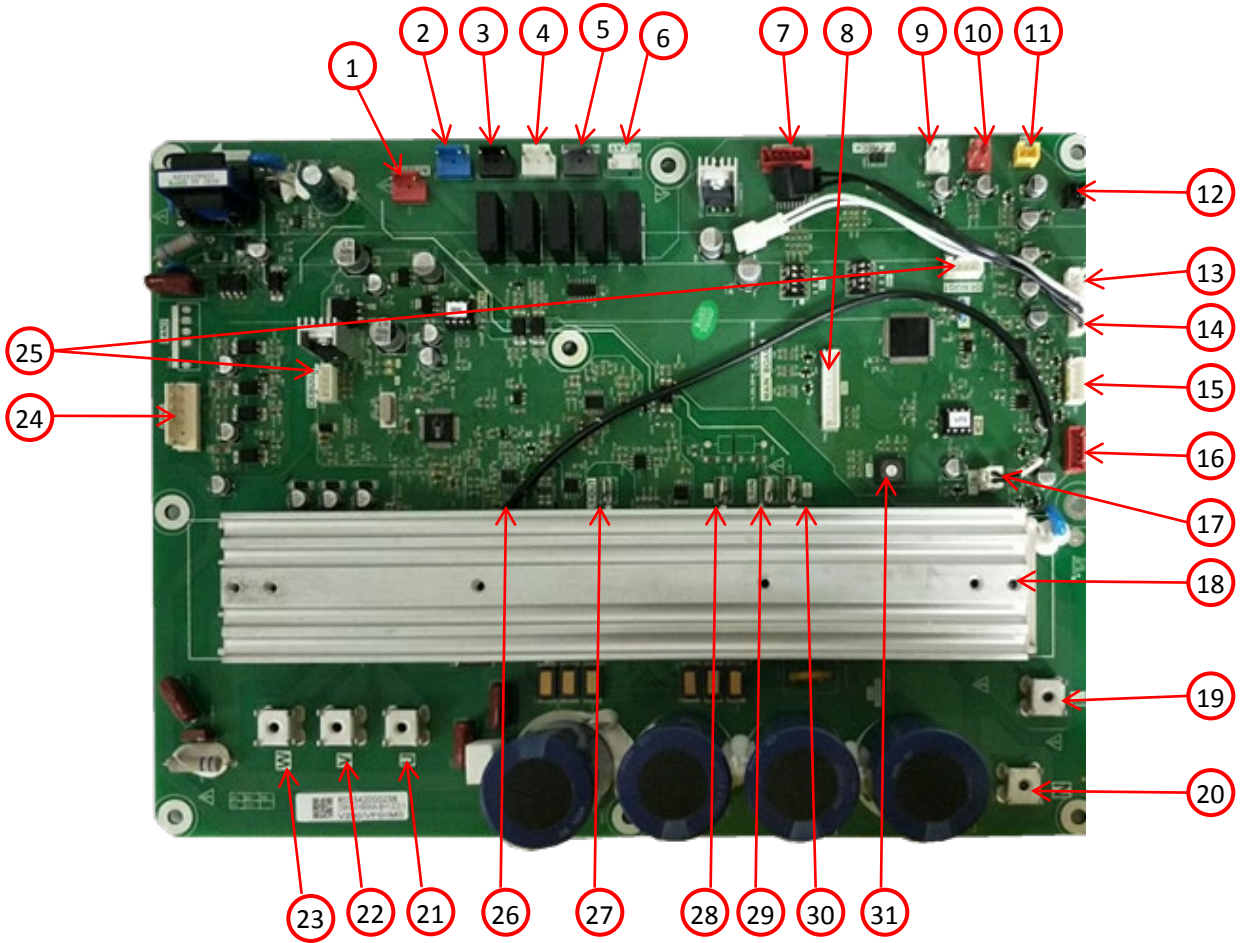

### PCB ports instruction:

No.	Content	Remark
1	AC220V	220V AC output interface
2	4-WAY	4-way valve interface
3	SV2	Injection cooling valve interface
4	SV3	Low temp. heating bypass valve interface
5	HEAT	Electric heating interface
6	RLY	Relay
7	EXV	Electronic expansion valve interface
8	CN26	Terminal for inspection signal wire
9	LP	Low pressure switch signal
10	HP	High pressure switch signal
11	T7	Refrigerant heat pipe temperature
12	T3B	Condenser middle temperature
13	T5	Compressor exhaust temperature
14	T3&T4	Condenser outlet/ Ambient temperature
15	COMM	Terminal for communication signal wire
16	CN24	Filter board control interface
17	T6	Radiator temperature
18	Refrigerant radiator	----
19	L	----
20	N	----
21	U	Inverter compressor
22	V	Inverter compressor
23	W	Inverter compressor
24	FAN1	Fan interface
25	DEBUG 1/2	----

No.	Content	Remark
26	TEM-M	Radiator temperature sensor
27	L1-OUT	PFC inductor_1 output
28	L2-OUT	PFC inductor_2 output
29	L1-IN	PFC inductor_1 input
30	L2-IN	PFC inductor_2 input
31	SW4	Outdoor unit capacity

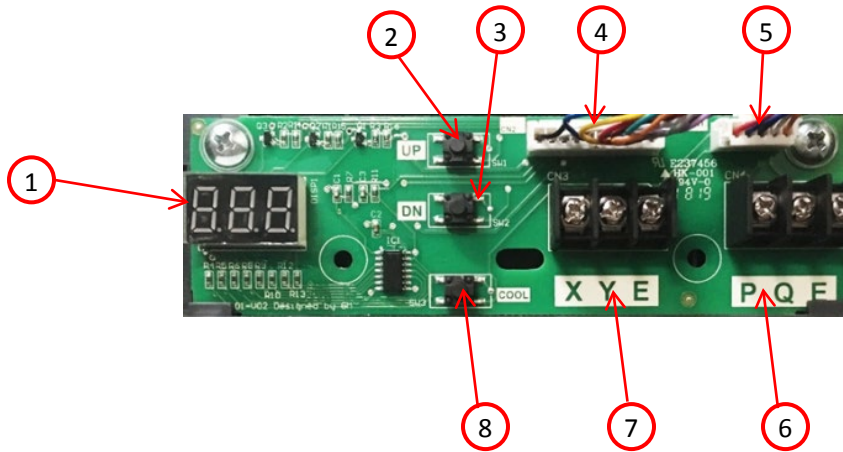





**PCB ports instruction:**





No.	Content	Remark
1	Outdoor digital tube	Display running parameter or error code
2	UP	Inspection-up button
3	DN	Inspection-down button
4	CN2	Terminal for inspection signal wire
5	CN1	Terminal for communication signal wire
6	P, Q, E	Indoor unit communication interface
7	X, Y, E	Centralized control interface
8	COOL	Forced cooling (Commissioning)

## 3. Dialing Setting







### 3.1 Silent mode choosing by SW5 dialing definition

Dialing	Silent Mode
ON  1 2	Standard Mode (Factory default)
ON  1 2	Strong Silent Mode
ON  1 2	Night Silent Mode
ON  1 2	High Static Pressure Mode

### 3.2 Night time choosing by SW5 dialing definition

Dialing	Night Time
ON  3 4	6/10
ON  3 4	6/12
ON  3 4	8/10
ON  3 4	8/12

### 3.3 Priority mode choosing by SW5 dialing definition

Dialing	Priority Mode
ON  1 2 3	Automatic selection mode preferred (factory default)
ON  1 2 3	Heating mode priority
ON  1 2 3	Cooling mode priority
ON  1 2 3	Only respond to heating mode
ON  1 2 3	Only respond to cooling mode
ON  1 2 3	VIP+Automatic priority
ON  1 2 3	Fist open mode priority



3.4 Define outdoor unit capacity by SW4 dialing



The number you dial means the capacity of outdoor unit selected

Dialing	Capacity
1	8kW
2	10kW
3	/
4	12.5kW
5	14kW
6	16kW

3.5 Inspection Instructions of Outdoor Unit for VNMF\* Series

No.		Display contents	Remarks
0	0	Current frequency / number of indoor units	Display number of units turned on when standby
1	1-	Capacity of outdoor unit	80, 100, 112, 120, 140, 160, 180
2	2-	Operation mode	0:off/fan; 2:cooling; 3:heating; 4:forced cooling
3	3-	Total capacity need of indoor unit	
4	4-	Actual capacity needs revised by outdoor unit	
5	5-	Actual running capacity of outdoor unit	
6	6-	Fan status(fan speed)	0-8
7	7-	T2/T2B average temperature	T2B average when cooling, T2 average when heating
8	8-	T3 pipe temperature	
9	9-	T3B condenser temperature	
10	10-	T4 outdoor air temperature	
11	11-	T5 exhaust temperature	
12	12-	T6 refrigerant cooling panel temperature	
13	13-	T7 refrigerant cooling inlet pipe temperature	
14	14-	Electronic expansion valve opening degree	Actual value=display value*8
15	15-	Primary current	
16	16-	Secondary current	
17	17-	Primary voltage	
18	18-	Secondary voltage(DC bus)	Actual value=display value*4
19	19-	Number of indoor units	
20	20-	Number of operating indoor units	
21	21-	Priority mode	0:Auto ; 1:heating priority; 2:coolingpriority; 3:only heating 4:only cooling 5:VIP+auto priority 6: First priority
26	26-	Frequency limit display	0: no frequency limit; 1: T3B limit frequency; 2: T4 limit frequency 4: T5 frequency limit; 8: voltage limit frequency; 16: current limit frequency 32: T6 limit frequency 64: silent limit frequency(will displaytotal if there are multiple frequency limits)
27	27-	Last failure or protection code	No protection or fault display---
28	28-	Program version	
29	29-	EEPROM version	

The display content is defined as follows:

Normal display: display the number of indoor units in standby mode, or display the operating frequency of the compressor after the capacity is required;

Operation mode: off or fan: 0, cooling: 2, heating: 3, forced cooling: 4;

The number of indoor units (indoor units that can normally communicate with outdoor units).

## 4. Error Code Table

Fault Code	Fault Contents	Remark
E1	Outdoor unit phase-sequence fault	
E2	Communication fault between the indoor unit and the outdoor unit	20-minute break at first or 2-minute break later
E4	T4 outdoor air temperature sensor fault	
E6	T3 Condenser pipe temperature sensor fault (outlet)	
E8	T5 Exhaust temperature sensor fault	
E9	AC over-voltage / under-voltage protection	
E10	EEPROM fault	
EA	T3B condenser temperature sensor fault (middle)	
Eb	T6 refrigerant cooling panel temperature sensor fault or temperature protection	
EC	T7 refrigerant cooling pipe inlet temperature sensor fault	
E.E	Model error(there is no dialing model in the EEPROM)	
H0	Communication fault of master board and driver chip	
H4	Display P6(IPM module protection) for 3 times within 30 minutes	
H5	Display P2 (system pressure is too low) protection for 3 times within 30 minutes	20-minute break at first or 2-minute break later
H6	Display P4 (T5 Exhaust temperature is too high ) protection for 3 times within 100minutes	Only restore when power on again
H7	The decrease in number of indoor unit	Indoor units are lost for more than 3 minutes. It can't be restored until number of indoor units are restored.
H9	Display P9 (AC fan fault ) protection for 2 times within 10 minutes	Only restore when power on again
H10	Display P3(inverter overcurrent protection) protection for 3 times within 60minutes	Only restore when power on again
H11	Display P13 protection for 2 times within 10 minutes	Only restore when power on again
P1	High pressure protection	
P2	Low pressure protection	Display H5 after P2 protection for 3 times within 30 minutes
P3	Inverter overcurrent protection	
P4	Exhaust overheating protection	Display H6 for 3 times within 100 minutes
P5	T3 or T3B condenser pipe overheating protection	
P6	IPM protection	Display H4 after P6 protection for 3 times within 30 minutes
P9	DC fan fault	Display H9 after P9 protection for 2 times within 10 minutes
P10	Anti-typhoon protection	
P11	T2 high temperature protection when heating	
P12	T3 overheating protection	
P13	Current detection error protection	Effective for 12.5, 14,16, 18kW; no such fault for 8 and 10kw
L0	DC compressor module fault	
L1	DC cable bus low voltage protection	
L2	DC cable bus high voltage protection	
L4	MCE fault / sync / closed loop	
L5	Zero speed protection	
L7	Compressor phase loss protection	
L8	Protection when the speed change at the previous moment and the latter moment is greater than or equal to 15HZ	
L9	Protection when the difference of set speed and actual operation speed is greater than or equal to 15HZ	
Pb	T6 refrigerant cooling panel temperature is too high	

## 5. Troubleshooting

### 5.1 Warning

#### Warning



- All electrical work must be carried out by competent and suitably qualified, certified and accredited professionals and in accordance with all applicable legislation (all national, local and other laws, standards, codes, rules, regulations and other legislation that apply in a given situation).
- Power-off the outdoor units before connecting or disconnecting any connections or wiring, otherwise electric shock (which can cause physical injury or death) may occur or damage to components may occur.

## 5.2 E1: Outdoor unit phase-sequence fault

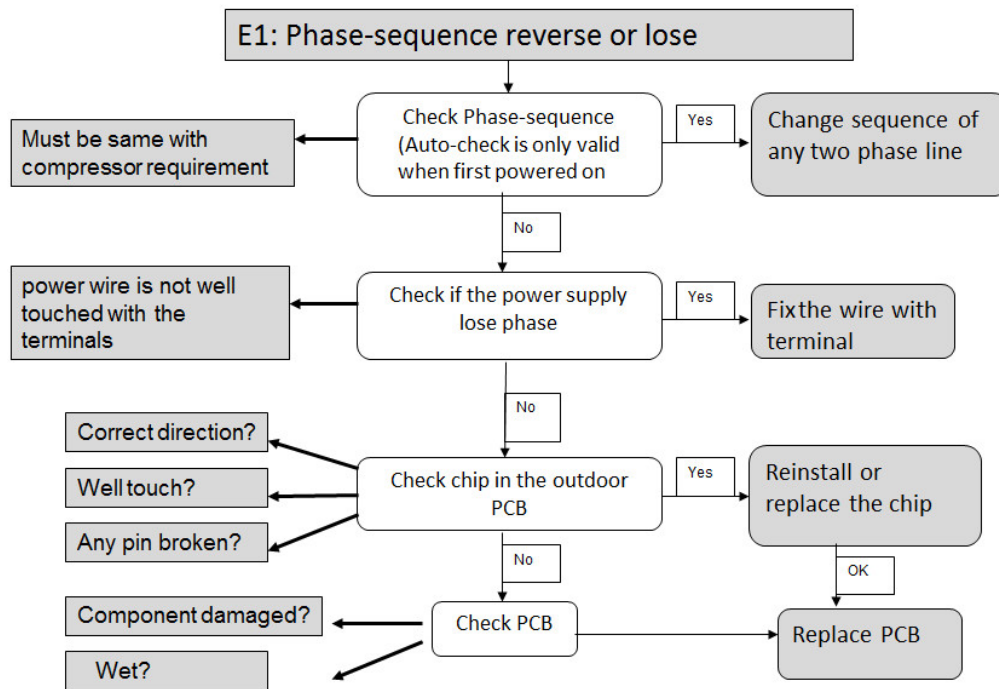

## 5.3 E2: Communication fault between the indoor unit and the outdoor unit

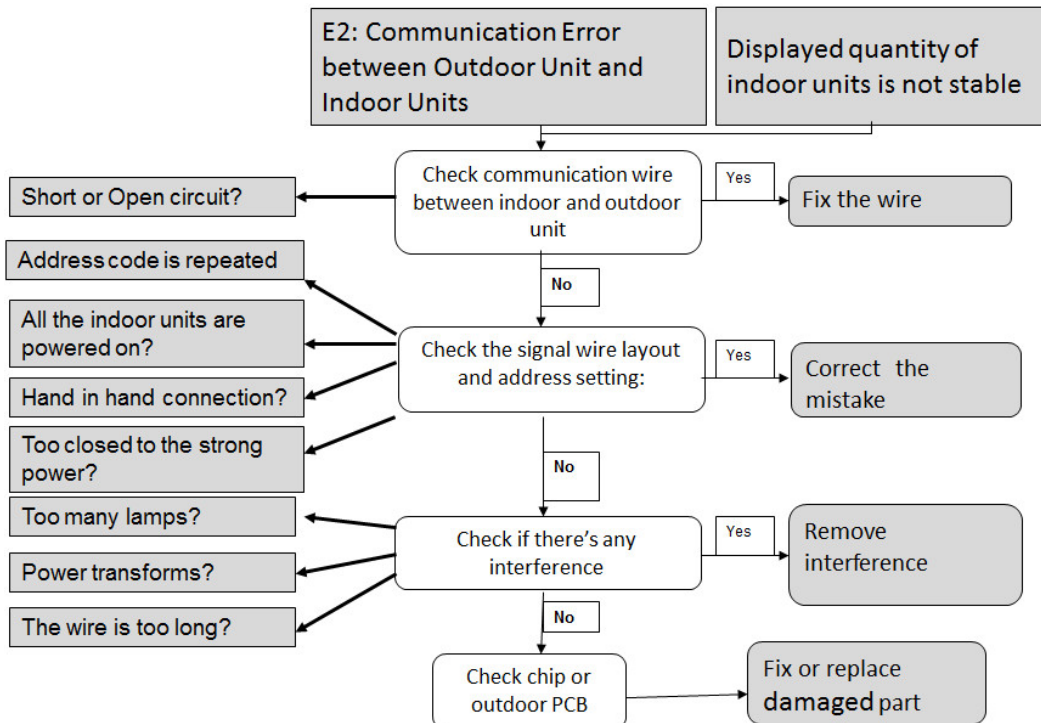

5.4 E4: T4 outdoor air temperature sensor fault

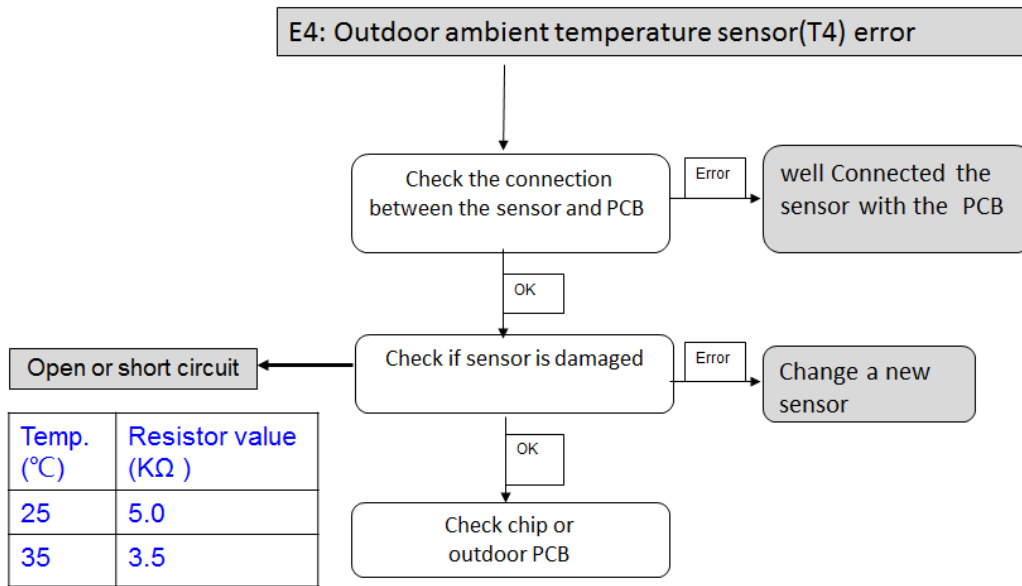

5.5 E6: T3 Condenser pipe temperature sensor fault (outlet)

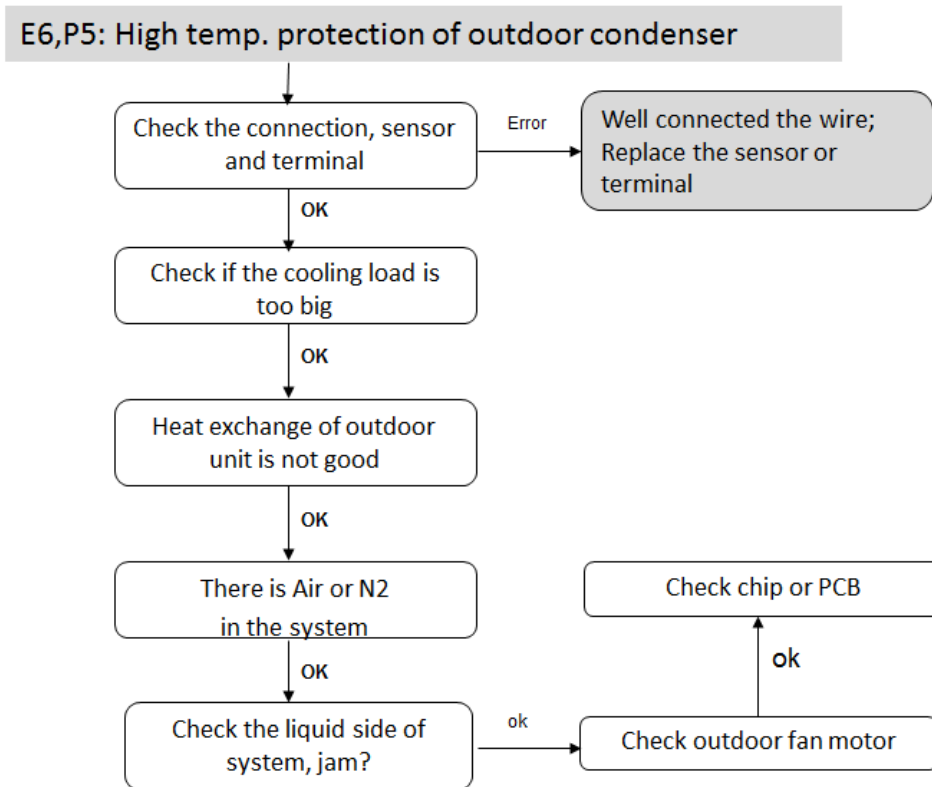

## 5.6 E8: T5 Exhaust temperature sensor fault

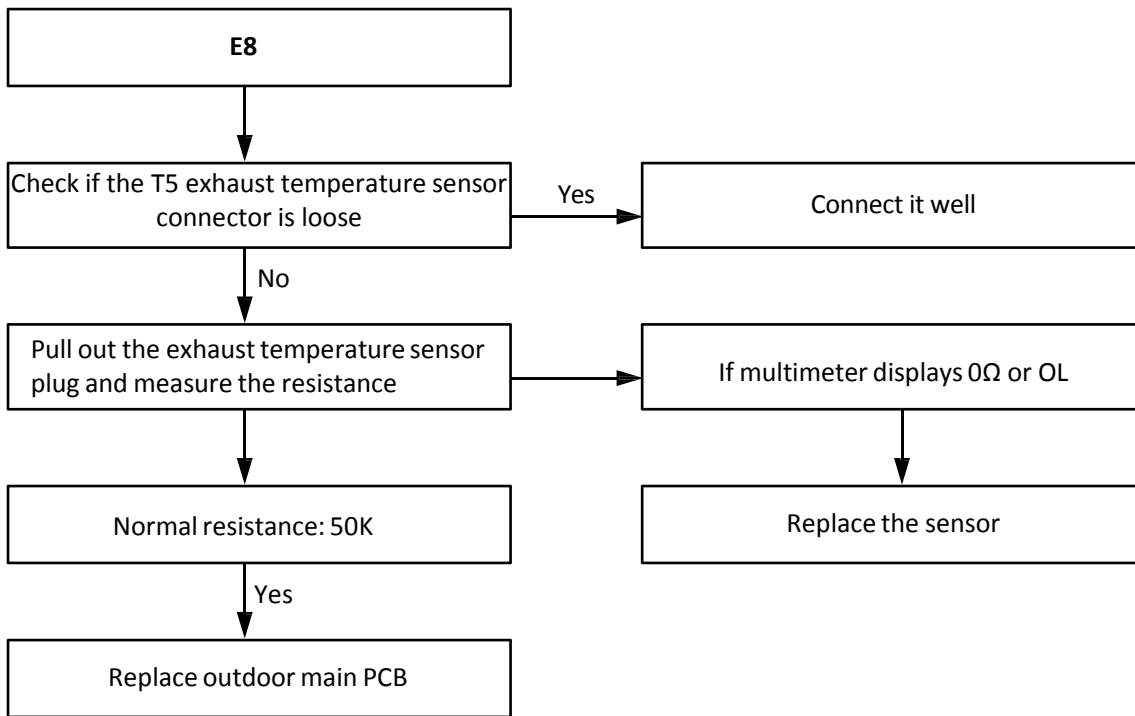

## 5.7 E9: AC over-voltage / under-voltage protection

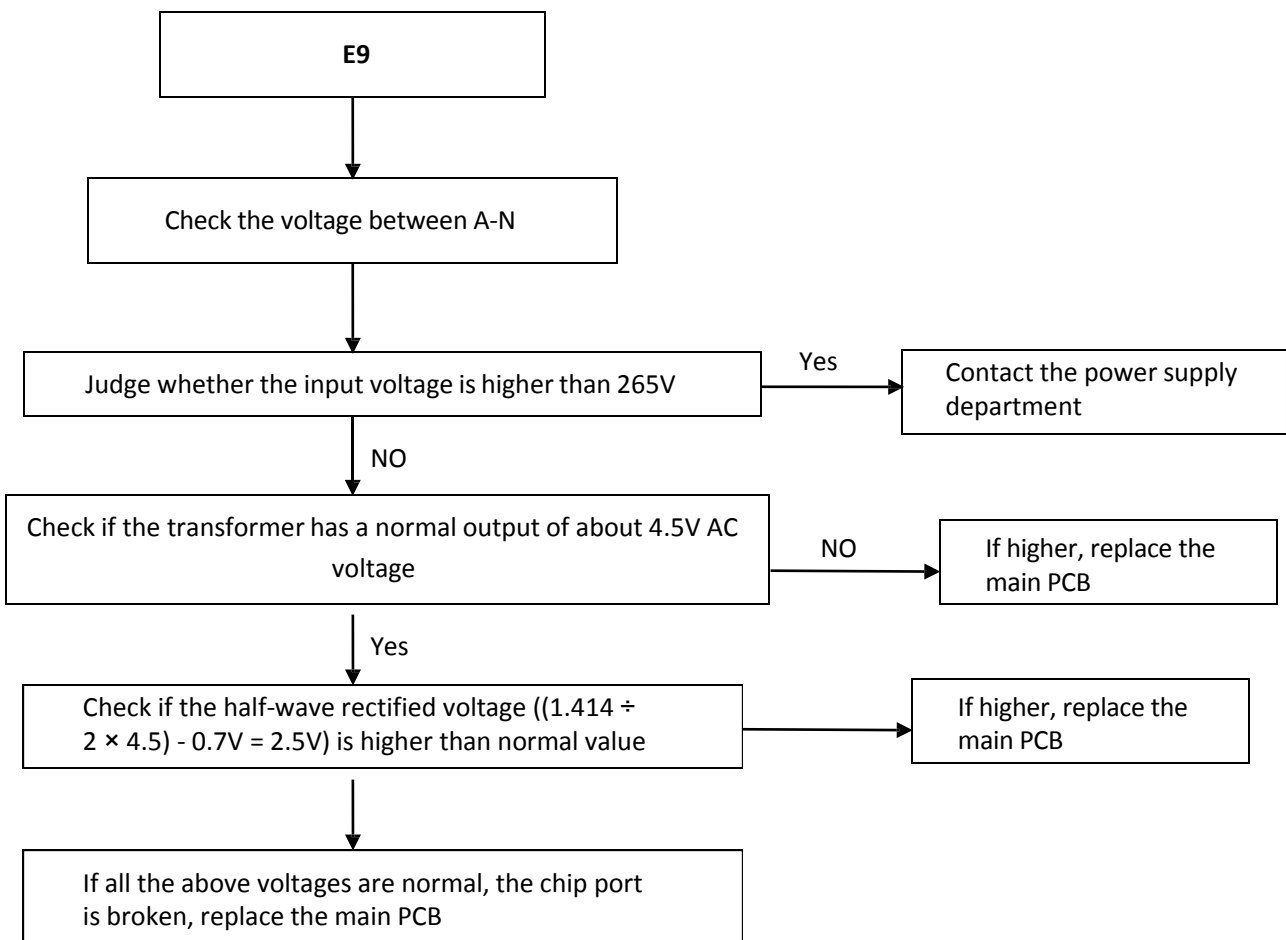

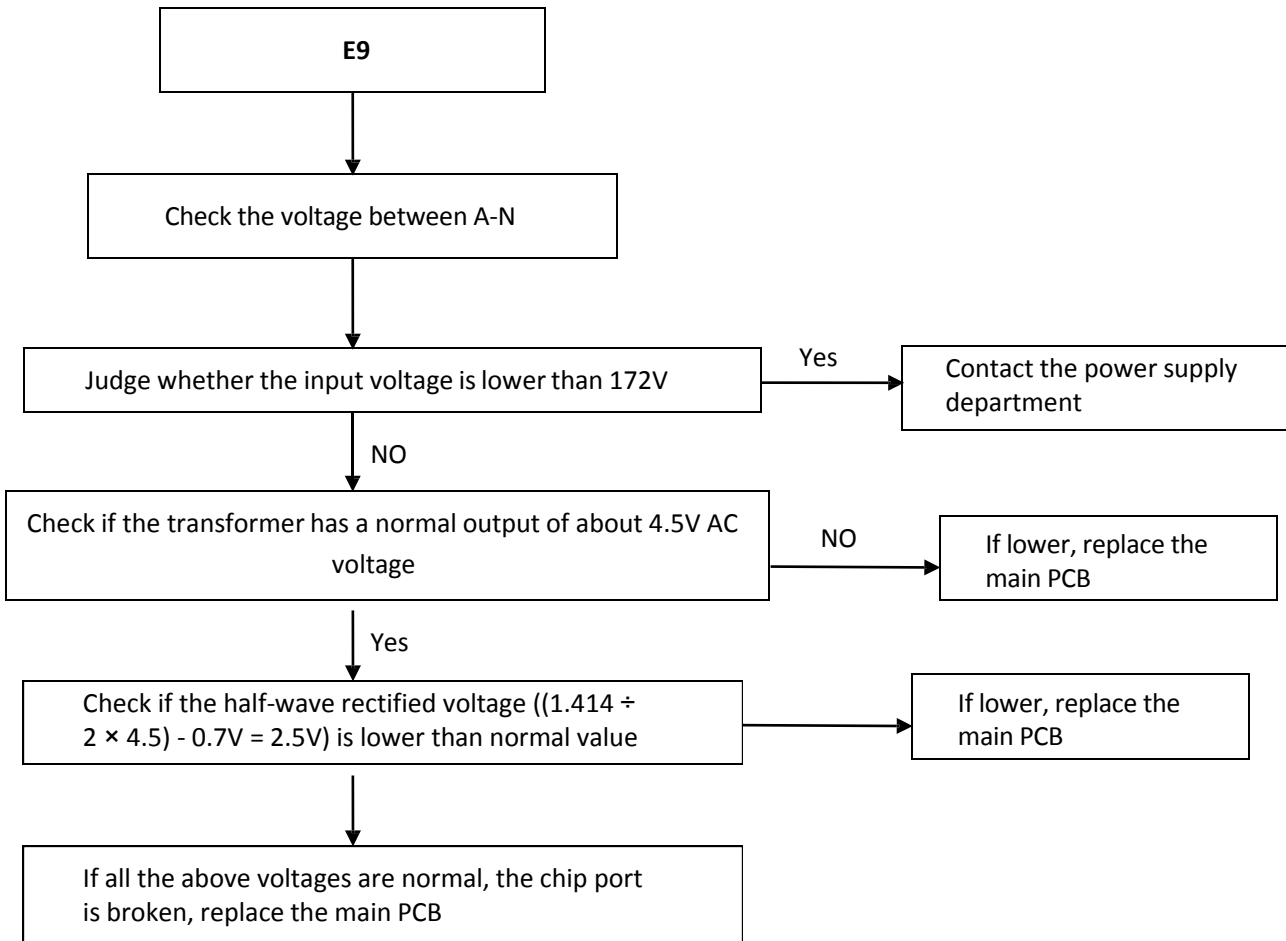

5.8 E10: EEPROM fault

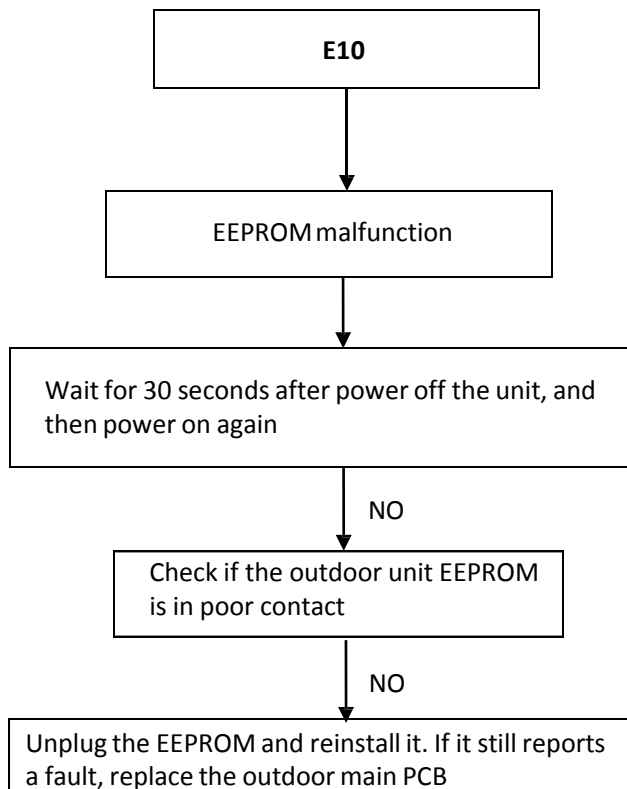

## 5.9 EA: T3B condenser temperature sensor fault (middle)

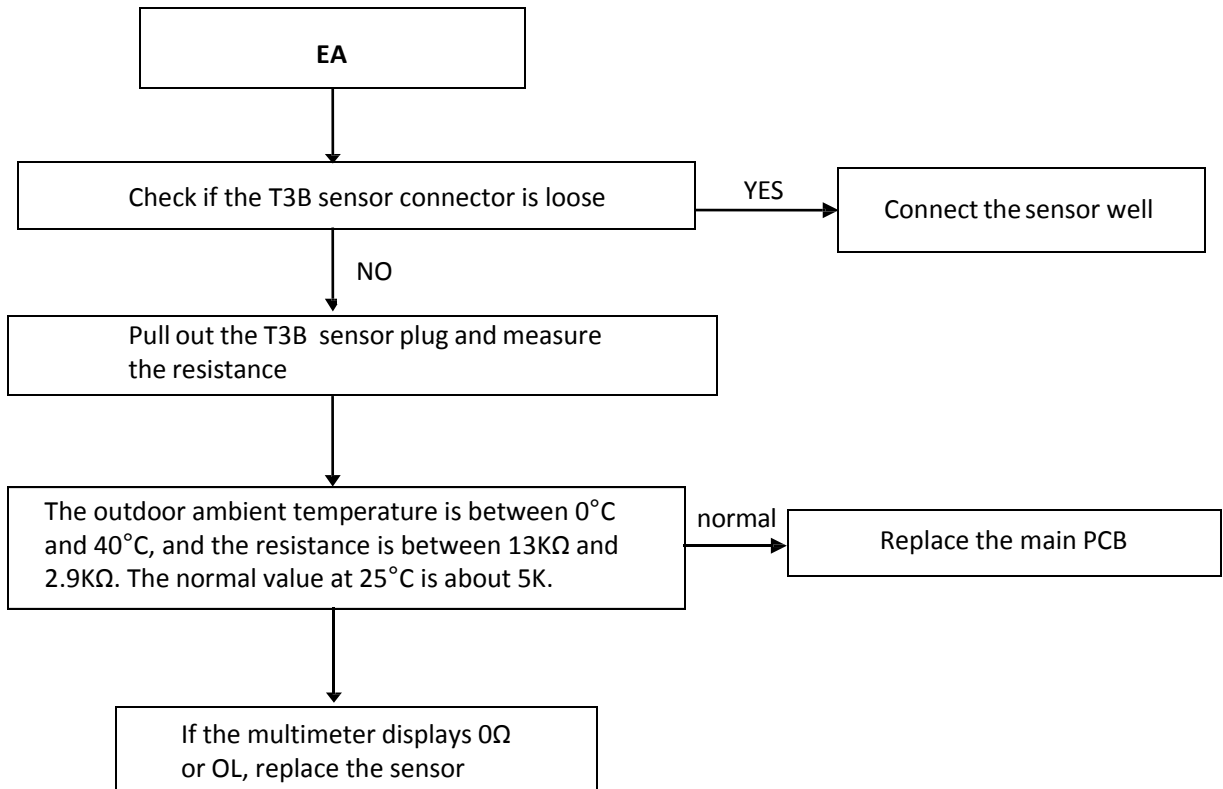

## 5.10 Eb: T6 refrigerant cooling panel temperature sensor fault or temperature protection

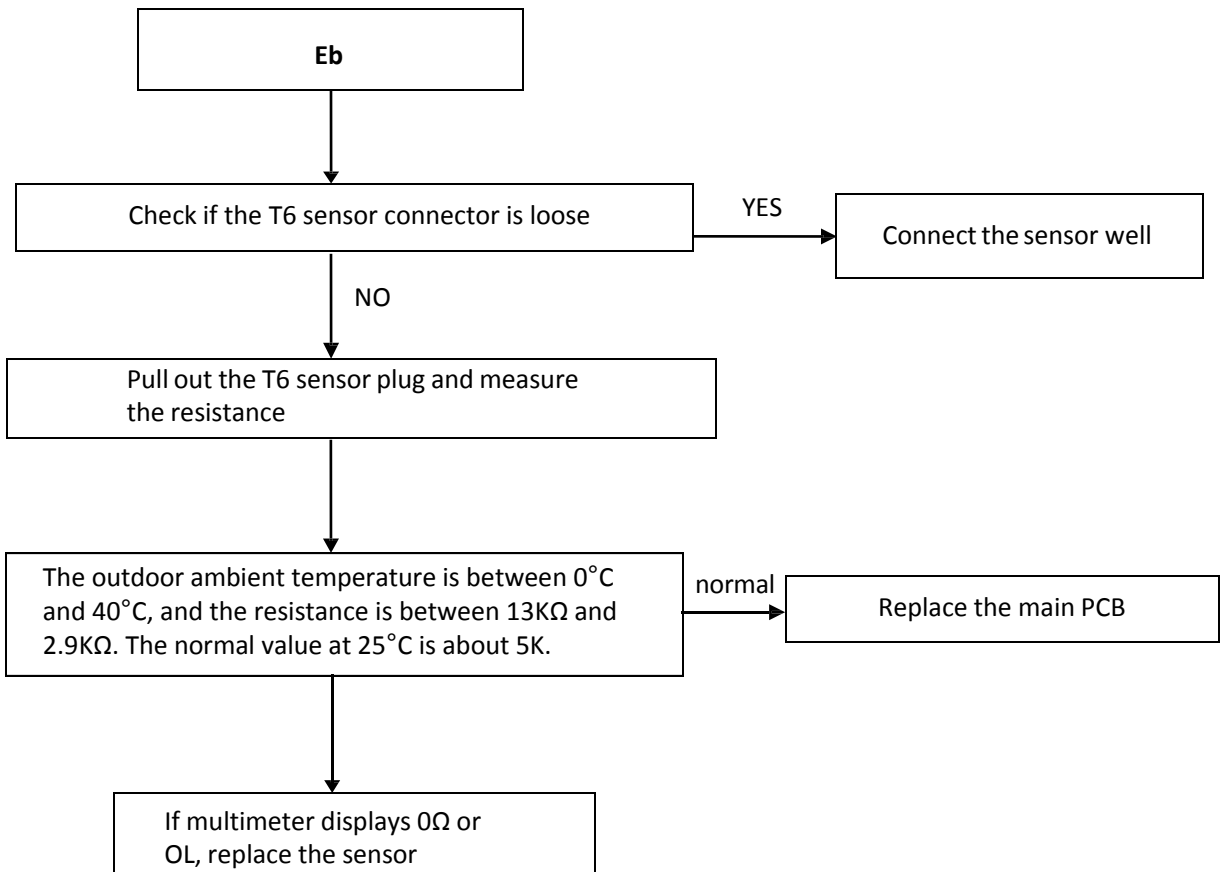



5.11 EC: T7 refrigerant cooling pipe inlet temperature sensor fault

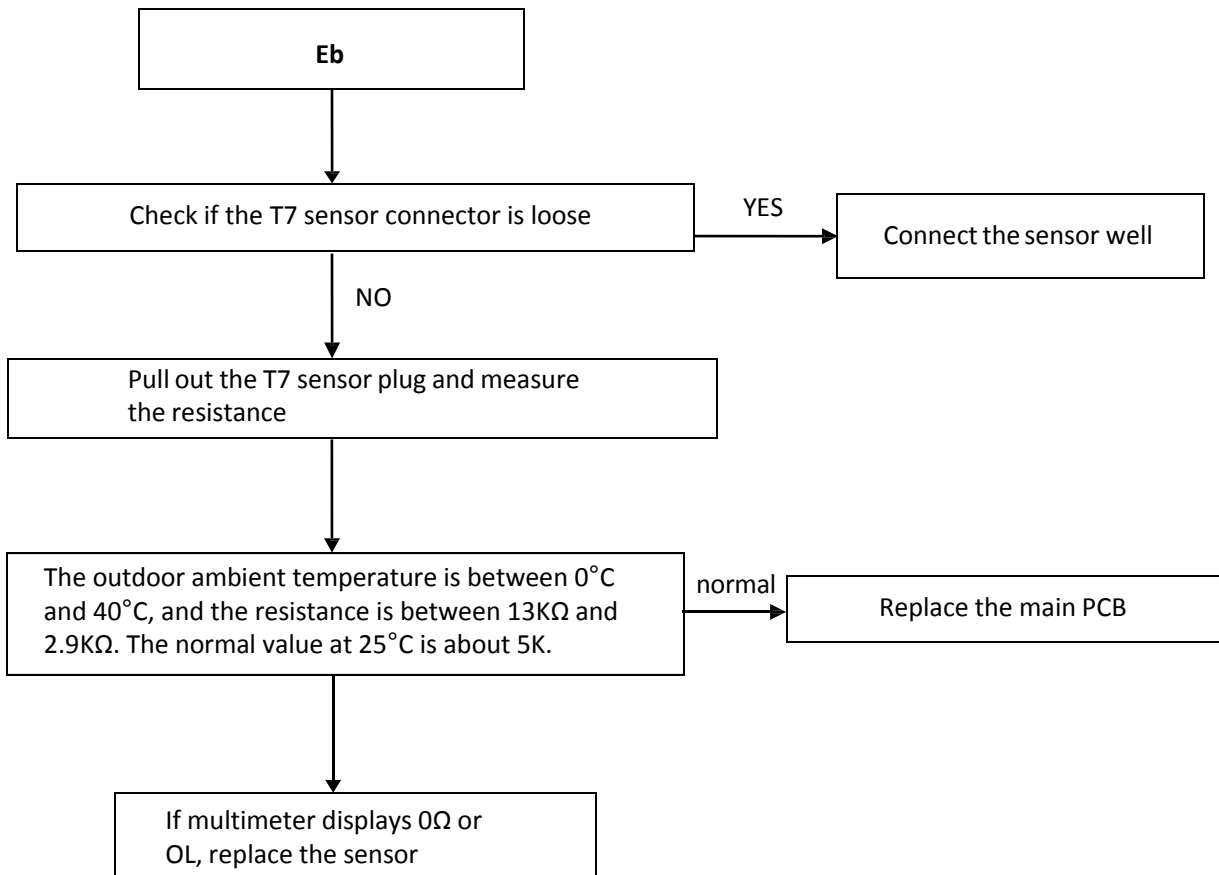

5.12 E.E: Model error(there is no dialing model in the EEOPROM)

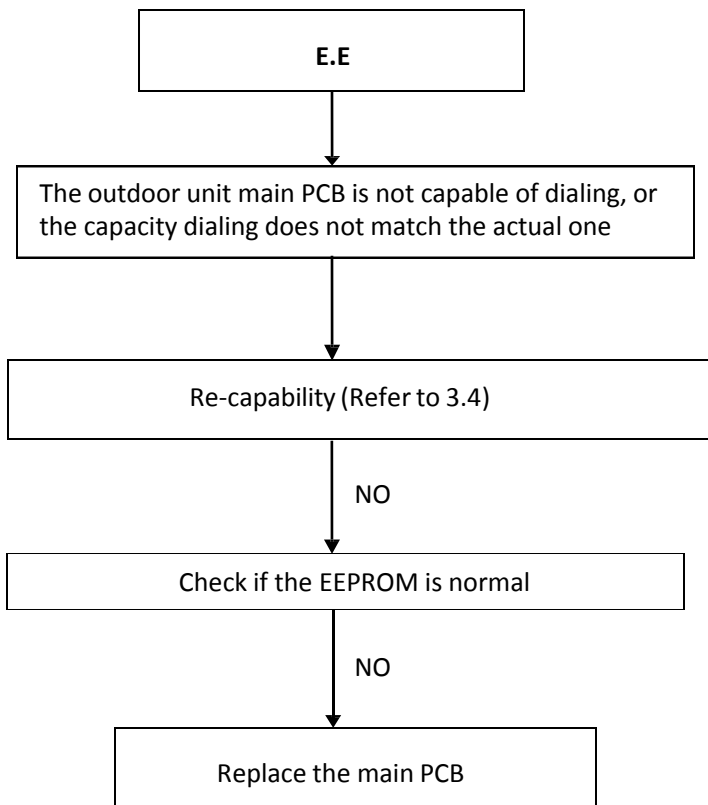

## 5.13 H0: Communication fault of master board and driver chip

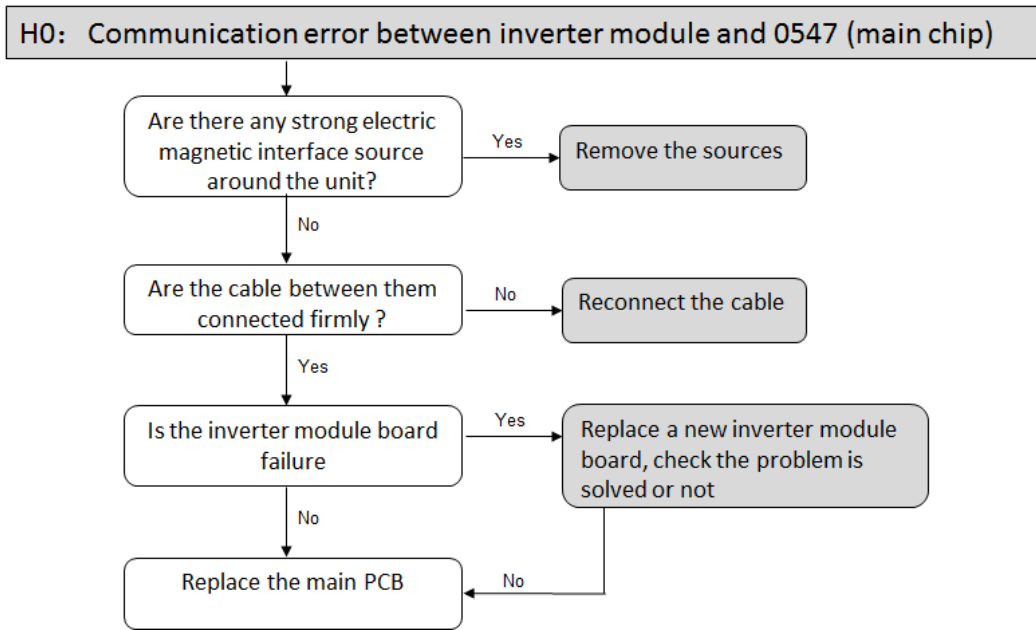

## 5.14 H4: Display P6(IPM module protection) for 3 times within 30 minutes

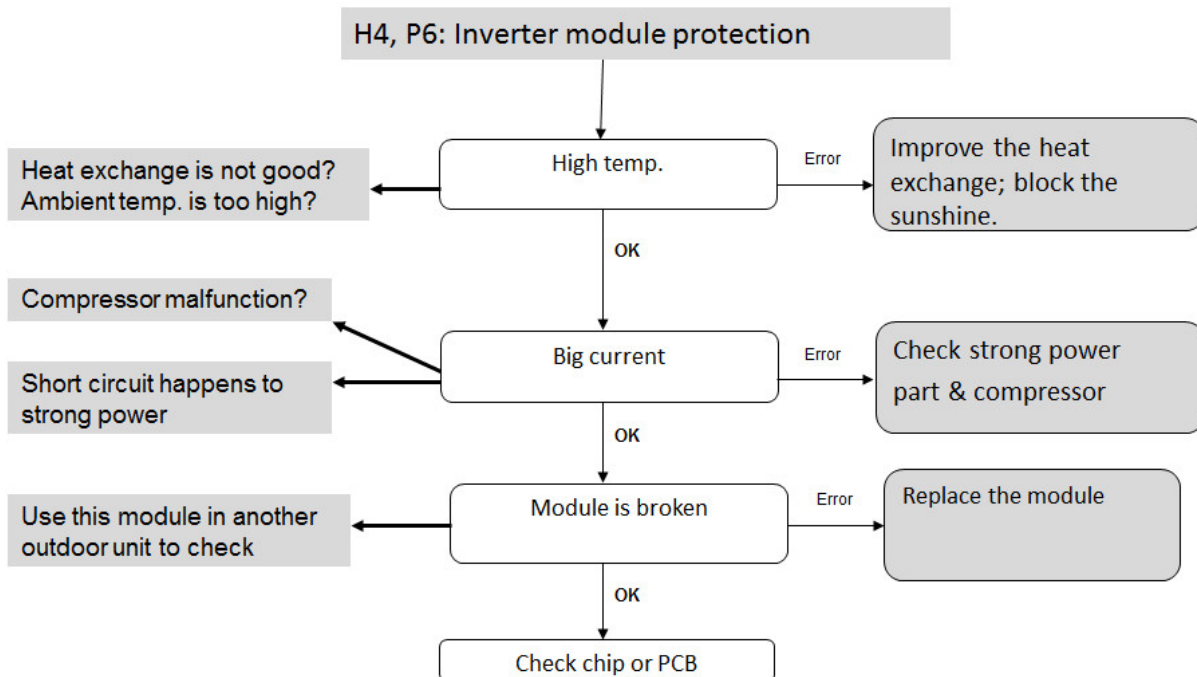

5.15 H5: Display P2 (system pressure is too low) protection for 3 times within 30 minutes

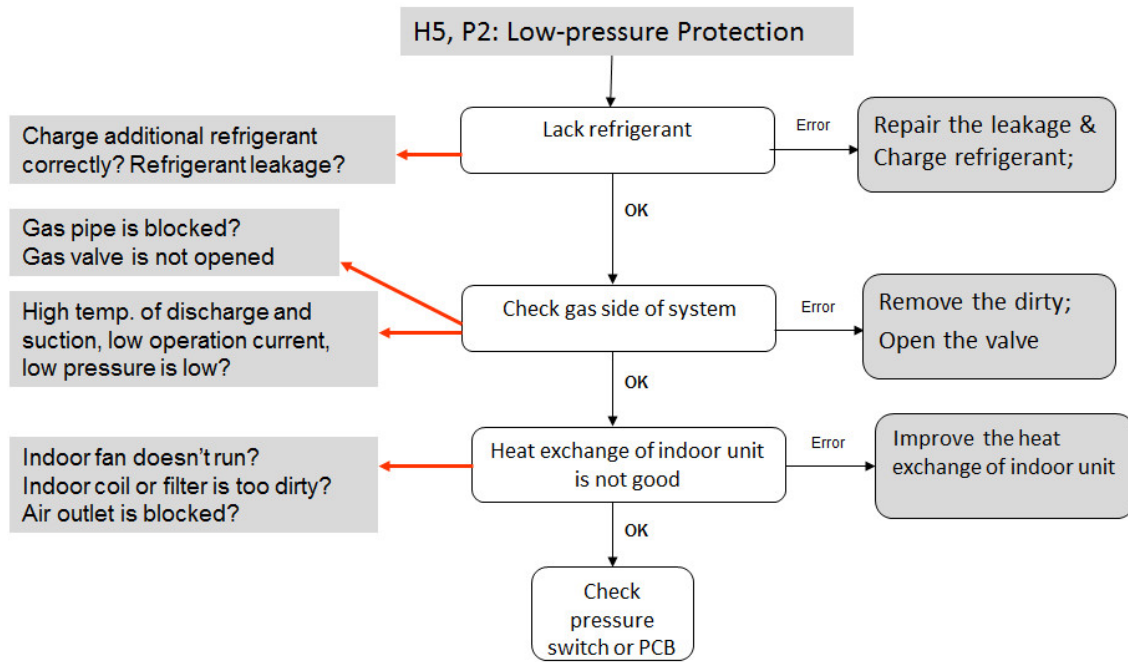

5.16 H6: Display P4 (T5 Exhaust temperature is too high ) protection for 3 times within 100 minutes

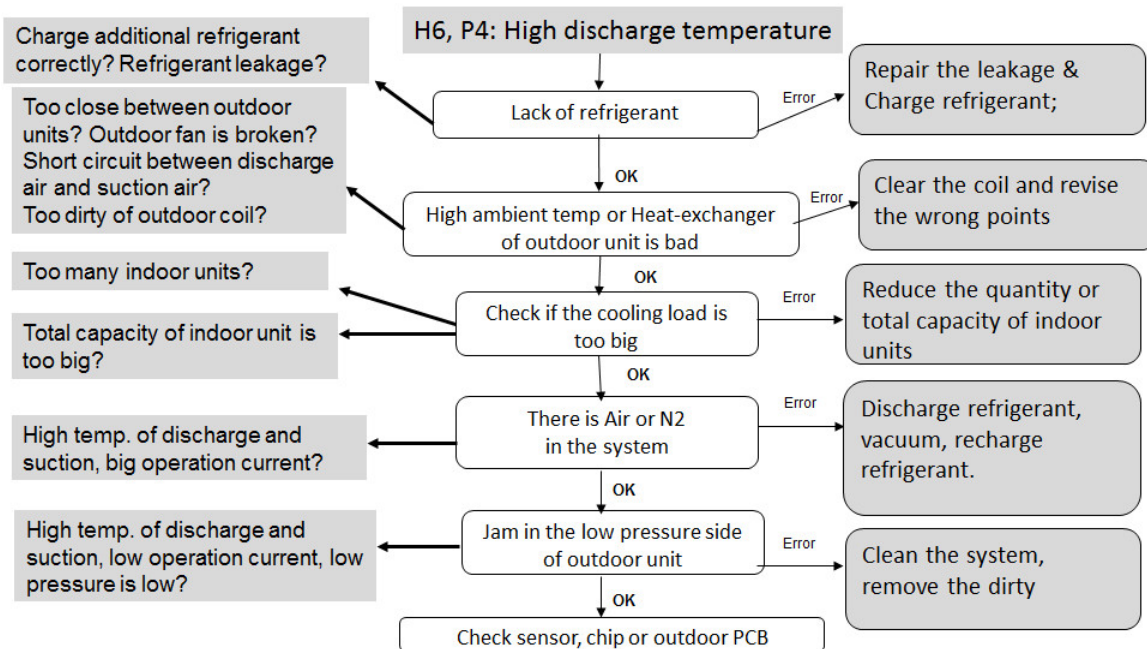

## 5.17 H7: The decrease in number of indoor unit

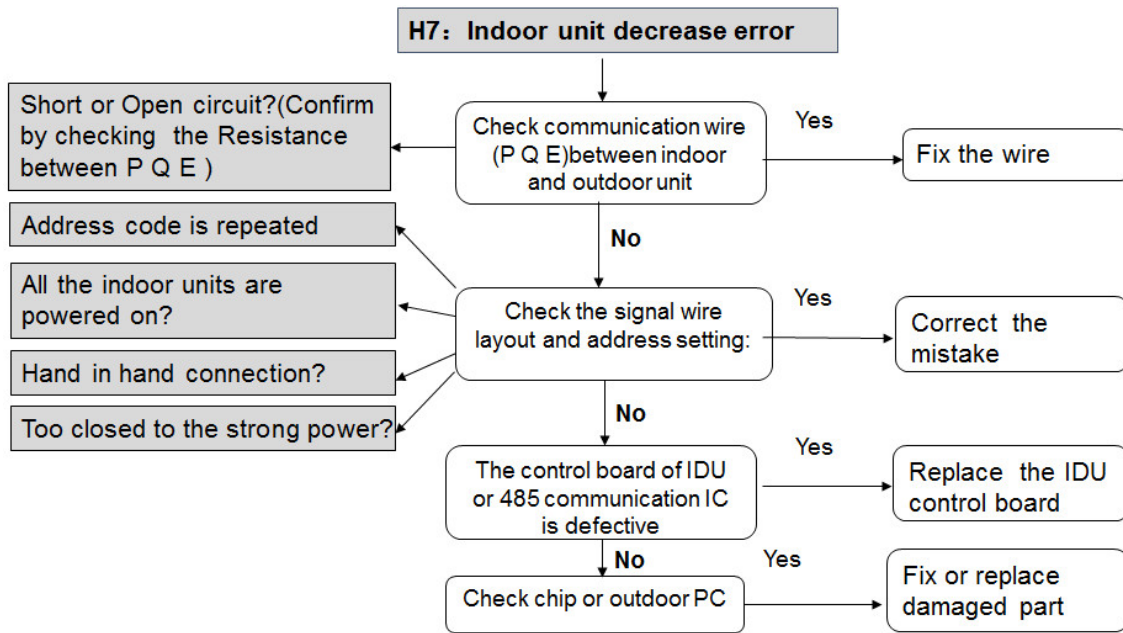

## 5.18 H9: Display P9 (AC fan fault ) protection for 2 times within 10 minutes

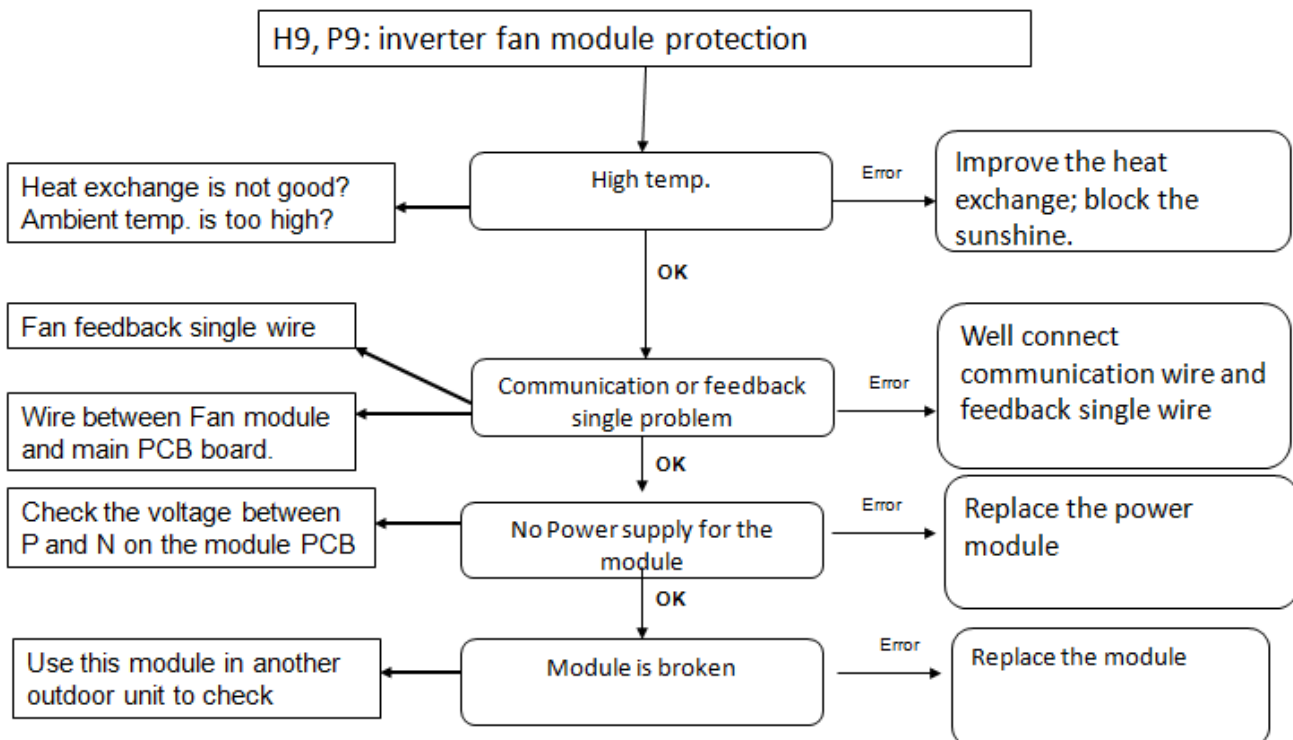

5.19 H10: Display P3(inverter over current protection) protection for 3 times within 60 minutes

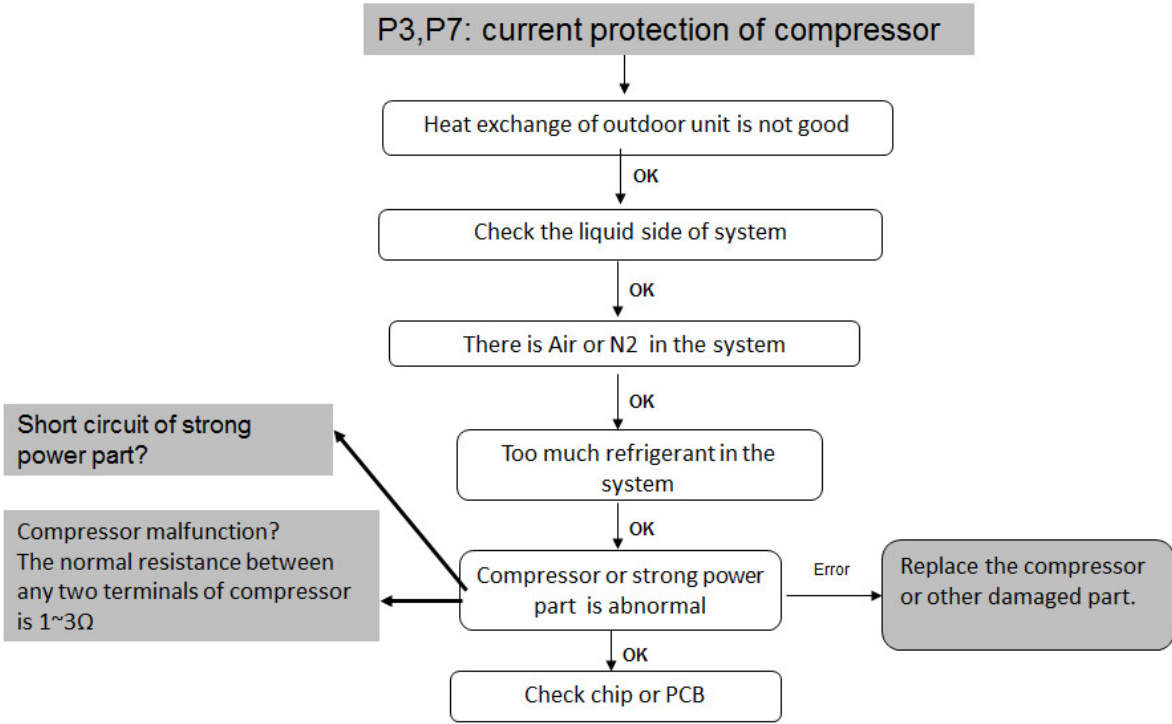

5.20 H11: Display P13 protection for 2 times within 10 minutes

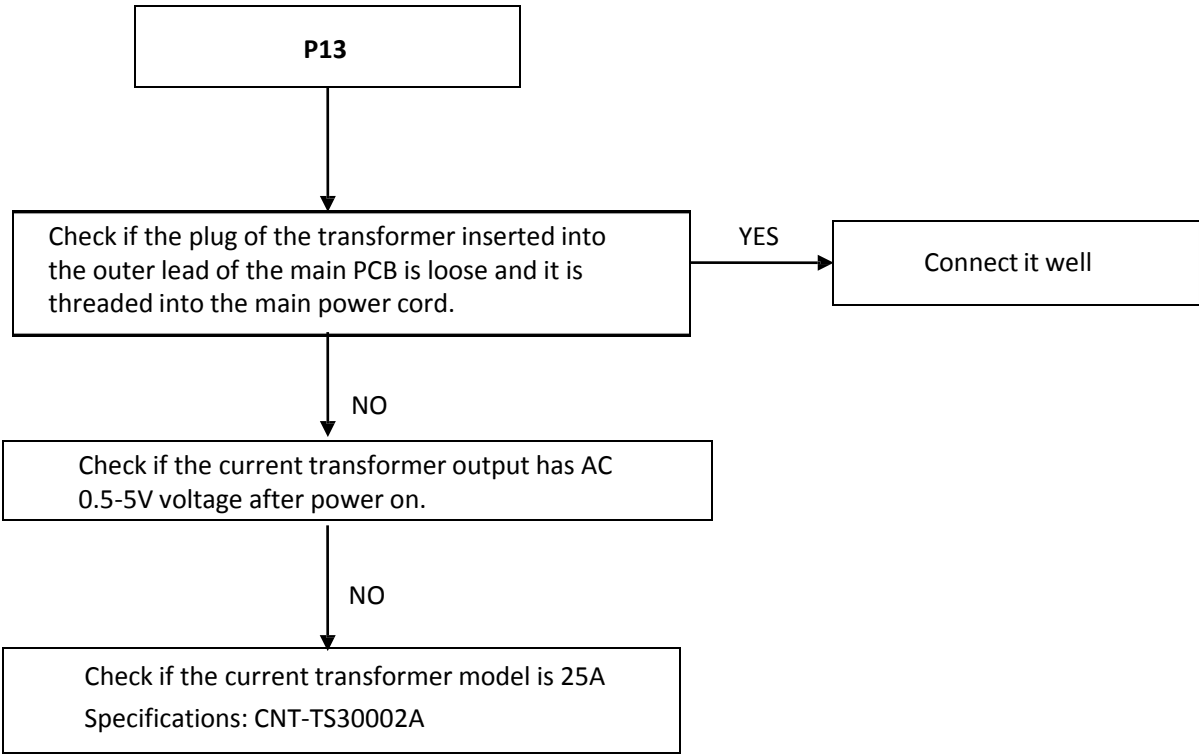

## 5.21 P1: High pressure

### protection

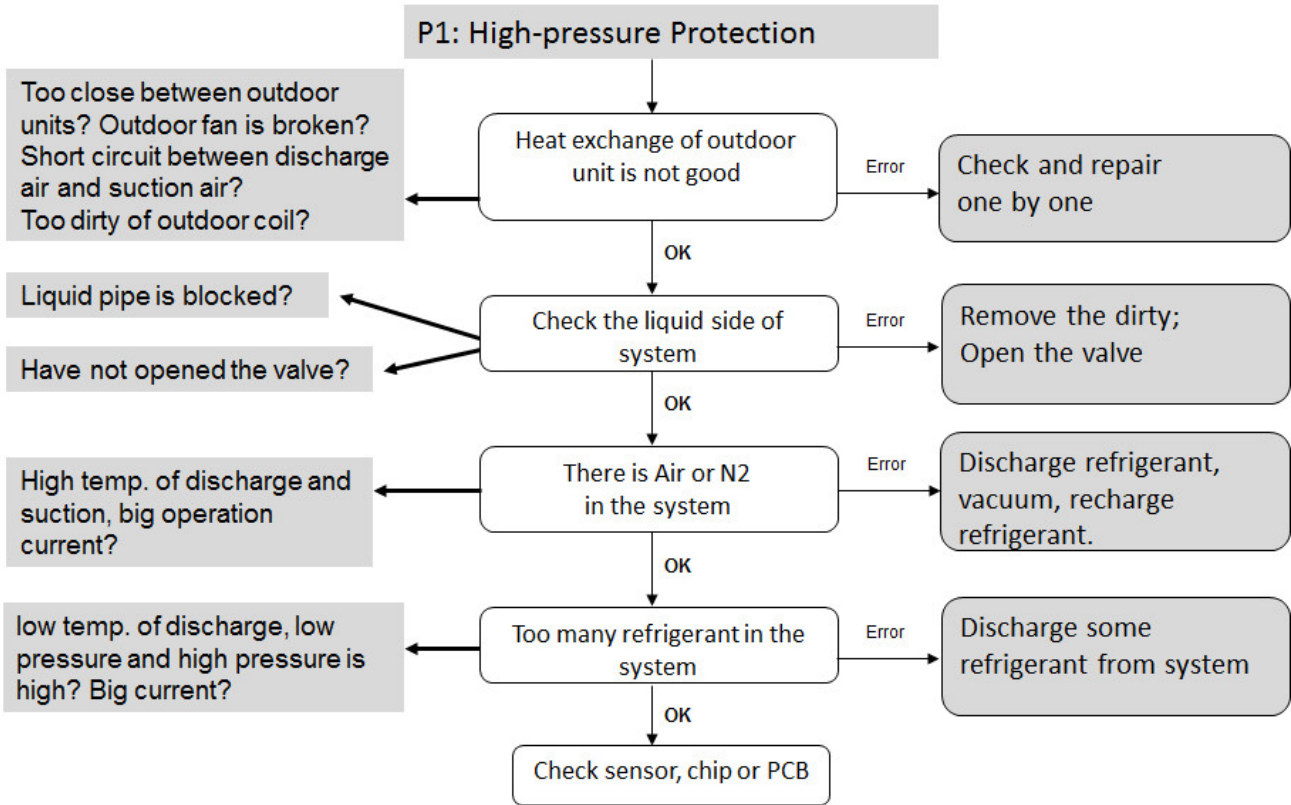

## 5.22 P2: Low pressure protection

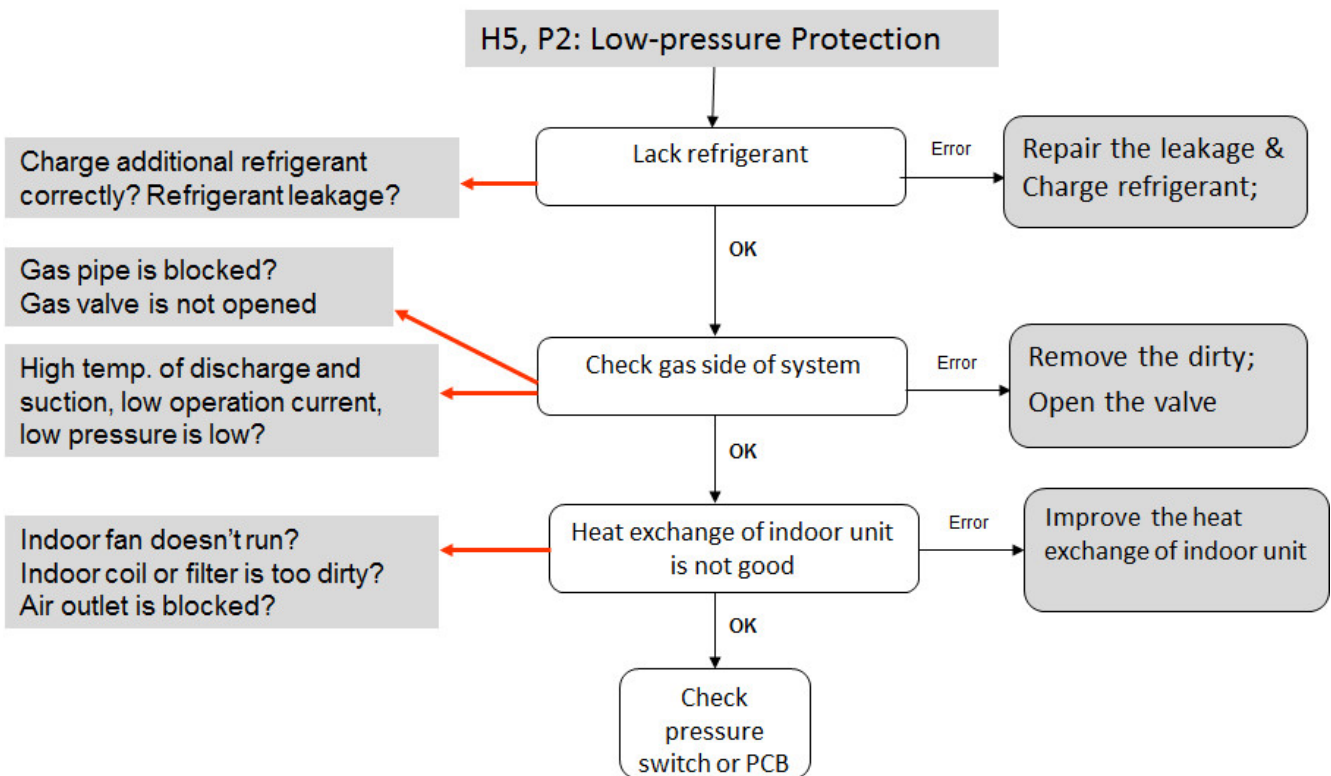



5.23 P3: Inverter over current protection

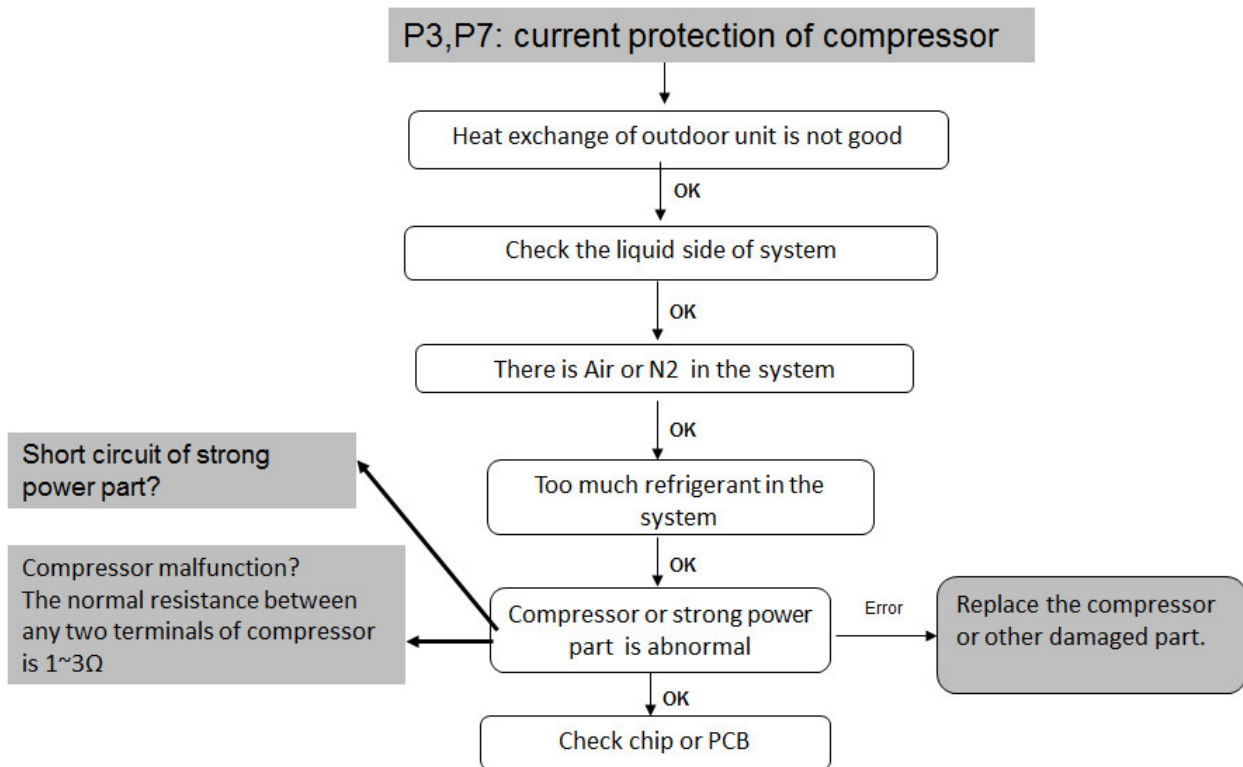

5.24 P4: Exhaust overheating protection

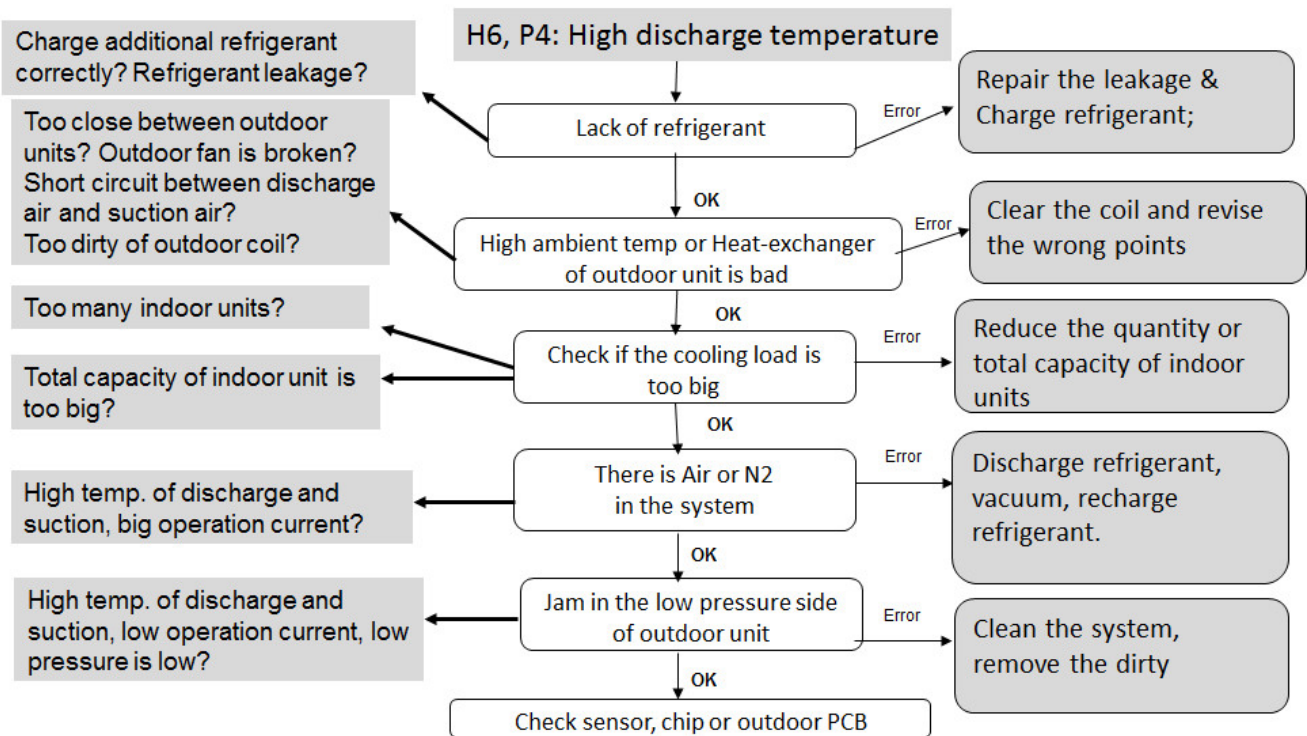

5.25 P5: T3 or T3B condenser pipe overheating protection

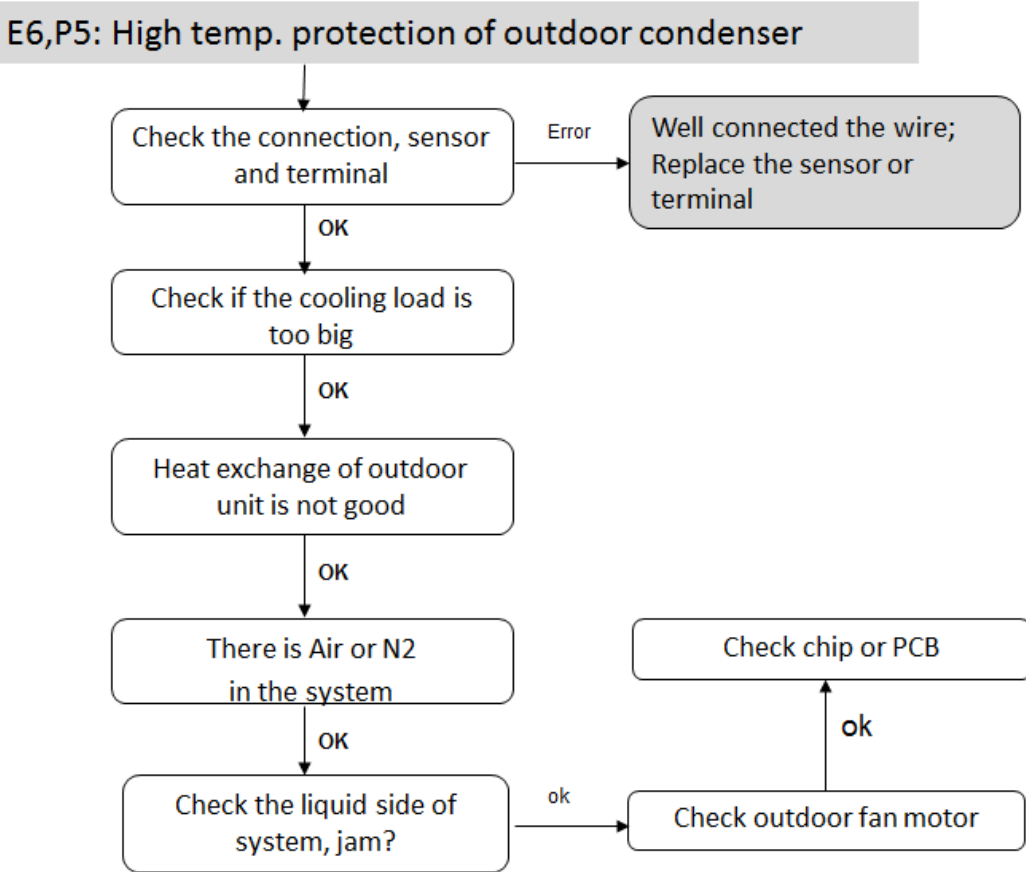

5.26 P6: IPM protection

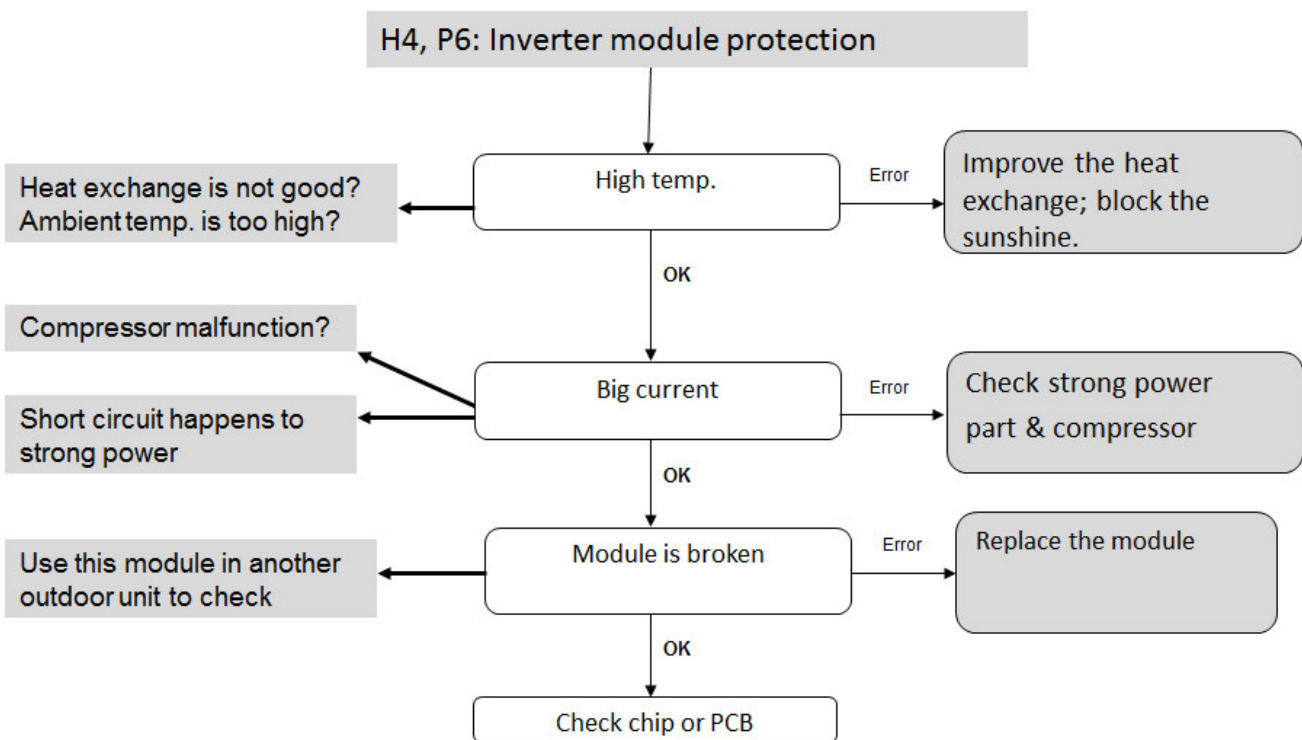



Code	Malfunction or protection	remark
L0	Inverter compressor malfunction	After P6 displaying for 60s, these L error codes will display.
L1	DC generatrix low voltage protection	
L2	DC generatrix high voltage protection	
L3	reserved	
L4	MCE malfunction/simultaneously/cycle loop	
L5	Zero speed protection	
L6	reserved	
L7	Wrong phase protection	
L8	Speed difference >15Hz protection between the front and the back clock	
L9	Speed difference >15Hz protection between the real and the setting speed	

Please Check L error code for the solution.

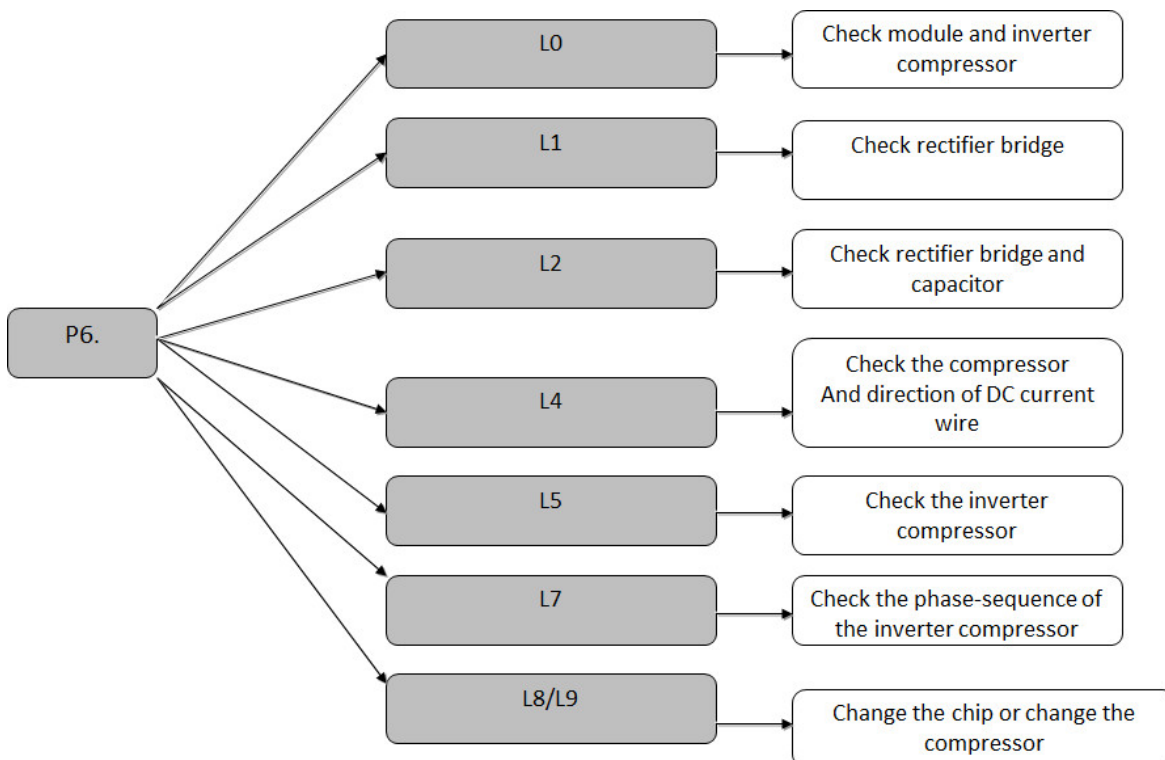

## 5.27 P9: DC fan fault

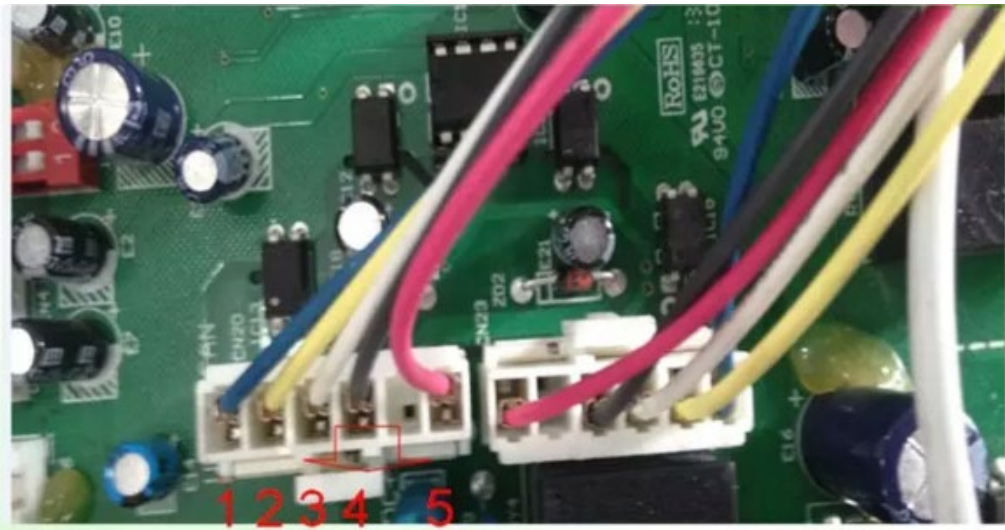
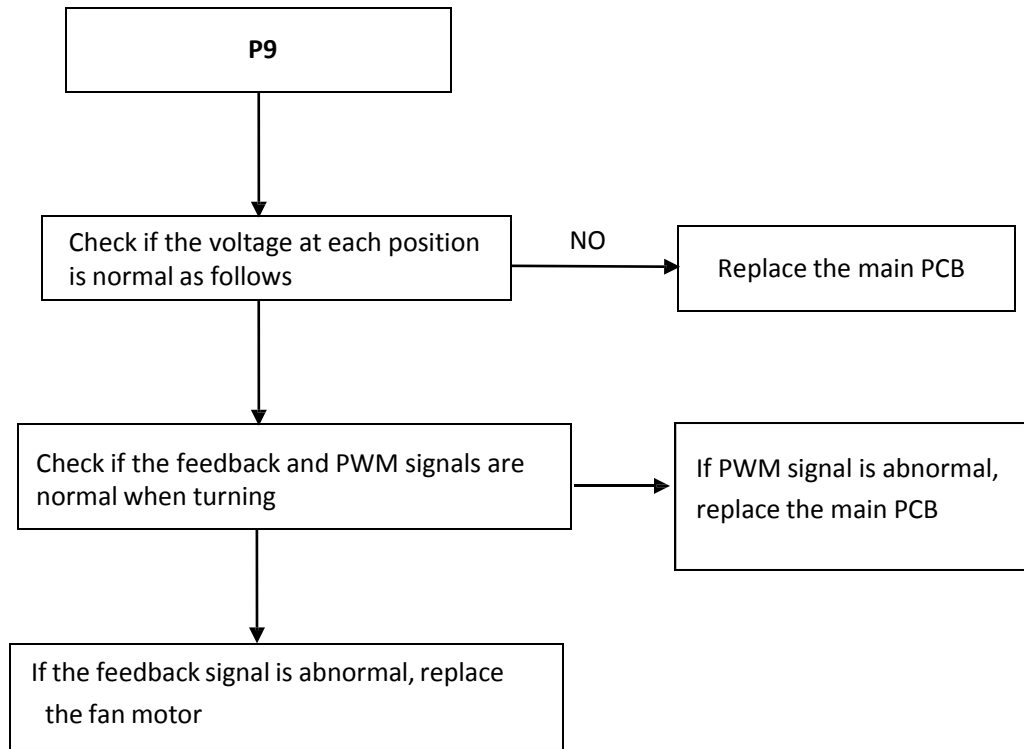

No.	Name	Remarks
1	Fan motor feedback port	OFF: 0V; ON: DC 1.4-7V
2	PWM port	OFF: 0V; ON: DC 2.8-6.4V
3	15V power supply	
4	DC 310V and DC 15V GND	
5	DC 310V	Single phase: 380V; three-phase: 310V

### 5.28 P10: Anti-typhoon protection

(1) Enter this condition:

- a) The fan has stopped output for several minutes;
- b) The current speed detected by the fan is  $\geq 400$ rpm.

(2) Exit this condition:

- a) After several minutes of anti-typhoon protection;
- b) The fan detects the current speed  $< 400$ rpm.

In order to prevent the software from controlling the fan to stop, the fan continues to rotate due to external force or electronic control internal signal interference. At this time, if the outdoor unit has no external force to rotate, it can be determined that it is an outdoor main PCB problem.

### 5.29 P11: T2 high temperature protection when heating

(1) How it works:

- a) When T2 averages  $> 63^{\circ}\text{C}$  for a period of time, stop the compressor and display error code P11 for at least 30s;
- b) When T2  $< 50^{\circ}\text{C}$ , the protection is released. The compressor's three-minute delay protection is effective.

(2) Effect:

Prevent the four-way valve from being powered down and not recovering, jamming, or inserting the wrong end of the four-way valve.

(3) Solution:

When checking the cooling, the four-way valve coil is still energized. If yes, please check if there is any problem with the coil wiring. If not, proceed to the next step.  
Check if the four-way valve is normal or not, and if the valve body is stuck.

### 5.30 P12: T3 overheating protection

Under normal circumstances, the outdoor pipe temperature of T3 will decrease when heating, and it will not be too high, so it will not continue to be higher than 24 degrees under normal conditions. At this time, it will prove that the probe temperature is not accurate or the probe senses the ambient temperature.

### 5.31 P13: Current detection error protection

Primary side current detection abnormal protection: 3 to 5 minutes after the compressor starts, if the primary side current  $< 1.5\text{A}$ , the current transformer fault (P13) is displayed, the compressor stops automatically for a period of time, and it appears three times in 30 minutes. the electricity is not recoverable and the H11 is displayed.

### 5.32 L0: DC compressor module fault

(1) Over current protection(auto-recover): Lights flash once every 3s.

Solution: Usually caused by bad outdoor unit heat exchanging condition, improve the heat exchanging condition. Otherwise, check if the outdoor ambient temperature sensor has a resistance offset. If the resistance value is offset, replace the sensor.

(2) Over load protection (auto-recover): Lights flash 4 times every 3s.

Solution: Usually caused by bad outdoor unit heat exchanging condition, improve the heat exchanging condition. Otherwise, check if the outdoor ambient temperature sensor has a resistance offset. If the resistance value is offset, replace the sensor.

(3) Over heat protection (auto-recover): Lights flash 5 times every 3s.

Solution: Check if the module board heat sink is cooled properly, check if the thermal silicon on module board is coated evenly, thermal silicon on module board must be coated evenly after replacing module board.

### 5.33 L1: DC cable bus low voltage protection

(1) Measure the voltage of "POWER-N" on the adapter board and check if there is output (normal 220V), if there is no 220V output, replace the main control board, otherwise proceed to the next step.

(2) Check if the AC contactor of the inverter compressor is closed, if there is no suction, replace the AC contactor, otherwise proceed to the next step.

(3) When the inverter compressor starts, use the DC gear to measure the voltage of the input-output terminal of the AC contactor of the inverter compressor (normal value is 0V, if 530V is false suction), if the voltage value rises rapidly to 530V when the compressor starts, replace the AC contactor. If the voltage value does not rise and the L1 fault is reported, replace the compressor module board.



### 5.34 L2: DC cable bus high voltage protection

(1) Measure the power supply. If the power phase voltage exceeds 265V, it is likely to report L2.

(2) If the power input voltage exceeds 265V, it is required to rectify the power supply. If the voltage is normal, replace the compressor module board.



**5.35 L4: MCE fault / sync / closed loop**

(1) Check if the DC bus voltage is normal: 510-580V, if it is less than 510V, go to check the rectifier circuit.

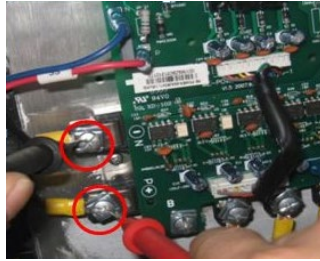

(2) Check if the wiring of the rectifier circuit is correct, and confirm that the plug is not loose or the like.

(3) If the rectifier circuit troubleshooting machine still does not start, please replace the main control board.

**5.36 L5: Zero speed protection**

Check if the compressor power wire is connected. If there is a problem with the inverter compressor wiring, correct the wiring method, otherwise replace the module board.

**5.37 L7: Compressor phase loss protection**

(1) Check if the compressor power cord "U, V, W" is connected counterclockwise.

If there is a problem with the inverter compressor wiring, correct the wiring method, otherwise proceed to the next step.

(2) Check if there is any phase loss in the power wire of each phase of the inverter compressor.

If the inverter compressor power wire is loose, reconnect it, otherwise replace the compressor module board.

**5.38 L8: Protection when the speed change at the previous moment and the latter moment is greater than or equal to 15Hz**

Observe the compressor starting process. If it is just starting, the frequency will not fluctuate when running 36Hz.

When it rises, it will fluctuate, then the compressor will demagnetize and replace the compressor. (Replace the compressor, check that the compressor oil is clean and clean the vapor-liquid separator)

**5.39 L9: Protection when the difference of set speed and actual operation speed is greater than or equal to 15Hz**

Replace the module board.

### 5.40 Pb: T6 refrigerant cooling panel temperature is too high

Check the 12th and 13th parameters of the main control board. If the value is  $\geq 85^{\circ}\text{C}$ , the outdoor unit will stop and report Pb protection.

(1) Poor heat dissipation of the outdoor unit:

Solution: Improve the heat dissipation conditions of outdoor units (especially at the heat sink fins).

(2) Insufficient system refrigerant:

Solution: Replenish refrigerant to ensure normal refrigerant volume.

(3) Air/nitrogen mixed in the system:

Solution: Release all the refrigerant and re-vacuum to flush the refrigerant; if there is frozen oil released, it needs to be replenished with some refrigeration oil.

(4) T6 refrigerant heat sink temperature sensor failure:

Solution: Measure the resistance value of the T6 refrigerant heat sink temperature sensor ( $5\text{K}\Omega/25^{\circ}\text{C}$ ) to check if resistance drift occurs. Replace the sensor if the resistance value is offset.

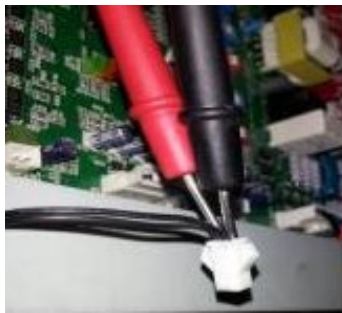



**OMEGA**  
ENVIRONMENTAL  
TECHNOLOGIES LLC.

17702 Mitchell North, #101  
Irvine, CA. 92614 .USA  
Tel: 714 795 2830 Fax: 714 966 1646  
info@oetusa.com  
www.omegaenvironmentaltechnologies.com

**OTEC**<sup>TM</sup>  
AIR CONDITIONING

**Showroom & Technology Center**  
11380 Interchange Circle North  
Miramar, FL 33025 .USA  
Tel: 305 901 1270  
Fax: 954 212 8280  
info@otecus.com  
www.otecus.com